



Parflex[®] Thermoplastic Hose, Tubing, Fittings and Accessories

Catalog 4660-WEB
August 2007



The World Standard

Welcome to ... The Parflex Division

The Parflex Division, part of the Fluid Connectors Group, includes the Ravenna facility in Ohio, a hose assembly facility in Stafford, Texas, a hose manufacturing plant in Manitowoc, Wisconsin, and a PTFE hose production plant in Mansfield, Texas. The Parflex Division is responsible for the manufacture of thermoplastic hose, tubing, hose bundles, harnesses, high pressure hose assemblies, fluoropolymer hose and tubing.

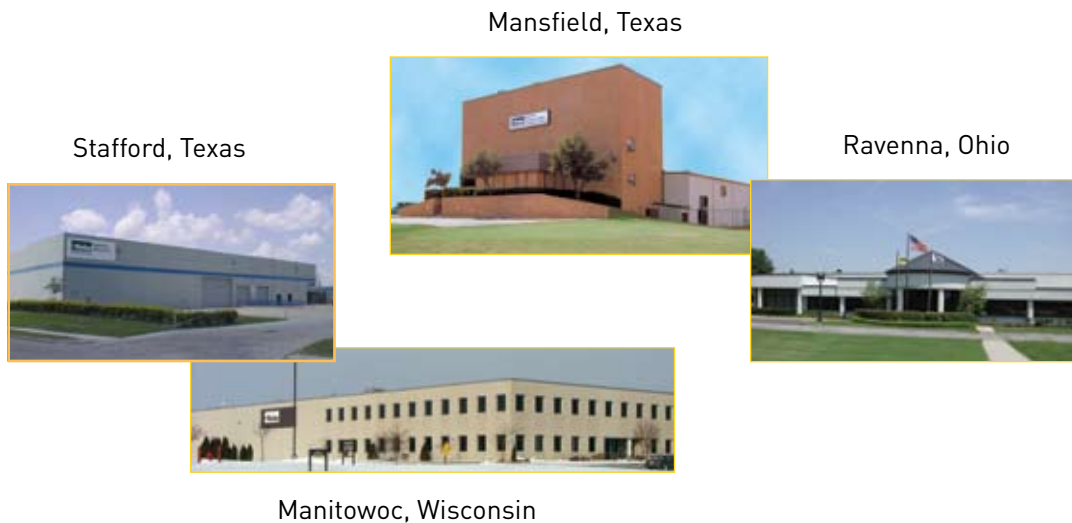

The Charter of the Parflex Division is:

"To be the global leader in engineered polymer-based products, and to provide system solutions for the conveyance and control of fluids."

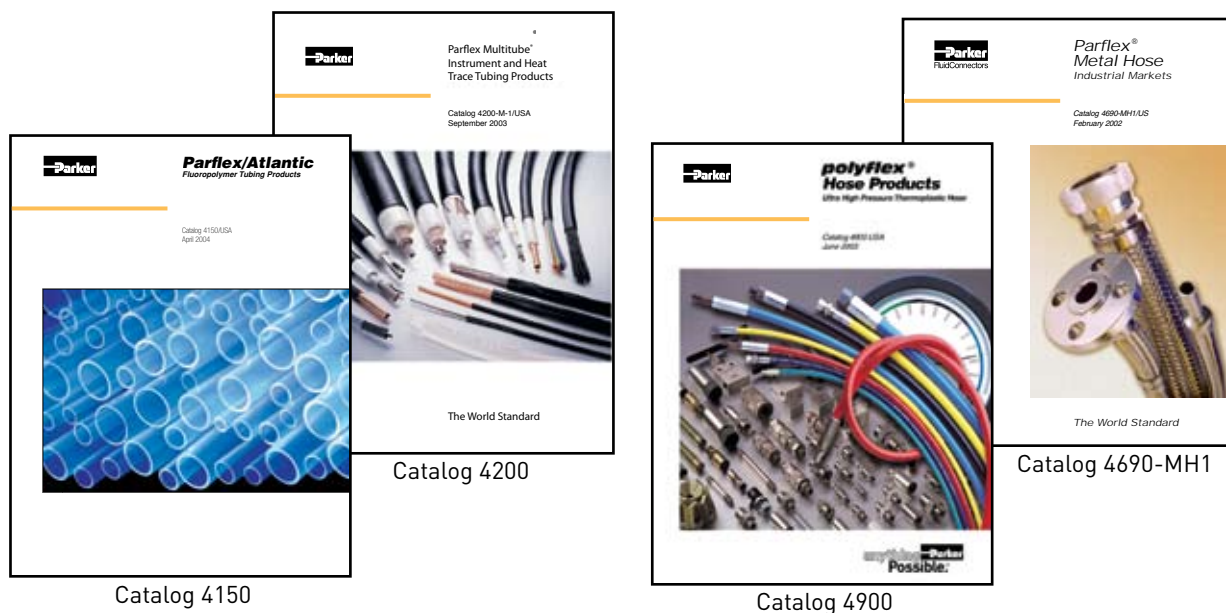

For information on products not contained in this catalog please contact Catalog Services at 440.205.7799 for copies of these additional Parflex products.



Parker Hannifin Corporation
Parflex Division
Ravenna, Ohio

Thermoplastic Hose, Tubing, Fittings and Accessories

Hydraulic & Pneumatic Hose & Fittings 1-128

PTFE Hose & Fittings..... 129-170

Thermoplastic Tubing..... 171-194

Coiled Air Hose, Fittings & Accessories..... 195-206

Truck (Fleet) Products 207-214

Tooling & Equipment 215-226

Hose Accessories..... 227-232

Technical & Design Information 233-296

Approvals & Guides..... 291-295

Alphanumeric Part Number Index 297-299

Offer of Sale300

Extra care is taken in the preparation of this literature but Parker is not responsible for any inadvertent typographical errors or omissions. Information subject to change without notice. The information in this catalog is only accurate as of the date of publication. For a more current information base, please consult the Parker Parflex Division web site at www.parker.com/parflex.

 **WARNING**

FAILURE OR IMPROPER SELECTION OR IMPROPER USE OF THE PRODUCTS AND/OR SYSTEMS DESCRIBED HEREIN OR RELATED ITEMS CAN CAUSE DEATH, PERSONAL INJURY AND PROPERTY DAMAGE.

This document and other information from Parker Hannifin Corporation, its subsidiaries and authorized distributors provide product and/or system options for further investigation by users having technical expertise. It is important that you analyze all aspects of your application and review the information concerning the product or system in the current product catalog. Due to the variety of operating conditions and applications for these products or systems, the user, through its own analysis and testing, is solely responsible for making the final selection of the products and systems and assuring that all performance, safety and warning requirements of the application are met.

The products described herein, including without limitation, product features, specifications, designs, availability and pricing, are subject to change by Parker Hannifin Corporation and its subsidiaries at any time without notice.

Offer of Sale













The items described in this document are hereby offered for sale by Parker Hannifin Corporation, its subsidiaries or its authorized distributors. This offer and its acceptance are governed by the provisions stated in the "Offer of Sale".



What's new in the 4660 catalog?

- Index bleed tabs with product /section names (replaces letter designations)
- Specific page references for selected products and information
- Predator® Hoses and complete Hybrid Hose offering
- Hose Products Division section listing HY fittings (for reference purposes only)
- Soft metric conversions shown for metal hose fittings, hydraulic and PTFE hoses
- Separated hydraulic and PTFE fittings sections
- Visual indexes for all metal fittings
- Navigation / tutorials assist user in locating product (select product lines)
- Hose descriptions and tabular information simplified / reformatted
- Larger and easier- to- read hose tables
- Dies and series of fittings indicated in individual hose tables
- Quick reference pages for selecting hydraulic hoses
- Quick reference pages for thermoplastic tubing (includes BPD)
- New hose and fitting nomenclature tables
- Plus signs replaces shading for non-standards (non standard clearly defined)
- Updated and enhanced technical section
- Condensed and easy-to-follow hose assembly guide for all hoses
- Separated tooling/equipment and hose accessories sections
- Divisional references for additional products, information, and accessories
- New HTC hose and tubing cutter
- New MiniKrimp® Stand
- Updated Air-Over-Hydraulic MiniKrimp
- High Durometer AUFS Assemblies
- New Weld Tubing
- Updates on many currently supplied hoses
- Dual Seat call-outs clearly noted
- New DuraMax Hose
- New High Temperature Fuel Lines
- New HLB Lube line Hose

Definition of Symbols Used in Tables

Symbol	Definition	Symbol	Definition
#	Part Number		Minimum Burst Pressure
	Hose Inner Diameter		Weight
	Hose Outer Diameter		Vacuum Rating
	Working Pressure		Thread Size
	Crimp Die		Hex Size
	Minimum Bend Radius		Diameter
	Crimp Fitting		Field Attachable Fitting
(+)	Non-Standard		

(+) Non-Standard

- Non-standards are not typically stocked.
- Minimum buys, runs, costs, lead times, and pricing will be quoted
- Overruns or excess inventories may exist – in-stock pricing will be quoted
- In-stock pricing levels are sensitive to products available and are subject to prior sale
- Delivery or lead times quoted begin A. R. O (after receipt of order)

The Part # column for hydraulic fittings indicates material type. Where applicable, “B” indicates Brass and “C” indicates Stainless Steel. See the “How To Order” section for more information.

For detailed ordering information, please consult price list or contact Parflex Division.

Hydraulic & Pneumatic Hose & Fit.

PTFE Hose & Fittings

Thermoplastic Tubing

Coiled Air Hose, Fittings & Accessories

Truck (Fleet) Products

Tooling & Equipment

Hose Accessories

Technical & Design Information

Approvals & Guides

Alphanumeric Index

Lined area for notes, consisting of horizontal lines across the page.



Hydraulic & Pneumatic Hoses

Hose	Description	Page
Hydraulic Tutorial and Information		3-5
Hose Selection Guide		6
Hose Rated Pressures PSI.....		7
Hose Assembly & Fittings Nomenclature		8
B9	- General Purpose Fuel Transfer	9
D6	- Constant Pressure Hybrid 3000 PSI.....	9
H6	- Constant Pressure Low Temperature 3000 PSI.....	10
HFS	- Firescreen® Hybrid	11
HFS2	- Firescreen II® Hybrid	11
HTB	- Eliminator® Compact Hybrid	12
M8	- E-Z Flex® Hybrid Constant Pressure 4000 PSI	12
R6	- Abrasion King® Constant Pressure 3000 PSI	13
560	- General Hydraulic	14
563	- General Hydraulic	14
590	- General Hydraulic	15
593	- General Hydraulic	15
510A	- Refrigerant	16
510C	- General Hydraulic	17
515H	- Compact/Lightweight.....	17
518C	- Non-conductive Hydraulic	18
520N	- General Hydraulic	19
528N	- Non-conductive Hydraulic	19
53DM	- DuraMax™ Low Temperature Constant Pressure 3000 PSI.....	20
53LT	- Low Temperature Constant Pressure 3000 PSI.....	20
538LT	- Non-conductive Low Temperature Constant Pressure 3000 PSI.....	21
540N	- General Hydraulic	22
55LT	- Low Temperature	23
573X	- Fast Response 3000 PSI.....	23
575X	- Fast Response 5000 PSI.....	24
580N	- High Pressure Hose 2000 to 5000 PSI Range	24
H580N	- High Pressure Hose 2000 to 5000 PSI Range	24
588N	- High Pressure, Non-Conductive Hose 2000 to 5000 PSI Range.....	25
83FR	- General Purpose Air & Water, Flame Resistant.....	26

Specialty Hoses

HJK	- Highjack® Jackline Hybrid.....	26
53GW	- Grease Whip Hose	27
HLB	- Lubrication Line	27
HPS	- Paint Spray	28
MSH	- Marine Steering.....	28

Specialty Hoses

PTFE Hose & Fittings	MTH	- DOT Marine Trailer Hose	29
	PTH	- Marine Power Tilt.....	29
Thermoplastic Tubing	S4	- Predator® Water Jetting/Lateral Cleaning Hose 4000 PSI	30
	S5	- Predator® Water Jetting/Lateral Cleaning Hose 4000 PSI	30
	S6	- Predator® Sewer Cleaning Hose 2500 PSI	31
	S9	- Predator® Sewer Cleaning Hose 3000 PSI	31
	3CNG	- Compressed Natural Gas 3600 PSI	32
	4CNG	- Compressed Natural Gas 4000 PSI	32
	5CNG	- Compressed Natural Gas 5000 PSI	32
	526BA	- Breathing Air Refill Hose	33
	540P	- Specialty Water	33
	56DH/568DH	- Diagnostic Hose	34
Coiled Air Hose, Fittings & Accessories	1035A	- Power Cleaning	35
	1035HT	- Power Cleaning	35
	Twin-Line and Multi-Line		36
	Retractable Coiled Hose		36
	Hose Bundles, Harnesses, & Pre-formed Hoses.....		36

Permanent & Field Attachable Hose Fittings

Truck (Fleet) Products	Visual Index Permanent Fittings		37-38
	Visual Index Field Attachable Fittings		39
Tooling & Equipment	Hose Fitting Selection Guide		40
	LV Series		41
Hose Accessories	MS Series		42
	Mender/Splicers Series		43
	51 Series Field Attachable		44-46
	51 Series Metric Field Attachable		47-52
	55 Series		53-69
	55 Series Metric		70-77
	58/58H Series.....		78-94
	58 Series Metric		95-102
	92 Series		103-104
	BA Series		105-107
Technical & Design Information	BG Series		108-109
	SQ Series.....		110
	HY Visual Index —for reference only (HPD Product)		112-113
	HY Series —for reference only (HPD Product)		114-128
Approvals & Guides			
Alphanumeric Index			



Hydraulic Hose Tutorial

How to navigate the Hydraulic Hose portion of this section

- Familiarize yourself with the basics on thermoplastic and hybrid hoses below
- Use the **STAMPED guide** (Size, Temperature, Application, Media, Pressure, End Configuration, and Delivered Preferences) **on page 5** to help narrow your search for the desired product
- Review the **symbols on page iii** and **nomenclature information on page 8** - this will clear up any questions on assemblies, component call outs, and general definitions - examples are provided
- The **Parflex Hose Quick Guide** will help pinpoint the hose you require. It will help you identify individual hoses by:
 - 1) Brief general description
 - 2) Specific size with corresponding working pressure
 - 3) Industry specification (eg. SAE)
 - 4) Core tube material
 - 5) Reinforcement/ type of construction
 - 6) Cover Material
 - 7) Specific page number where further detailed product information can be found
- A **visual index of fittings** follows the hose portion of this section **on page 37**. This will quickly help you identify the configurations you are looking for

General Construction- Construction standards may vary between specific thermoplastic hoses. All hose layers however, are bonded to provide maximum kink resistance and flexibility through a wide range of applications. Tightly packed fiber braided reinforcement provides strength for optimum performance. Specific braid materials, wire reinforcements, spiral reinforcements, and distinguishing features are clearly called out in this section. Perforated and non-perforated hoses are available based on application.

WITH NOTED EXCEPTIONS, Parflex hoses are engineered and manufactured to a 4:1 burst pressure to working pressure ratio that follows SAE design standards. Never operate a hose beyond its published working pressure.

(Working Pressure x 4 =Minimum Burst)

Why you should choose and use Parflex® Thermoplastic and Hybrid Hoses

Listed on the following pages are the many reasons why you should consider Parflex thermoplastic hoses for your next hydraulic or pneumatic application. This summary gives an overview of the features, advantages, and benefits, in general, to our fine and extensive line of thermoplastic hoses. Each hose is described in detail within this catalog. **We urge you to review this section** before you proceed with your selection.

For additional information regarding Hose Products Division fittings, equipment or accessories please consult Catalog 4400 or www.parkerhose.com.

Thermoplastic Hoses

Specialty Hose Capability - Parflex offers many unique specialty hoses such as electrically non-conductive, breathing air, and CNG hoses to name just a few. Let us custom design and build a solution for you.

Superior Abrasion Resistance - Urethane and nylon style covers provide the industry's highest level of abrasion resistance today. They can outlast standard rubber hoses in lab tests by up to 10:1.

Long Continuous Lengths - Long length hoses reduce the number of short unusable hose lengths and thereby save money in the long run.

Clean Core Tubes - Unlike rubber core tubes, thermoplastic core tubes are clean when cut and greatly reduce the chance of contamination in today's state-of-the-art hydraulic systems.

Wide Chemical Range - Thermoplastic hoses offer a superior range of chemical resistance. Tough outer covers also resist degradation by UV rays, water and harsh wash down chemicals.

Lightweight by Design - Lightweight designed equipment is routinely being requested by leading manufacturers today. Thermoplastic hoses are considerably lighter than rubber hoses (e.g. 100R8 hose can weigh up to 40% less than a comparable 100R2 hose).

Smaller OD - Compact designs allow tighter bend radius characteristics and work well in small enveloped areas.

Easy Routing - Smooth outer covers offer ease in routing multiple hoses in tight or confined areas such as booms, lifts, and tracks.

Lower Volumetric Expansion - This means less energy loss and faster reaction time in hydraulic circuits.

UV Resistant - Parflex thermoplastic hose jackets are UV stabilized for optimal weather resistance.

Long Shelf Life - Thermoplastic hoses do not continuously cure, and won't degrade when stored under proper conditions.

Easy To Cut - Fabric reinforced hoses do not require high power saws to be cut. Simple hand or blade cutters can be used.

Crimpable, Swageable, Field Attachable - Some Parflex thermoplastic hoses can be assembled utilizing any of these three methods of fitting attachment for added convenience.

Bonded Components - Some Parflex thermoplastic hoses can be bonded together from 2 to 10 hoses, in multiple sizes and products. Similar cover materials must always be used in the bonding process.

Coiled/Retractable Capability - Many Parflex thermoplastic hoses can be coiled for retractable capability for easy, compact storage.

Bundling - Parflex offers the ability to bundle hose and tubing in a variety of combinations.

Custom Printed Lines - Custom printed lines build brand identity and differentiate products for end users. Simple ink jetting provides a cost effective way to provide crisp clean text, or in some cases, logos.

Colors - Parflex thermoplastic hoses can be manufactured in almost any conceivable color. Colors can offer brand identity, color coding and traceability.

Hybrid Hoses

Patented Manufacturing Process - Robust design and materials minimize in-service problems and maximize service life.

Elastomeric Tube - Provides a clean tube excellent for fluid/chemical compatibility and minimizes the need for expensive cleaning of hose assemblies.

Wire Braided Reinforcement - Wire braids increase pressure ratings, create tight bend radii – excellent cut through resistance.

Synthetic Rubber Cover - Hybrid hoses have a smooth cover that looks like traditional hydraulic hose. Additionally, these hoses complement the look of OEM equipment.

Smaller OD - Compact designs allow tighter bend radius characteristics and work well in small enveloped areas.

Long Lengths - Long length hybrid hoses reduce the number of short unusable hose lengths and thereby save money in the long run.

2-Braid Construction - The 2-braid hybrid hose construction takes the place of traditional 4-spiral wire hose and offers a slimmer profile, lighter weight, and longer lengths.

Widely Accepted - Proven performance over many years.

PTFE Hose & Fittings

Thermoplastic Tubing

Coiled Air Hose, Fittings & Accessories

Truck (Fleet) Products

Tooling & Equipment

Hose Accessories

Technical & Design Information

Approvals & Guides

Alphanumeric Index



How To Select A Hose (STAMPED)

Size	The appropriate inside and outside diameters and length of the hose should be determined
Temperature	The maximum temperature of the material being conveyed
Application	External conditions including abrasion, climate, heat, flexing, crushing, kinking, and degrees of bending
Media	The composition of the substance being conveyed and chemical compatibility with the hose inner core and, if applicable, the outer jacket
Pressure	The maximum pressure of the system, including pressure spikes
Ends	The appropriate end connection and attachment method for the application
Delivery	Testing, quality, packaging, and delivery requirements

Hydraulic & Pneumatic Hose Selection

Hose	General Description	SAE Perf. or Equiv.	Core Tube	Reinforcement	Cover	Page
B9	General Purpose Fuel Transfer	N/A	U	Fiber	U	9
D6	Constant Pressure Hybrid	100R17	P	Wire Braid	R	9
H6	Constant Pressure	100R17	P	Wire Braid	P	10
HFS	General Hydraulic Hybrid	100R1	P	Wire Braid	R	11
HFS2	General Hydraulic Hybrid	100R2/100R16	P	Wire Braid	R	11
HTB	Compact High Pressure Hydraulic Hybrid	N/A	P	Wire Braid	R	12
M8	General Hydraulic Hybrid	100R12	P	Wire Braid	R	12
R6	Constant Pressure	100R17	P	Wire Braid	Fiber	13
560	General Hydraulic	100R1	P	Wire Braid	U	14
563	General Hydraulic	100R17	P	Wire Braid	U	14
590	General Hydraulic	100R2/100R16	P	Wire Braid	U	15
593	General Hydraulic	100R17	P	Wire Braid	U	15
510A	Air Conditioning	100R7	N	Fiber	U	16
510C	General Hydraulic	100R7	P	Fiber	U	17
515H	Compact/Lightweight	N/A	P	Fiber	U	17
518C	Non-conductive Hydraulic	100R7	P	Fiber	U	18
520N	General Hydraulic	100R8	N	Fiber	U	19
528N	Non-conductive Hydraulic	100R8	N	Fiber	U	19
53DM	Low Temperature Constant Pressure	100R18	P	Fiber	P	20
53LT	Low Temperature Constant Pressure	100R18	P	Fiber	P	20
538LT	Non-conductive Low Temperature Constant Pressure	100R18	P	Fiber	P	21
540N	General Hydraulic	100R7	N	Fiber	U	22
55LT	Low Temperature	100R7	P	Fiber	P	23
573X	Fast Response	N/A	N	Fiber	U	23
575X	Fast Response	N/A	N	Fiber	U	24
580N/H580N	High Pressure Hose	100R8	N	Fiber	U	24
588N	High Pressure, Non-conductive Hose	100R8	N	Fiber	U	25
83FR	General Purpose Air & Water, Flame Resistant	N/A	U	Fiber	U	26

Specialty Hose	General Description	SAE Perf. or Equiv.	Core Tube	Reinforcement	Cover	Page
HJK	Jackline Hybrid	N/A	P	Wire Braid	R	26
53GW	Grease Whip	N/A	P	Fiber	U	27
HLB	Lubrication Line	N/A	P	Fiber	U	27
HPS	Paint Spray	N/A	N	Fiber	U	28
MSH	Marine Steering	N/A	N	Fiber	U	28
MTH	DOT Marine Trailer Hose	N/A	N	Fiber	U	29
PTH	Marine Power Tilt	N/A	N	Fiber/Wire Braid	U	29
S4	Water Jetting/Lateral Cleaning	N/A	P	Fiber	U	30
S5	Water Jetting/Lateral Cleaning	N/A	P	Fiber	U	30
S6	Sewer Cleaning	N/A	P	Fiber	U	31
S9	Sewer Cleaning	N/A	P	Fiber	U	31
3CNG	Compressed Natural Gas	N/A	N	Fiber	U	32
4CNG	Compressed Natural Gas	N/A	N	Fiber	U	32
5CNG	Compressed Natural Gas	N/A	N	Fiber	U	32
526BA	Breathing Air Refill	N/A	N	Fiber	U	33
540P	Specialty Water	N/A	PE	Fiber	U	33
56DH/568DH	Diagnostic	N/A	N	Fiber	U	34
1035A	Power Cleaning	N/A	PFX	Fiber	U	35
1035HT	Power Cleaning	N/A	PFX	Fiber	U	35

N = Nylon P = Polyester PE = Polyethylene PFX = Proprietary Material PVC = Polyvinyl Chloride R = Rubber U = Urethane

Use this page to quickly locate hoses based upon SAE/ DIN specifications, equivalents or specialty categories listed. Use the Parflex Quick Guide on the opposing page when general hose size and pressure requirement are known. Locate the size and pressure required, determine applicable hoses in the left column, and use this page to locate additional product information within this section.

Hydraulic & Pneumatic Hose & Fit.

PTFE Hose & Fittings

Thermoplastic Tubing

Coiled Air Hose, Fittings & Accessories

Truck (Fleet) Products

Tooling & Equipment

Hose Accessories

Technical & Design Information

Approvals & Guides

Alphanumeric Index



Hydraulic & Pneumatic Hose PSI (MPa)

Fractional Size	1/8	3/16	1/4	5/16	3/8	1/2	5/8	3/4	1
Dash Size	-2	-3	-4	-5	-6	-8	-10	-12	-16
B9		250(1.7)	250(1.7)	250(1.7)	250(1.7)	250(1.7)	250(1.7)		
D6			3000(20.7)	3000(20.7)	3000(20.7)	3000(20.7)	3000(20.7)	3000(20.7)	3000(20.7)
H6			3000(20.7)	3000(20.7)	3000(20.7)	3000(20.7)	3000(20.7)	3000(20.7)	
HFS			3000(20.7)	3000(20.7)	2500(17.3)	2500(17.3)		1500(10.4)	1250(8.6)
HFS2			5000(34.5)		4000(27.6)	3500(24.2)	2750(19.0)	2250(15.5)	2000(13.8)
HTB			7000(48.3)		5500(38.0)	5000(34.5)	4000(27.6)	4000(27.6)	3500(24.2)
M8					4000(27.6)	4000(27.6)	4000(27.6)		
R6			3000(20.7)		3000(20.7)	3000(20.7)	3000(20.7)	3000(20.7)	3000(20.7)
560		3500(24.2)	3250(22.4)	3000(20.7)	2750(19.0)	2500(17.3)	2000(13.8)	1750(12.1)	
563			3000(20.7)		3000(20.7)	3000(20.7)			
590		5000(34.5)	5000(34.5)		4000(27.6)	3500(24.2)	3000(20.7)	2250(15.5)	2000(13.8)
593								3000(20.7)	3250(22.4)
510A	2500(17.3)	3000(20.7)	2750(19.0)	2500(17.3)	2250(15.5)	2000(13.8)		1250(8.6)	1000(6.9)
510C	2500(17.3)	3250(22.4)	3000(20.7)	2500(17.3)	2250(15.5)	2250(15.5)	1500(10.4)	1250(8.6)	1000(6.9)
515H		2175(15.0)	2000(13.8)	1750(12.1)	1500(10.4)	1500(10.4)			
518C	2500(17.3)	3250(22.4)	3000(20.7)	2500(17.3)	2250(15.5)	2250(15.5)	1500(10.4)	1250(8.6)	1000(6.9)
520N		5000(34.5)	5000(34.5)	4500(31.05)	4000(27.6)	3500(24.2)			
528N		5000(34.5)	5000(34.5)	4500(31.05)	4000(27.6)	3500(24.2)			
53DM		3000(20.7)	3000(20.7)	3000(20.7)	3000(20.7)	3000(20.7)	3000(20.7)		
53LT		3000(20.7)	3000(20.7)	3000(20.7)	3000(20.7)	3000(20.7)	3000(20.7)	3000(20.7)	
538LT		3000(20.7)	3000(20.7)	3000(20.7)	3000(20.7)	3000(20.7)	3000(20.7)	3000(20.7)	
540N	2500(17.3)	3000(20.7)	2750(19.0)	2500(17.3)	2250(15.5)	2000(13.8)		1250(8.6)	
55LT	3000(20.7)	3250(22.4)	3000(20.7)	2500(17.3)	2250(15.5)	2000(13.8)		1250(8.6)	
573X		3000(20.7)							3000(20.7)
575X		5000(34.5)	5000(34.5)		5000(34.5)	5000(34.5)		5000(34.5)	5000(34.5)
580N			5000(34.5)		4000(27.6)	3500(24.2)	2750(19.0)	2250(15.5)	2000(13.8)
H580N									3000(20.7)
588N			5000(34.5)		4000(27.6)	3500(24.2)	2750(19.0)	2250(15.5)	2000(13.8)
83FR			300	1500(10.4)	300	300		300	

Specialty Hoses

Fractional Size	3/32	1/8	3/16	1/4	5/16	3/8	1/2	5/8	3/4	1	1-1/4	1-1/2
Dash Size	-1.5	-2	-3	-4	-5	-6	-8	-10	-12	-16	-20	-24
HJK				10,000(69)								
53GW		3000(20.7)	3000(20.7)									
HLB		3000(20.7)	3000(20.7)									
HPS				3000(20.7)								
MSH					1000(6.9)	1000(6.9)						
MTH				1000(6.9)								
PTH			3000(20.7)									
S4							4000(27.6)	4000(27.6)				
S5							4000(27.6)	4000(27.6)				
S6									2500(17.3)	2500(17.3)	2500(17.3)	2500(17.3)
S9									3000(20.7)	3000(20.7)		
3CNG				3600(24.8)		3600(24.8)						
4CNG						4000(27.6)						
5CNG			5000(34.5)	5000(34.5)		5000(34.5)	5000(34.5)		5000(34.5)			
526BA			6000(41.4)	6000(41.4)		6000(41.4)						
540P				2750(19.0)		2250(15.5)	2000(13.8)	1500(10.4)	1250(8.6)	5000(34.5)		
56DH/568DH	6000(41.1)	6000(41.1)										
1035A				1500(10.4)		1200(8.3)						
1035HT			2000(13.8)	1750(12.1)		1500(10.4)						

Hydraulic & Pneumatic Hose & Fit.

PTFE Hose & Fittings

Thermoplastic Tubing

Coiled Air Hose, Fittings & Accessories

Truck (Fleet) Products

Tooling & Equipment

Hose Accessories

Technical & Design Information

Approvals & Guides

Alphanumeric Index



Hose Assembly Nomenclature



F	540N	06	39	08	08	08	C	30	N/A
Prefix	Hose Type	Fitting 1st End Configuration	Fitting 2nd End Configuration	Size 1st End	Size 2nd End	Hose End Dash Size	Fitting Matl	Length	Displacement Angle
F= Crimp R= Field Attachable Ftng A= 54 Series Factory							Blank= Steel C= Stain- less B= Brass	Overall Length always expressed in inches If elbow fittings are used, overall length is measured from the centerline of the seat	Specified only if two elbow fittings are used. Starting with either end as the far end, measure the angle clockwise to describe the displacement of the near end.

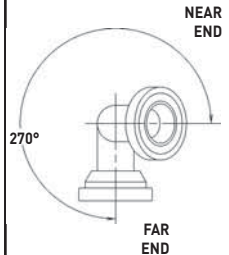

This assembly example reflects a 1/2" ID 540N hose with an SAE 1/2" female JIC 37° straight fitting on the first end and an SAE 1/2" 90° female JIC 37° elbow fitting on the other. The fittings are crimped (permanently attached) and stainless steel. The overall length is 30".

The first fitting configuration callout is 10655-8-8
The second fitting configuration callout is 13955-8-8

Special Notes

Seal-Lok™ fittings are always measured to the sealing surface

The callout for this completed hose assembly would be: **F540N0639080808C-30"**

Hose Fittings Nomenclature

1	03	55	8	6	N/A
Type	End Configuration Code	Series of Fitting	End Size	Hose Size	Material
1=Crimp 2=Field Attachable					Blank=Steel B=All Brass C=Stainless Steel S= All Carbon Steel-Used only with PTFE fittings

This example describes a permanent crimp 1/2" Male SAE JIC 37° hose end with a 3/8" hose end-this commonly referred to as a "jump size". This fitting is constructed from carbon steel since the designated material is blank.

The callout is: **10355-8-6**

Other end configuration codes found on page 40 .

B9 - General Purpose Fuel Transfer Hose

250 PSI Constant Pressure



Part Number	I. D.		Max. O. D.		Max. Working Pressure		Min. Bend Radius		Weight		Crimp Fitting		Field Attachable Fitting	
	#	inch	mm	inch	mm	wpsi	MPa	inch	mm	lbs/ft	kg/m	series	pg	re
B903	3/16	5	0.38	10	250	1.72	1	25.4	0.04	0.059	55	53-69		
B904	1/4	6	0.45	11	250	1.72	1-1/2	38.1	0.05	0.074			82	*
B905	5/16	8	0.54	14	250	1.72	2	50.8	0.08	0.118	55	53-69		
B906	3/8	10	0.63	16	250	1.72	3	76.2	0.09	0.133			82	*
B908	1/2	13	0.77	20	250	1.72	3	76.2	0.13	0.192			82	*
B910	5/8	16	0.92	23	250	1.72	4	101.6	0.2	0.296			82	*

Min. Burst Pressure is 4x Max. Working Pressure

*Available from Hose Products Division N/A = Not Available

Tube: Specially formulated fuel resistant Urethane
Reinforcement: Fiber
Cover: Same as Core
Cover Color: Red
Temperature Range: -40°F to +200°F
 -40°C to +93°C
Vacuum Rating: 28 inch Hg

(Delta) Working Length @ Rated WPSI: ±2%
Note: 82 series push-on coupling is not recommended where pressure and/or temperature exceeds +100F and 100 PSI.

Applications/Markets:
 Low pressure transmission of oil, air, water and coolants where operation pressures do not exceed 250 PSI.

Special Features:
 Highly flexible

D6 - Hybrid Hose

Exceeds SAE 100R17

3000 PSI Constant Pressure

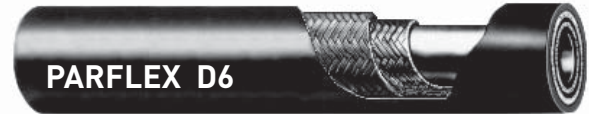

Part Number	I. D.		Max. O. D.		Max. Working Pressure		Min. Bend Radius		Weight		Crimp Fitting		80C Crimp Die
	#	inch	mm	inch	mm	wpsi	MPa	inch	mm	lbs/ft	kg/m	series	pg
D604	1/4	6	.50	13	3000	20.7	2.0	51	.12	.18	HY*	112-128	P0580
D606	3/8	10	.66	17	3000	20.7	2.5	64	.23	.34	HY*	112-128	P0740
D608	1/2	13	.80	20	3000	20.7	3.5	89	.29	.43	HY*	112-128	P0870
D610**	5/8	16	1.00	25	3000	20.7	4.0	102	.47	.70	HY*	112-128	P1405
D612**	3/4	19	1.18	30	3000	20.7	4.8	122	.73	1.08	HY*	112-128	P1220
D616**	1	25	1.48	38	3000	20.7	6.0	152	1.01	1.49	HY*	112-128	P1525

Min. Burst Pressure is 4x Max. Working Pressure

*Available from Hose Products Division

Tube: Polyester
Reinforcement: 1 or 2** braids of high tensile steel wire
Cover: Smooth synthetic rubber-MSHA approved
Cover Color: Black
Temperature Range: -40°F to +250°F*
 -40°C to +121°C*

Applications/Markets:
 Industrial medium pressure hydraulic applications where a maximum 3000 PSI working pressure is required.

Special Features:
 Ideally suited for inventory consolidations to cover all SAE 100R1 pressure and many SAE 100R2 pressure requirements.

*Limited to +135°F (+57°C) for synthetic hydraulic fluids and water-based fluids

Vacuum Rating: 28 inch Hg

(Delta) Working Length @ Rated WPSI: +2% / -4%

Note: The above hose(s) are not intended for use in static discharge applications; i.e., airless paint spray.



Hydraulic & Pneumatic Hose & Fit.
 PTFE Hose & Fittings
 Thermoplastic Tubing
 Coiled Air Hose, Fittings & Accessories
 Truck (Fleet) Products
 Tooling & Equipment
 Hose Accessories
 Technical & Design Information
 Approvals & Guides
 Alphanumeric Index

H6 - Hydraulic Hose

SAE 100R17 Performance

3000 PSI Constant Pressure



Part Number	I. D.		Max. O. D.		Max. Working Pressure		Min. Bend Radius		Weight		Crimp Fitting		80C Crimp Die
	#												
hose	inch	mm	inch	mm	wpsi	MPa	inch	mm	lbs/ft	kg/m	series	pg	crimp die
H604	1/4	6	.48	12	3000	20.7	2.0	51	.12	.18	HY*	112-128	P0550
H605	5/16	8	.55	14	3000	20.7	2.3	58.4	.14	.21	HY*	112-128	P0635
H606	3/8	10	.64	16	3000	20.7	2.5	64	.19	.28	HY*	112-128	P0705
H608	1/2	13	.77	20	3000	20.7	3.5	89	.29	.43	HY*	112-128	P0845
H610**	5/8	16	.99	25	3000	20.7	4.0	102	.47	.70	HY*	112-128	P1045
H612**	3/4	19	1.16	30	3000	20.7	4.8	122	.69	1.03	HY*	112-128	P1195

Min. Burst Pressure is 4x Max. Working Pressure

*Available from Hose Products Division

- Tube:** Polyester
- Reinforcement:** 1 or 2** braid of high tensile steel wire
- Cover:** Polyester
- Cover Color:** Black
- Temperature Range:** -70°F to +250°F* (H604 thru H608)
-56°C to +120°C*
-50°F to +250°F* (H610 thru H612)
-45°C to +120°C*
- Vacuum Rating:** 28 inch Hg

[Delta] Working Length @ Rated WPSI: +2% / -4%

Applications/Markets:

Industrial medium pressure hydraulic applications where a maximum 3000 PSI working pressure is required
Ideally suited for inventory consolidations to cover all SAE 100R1 pressure and many SAE 100R2 pressure and abrasion requirements

Special Features:

Excellent abrasion resistance over rough surfaces

* Limited to +135°F (+57°C) for synthetic hydraulic fluids and water-based fluids

Note: The above hose(s) are not intended for use in static discharge applications; i.e., airless paint spray.



HFS - Firescreen® Hybrid Hose

Exceeds SAE 100R1AT

1250-3000 PSI



Part Number	I. D.		Max. O. D.		Max. Working Pressure		Min. Bend Radius		Weight		Crimp Fitting		80C Crimp Die	Field Attachable Fitting	
	#	inch	mm	inch	mm	wpsi	MPa	inch	mm	lbs/ft	kg/m	series	pg	crimp die	re
HFS04	1/4	6	.50	13	3000	20.7	2.0	51	.12	.18	HY*	112-128	P0580	BA	105-107
HFS05	5/16	8	.58	15	3000	20.7	2.3	58.4	.17	.25	HY*	112-128	P0665	N/A	
HFS06	3/8	10	.66	17	2500	17.24	2.5	64	.19	.28	HY*	112-128	P0740	BA	105-107
HFS08	1/2	13	.77	20	2500	17.24	3.5	89	.25	.37	HY*	112-128	P0845	BA	105-107
HFS12	3/4	19	1.05	27	1500	10.34	5.0	127	.37	.55	HY*	112-128	P1130	N/A	
HFS16	1	25	1.35	34	1250	8.6	10.0	254	.53	.79	HY*	112-128	P1395	N/A	

Min. Burst Pressure is 4x Max. Working Pressure

Tube: Polyester
Reinforcement: One braid of high tensile steel wire
Cover: Smooth synthetic rubber-MSHA approved
Cover Color: Black
Temperature Range: -40°F to +250°F*
 -40°C to +121°C*

*Limited to +135°F (+57°C) for synthetic hydraulic fluids and water-based fluids

Vacuum Rating: 28 inch Hg

(Delta) Working Length @ Rated WPSI: +2%/-4%

*Available from Hose Products Division N/A = Not Available

Applications/Markets:
 High temperature (to +250°F), medium pressure hydraulic lines on mobile equipment, machine tools, farm machinery, and other industrial applications

Special Features:
 Pressures and temperatures above comparable SAE 100R1 requirements
 Compact design

HFS2 - Firescreen II® Hybrid Hose

SAE 100R2/100R16 Performance

2000-5000 PSI



Part Number	I. D.		Max. O. D.		Max. Working Pressure		Min. Bend Radius		Weight		Crimp Fitting		80C Crimp Die	Field Attachable Fitting	
	#	inch	mm	inch	mm	wpsi	MPa	inch	mm	lbs/ft	kg/m	series	pg	crimp die	re
HFS204**	1/4	6	.56	14	5000	34.5	2.0	50.8	.21	.31	HY*	112-128	P0625	BA	105-107
HFS206	3/8	10	.66	17	4000	27.6	2.5	63.5	.23	.34	HY*	112-128	P0740	BA	105-107
HFS208	1/2	13	.80	20	3500	24.1	3.5	88.9	.29	.43	HY*	112-128	P0870	BA	105-107
HFS210	5/8	16	.95	24	2750	19.0	4.0	101.6	.38	.57	HY*	112-128	P1015	N/A	
HFS212	3/4	19	1.08	27	2250	15.5	4.8	121.9	.45	.67	HY*	112-128	P1150	BA	105-107
HFS216**	1	25	1.43	36	2000	13.8	6.0	152.4	.80	1.19	HY*	112-128	P1450	BA	105-107

Min. Burst Pressure is 4x Max. Working Pressure

Tube: Polyester
Reinforcement: 1 or 2** braids of high tensile steel wire
Cover: Smooth synthetic rubber-MSHA approved
Cover Color: Black
Temperature Range: -40°F to +212°F*
 -40°C to +100°C*

*Limited to +135°F (+57°C) for synthetic hydraulic fluids and water-based fluids

Vacuum Rating: 28 inch Hg

(Delta) Working Length @ Rated WPSI: +2% / -4%

*Available from Hose Products Division N/A = Not Available

Applications/Markets:
 High pressure (similar to SAE 100R2) hydraulic lines on off-road construction equipment, machine tools, mining equipment, and other industrial applications

Special Features:
 Light Weight
 Compact

Note: The above hose(s) are not intended for use in static discharge applications; i.e., airless paint spray.



Hydraulic & Pneumatic Hose & Fit.
 PTFE Hose & Fittings
 Thermoplastic Tubing
 Coiled Air Hose, Fittings & Accessories
 Truck (Fleet) Products
 Tooling & Equipment
 Hose Accessories
 Technical & Design Information
 Approvals & Guides
 Alphanumeric Index

HTB - Eliminator[®] Hybrid Hose

4-Spiral Wire Performance

3500-7000 PSI

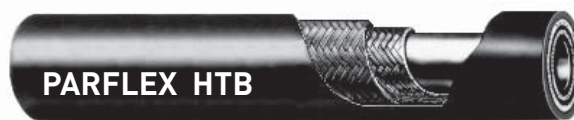

Part Number	I. D.		Max. O. D.		Max. Working Pressure		Min. Bend Radius		Weight		Crimp Fitting	80C Crimp Die
	#											
hose	inch	mm	inch	mm	wpsi	MPa	inch	mm	lbs/ft	kg/m	series	crimp die
HTB04	1/4	6	.60	15	7000	48.3	4.0	102	.27	.40	HY	† see crimp source
HTB06	3/8	10	.74	19	5500	37.9	6.0	152	.37	.55	43*	A06
HTB08	1/2	13	.88	22	5000	34.5	7.0	178	.46	.69	43*	A08
HTB10	5/8	16	1.01	26	4000	27.6	8.0	203	.52	.77	43*	A10
HTB12	3/4	20	1.18	30	4000	27.6	9.5	241	.73	1.1	43*	A12
HTB16	1	25	1.48	38	3500	24.0	12.0	305	1.01	1.5	43*	A16

Min. Burst Pressure is 4x Max. Working Pressure

Tube: Polyester
Reinforcement: Two braids of high tensile steel wire
Cover: Smooth synthetic rubber-MSHA approved
Cover Color: Black
Temperature Range: -40°F to +212°F
 -40°C to +100°C

(Limited to +135°F (+57°C) for synthetic hydraulic fluids and water-based fluids)

Vacuum Rating: 28 inch Hg

(Delta) Working Length @ Rated WPSI: +2% / -4%

Applications/Markets:

High pressure hydraulic applications where spiral wire reinforced hose might normally be used.

Special Features:

Eliminator offers 4-spiral wire hose performance in a high tensile two-wire braid construction. Provides excellent flexibility, light weight, consistent long length patterns, and excellent value versus comparable SAE 100R9 and SAE 100R12 spiral reinforced hoses.

***HTB HOSE REQUIRES "A" SERIES PARKER DIES AND BLACK DIE RING**

Series 43 fittings, dies and black die ring available from Parker Hose Products Division

† **Note:** HTB04 requires Skiving Hose

M8 - E-Z FLEX[®] Hybrid Hose

SAE 100R12 Performance

4000 PSI Constant Pressure



Part Number	I. D.		Max. O. D.		Max. Working Pressure		Min. Bend Radius		Weight		Crimp Fitting	80C Crimp Die
	#											
hose	inch	mm	inch	mm	wpsi	MPa	inch	mm	lbs/ft	kg/m	series	crimp die
M806	3/8	10	.74	19	4000	27.6	2.5	64	.37	.55	43*	M0850
M808	1/2	13	.88	22	4000	27.6	3.5	89	.46	.69	43*	M1010
M810	5/8	16	1.05	27	4000	27.6	4.0	102	.63	.94	43*	M1170

Min. Burst Pressure is 4x Max. Working Pressure

Tube: Polyester
Reinforcement: Two braids of high tensile steel wire
Cover: Smooth synthetic rubber-MSHA approved
Cover Color: Black
Temperature Range: -40°F to +250°F
 -40°C to +121°C

(Limited to +135°F (+57°C) for synthetic hydraulic fluids and water-based fluids)

Vacuum Rating: 28 inch Hg

(Delta) Working Length @ Rated WPSI: +2% / -4%

Applications/Markets:

High pressure hydraulic applications where spiral wire reinforced hose might normally be used

Special Features:

4-spiral wire pressures with two wire construction. Provides excellent flexibility, consistent long length patterns, and excellent value versus comparable SAE 100R9 and SAE 100R12 4-spiral wire reinforced hoses

***Series 43 fittings available from Parker Hose Products Division Silver Die Ring Required & Available from Parker Parflex**

Note: The above hose(s) are not intended for use in static discharge applications; i.e., airless paint spray.

R6 - Abrasion King® Hose

SAE 100R17 Performance

3000 PSI Constant Pressure



Part Number	I. D.		Max. O. D.		Max. Working Pressure		Min. Bend Radius		Weight		Crimp Fitting		80C Crimp Die
	#												
hose	inch	mm	inch	mm	wpsi	MPa	inch	mm	lbs/ft	kg/m	series	pg	crimp die
R604	1/4	6	.51	13	3000	20.7	2.0	51	.11	.16	HY*	112-128	P0570
R606	3/8	10	.69	17	3000	20.7	2.5	64	.20	.30	HY*	112-128	P0740
R608	1/2	13	.82	21	3000	20.7	3.5	89	.27	.40	HY*	112-128	P0870
R610**	5/8	16	1.07	27	3000	20.7	4.0	102	.51	.76	HY*	112-128	P1100
R612**	3/4	19	1.23	31	3000	20.7	4.8	122	.71	1.1	HY*	112-128	P1245
R616**	1	25	1.53	39	3000	20.7	6.0	152	1.00	1.49	43*		M1600

Min. Burst Pressure is 4x Max. Working Pressure

Tube: Polyester

Reinforcement: 1 or 2** braids of high tensile steel wire

Cover: Abrasion resistant nylon fabric

Cover Color: Black with blue plait

Temperature Range: -50°F to +250°F
-46°C to +121°C

(Limited to +135°F (+57°C) for synthetic hydraulic fluids and water-based fluids)

Vacuum Rating: 28 inch Hg

(Delta) Working Length @ Rated WPSI: ±3%

Applications/Markets:

Industrial medium pressure hydraulic applications where a maximum 3000 PSI working pressure required

Covers all SAE 100R1 pressure and many SAE 100R2 pressure and abrasion requirements

Special Features:

Excellent abrasion resistance, especially over irregular surfaces or hose-to-hose, and the blue plait provides easy identification

Old part numbers were R612A/ R616A—no change in performance or product design.

*Series HY & 43 fittings available from Parker Hose Products Division

Note: The above hose is not intended for use in static discharge applications; i.e., airless paint spray.

560 - General Hydraulic Hose Meets or Exceeds SAE 100R1 1750 to 3500 PSI



Part Number	I. D.		Max. O. D.		Max. Working Pressure		Min. Bend Radius		Weight		Crimp Fitting		80C Crimp Die
	#												
hose	inch	mm	inch	mm	wpsi	MPa	inch	mm	lbs/ft	kg/m	series	pg	crimp die
560-3	3/16	5	0.42	11	3500	24.13	3/4	19	.071	.106	55	53-77	P03
560-4	1/4	6	0.51	13	3250	22.41	1-3/4	44	.098	.146	55	53-77	P04
560-5	5/16	8	0.57	14	3000	20.68	2	51	.124	.185	55	53-77	P05
560-6	3/8	10	0.64	16	2750	18.96	2-1/4	57	.150	.224	55	53-77	P06
560-8	1/2	13	0.80	20	2500	17.24	3-1/4	83	.202	.301	55	53-77	P08J
560-10	5/8	16	0.93	24	2000	13.79	6	152	.298	.444	55	53-77	P10
560-12	3/4	19	1.12	28	1750	12.07	7	178	.406	.605	58	78-102	P12H

Min. Burst Pressure is 4x Max. Working Pressure

- Tube:** Polyester
- Reinforcement:** Wire braid
- Cover:** Urethane
- Cover Color:** Black non perforated
- Temperature Range:** -40°F to +250°F*
-40°C to +121°C*

*Limited to +135°F (+57°C) for synthetic hydraulic fluids and water-based fluids

Vacuum Rating: 28 inch Hg

(Delta) Working Length @ Rated WPSI: ±2% Max

Applications/Markets:

Hydraulic circuits and systems wherever 100R1 hose is specified. Most synthetic hydraulic fluids, water and wide range of chemicals, industrial equipment, machine tools

Special Features:

Twin or multi-line available. Lighter and smaller than 100R1 with longer lengths
Fast response hose

563 - General Hydraulic Hose 3000 PSI Constant Pressure



Part Number	I. D.		Max. O. D.		Max. Working Pressure		Min. Bend Radius		Weight		Crimp Fitting		80C Crimp Die
	#												
hose	inch	mm	inch	mm	wpsi	MPa	inch	mm	lbs/ft	kg/m	series	pg	crimp die
563-4	1/4	6	0.49	12	3000	20.68	2	50.8	0.121	0.179	HY*	112-128	P04J
563-6	3/8	10	0.65	17	3000	20.68	2-1/2	63.5	0.19	0.281	HY*	112-128	P0715
563-8	1/2	13	0.78	20	3000	20.68	3-1/2	88.9	0.29	0.429	HY*	112-128	P0845

Min. Burst Pressure is 4x Max. Working Pressure

- Tube:** Polyester
- Reinforcement:** High Tensile Steel Wire Braid
- Cover:** Urethane
- Cover Color:** Black Non Perforated
- Temperature Range:** -40°F to +250°F (212F for size -8)
-40°C to +121°C (100C for size -8)

(Limited to +135°F (+57°C) for synthetic hydraulic fluids and water-based fluids)

Vacuum Rating: 28 inch Hg

(Delta) Working Length @ Rated WPSI: ±2%

Applications/Markets:

Industrial medium pressure hydraulic applications where a maximum 3000 PSI wp is required

Special Features:

Covers all SAE 100R1 and many SAE 100R2 pressure requirements

*Series HY fittings available from Parker Hose Products Division

Note: The above hose(s) are not intended for use in static discharge applications; i.e., airless paint spray.



590 - General Hydraulic Hose Meets or Exceeds SAE 100R2/100R16 2000 to 5000 PSI



Part Number	I. D.		Max. O. D.		Max. Working Pressure		Min. Bend Radius		Weight		Crimp Fitting		80C Crimp Die
	#												
hose	inch	mm	inch	mm	wpsi	MPa	inch	mm	lbs/ft	kg/m	series	pg	crimp die
590-3	3/16	5	0.43	11	5000	34.47	1-1/2	38	.102	.152	55	53-77	P03
590-4	1/4	6	0.51	13	5000	34.47	1-3/4	44	.138	.206	55	53-77	P04
590-6	3/8	10	0.64	16	4000	27.58	2-1/4	57	.194	.289	55	53-77	P06
590-8	1/2	13	0.80	20	3500	24.13	3-1/4	82	.250	.373	55	53-77	P08J
590-10	5/8	16	0.97	25	3000	20.68	6	152	.386	.575	58	78-102	P10H
590-12	3/4	19	1.11	28	2500	17.24	7	178	.446	.665	58	78-102	P12H
590-16	1	25	1.42	36	2000	13.79	8	203	.592	.882	58	78-102	P16J

Min. Burst Pressure is 4x Max. Working Pressure

Tube: Polyester
Reinforcement: Aramid fiber, high tensile wire braid
Cover: Urethane
Cover Color: Black Non Perforated
Temperature Range: -40°F to +250°F
 -40°C to +121°C

(Limited to +135°F [+57°C] for synthetic hydraulic fluids and water-based fluids)

Vacuum Rating: 28 inch Hg

(Delta) Working Length @ Rated WPSI: ±2% Max

Applications/Markets:

Construction equipment, machine tools, hydrostatic transmissions, refuse vehicles and agriculture equipment.

Special Features:

Two wire strength, one wire construction, improved bend radius results
 Twin and multi-line available.

593 - General Hydraulic Hose Meets or Exceeds SAE 100R2 3000 to 3250 PSI



Part Number	I. D.		Max. O. D.		Max. Working Pressure		Min. Bend Radius		Weight		Crimp Fitting		Crimp Die
	#												
hose	inch	mm	inch	mm	wpsi	MPa	inch	mm	lbs/ft	kg/m	series	pg	crimp die
593-12	3/4	20	1.12	29	3000	20.68	7	177.8	.470	.700	LV	41	80C-P12L
593-16	1	25	1.45	37	3250	22.41	8	203.2	.687	1.024	LV	41	83C-P16L

Min. Burst Pressure is 4x Max. Working Pressure

Tube: 16 Nylon- 12 Polyester
Reinforcement: Wire braid
Cover: Urethane
Cover Color: Black (non perforated)
Temperature Range: -40°F to +212°F
 -40°C to +100°C

Limited to +135°F [+57°C] for synthetic hydraulic fluids (size-12 only) and water-based fluids.

Vacuum Rating: 28 inch Hg

(Delta) Working Length @ Rated WPSI: ±2% Max

Applications/Markets:

General hydraulic service

Special Features:

Works with synthetic hydraulic fluids, water and a range of chemicals
 Two wire strength with one braid flexibility

Note: The above hose(s) are not intended for use in static discharge applications; i.e., airless paint spray.

510A - Refrigerant Hose

Meets or Exceeds SAE100R7

1000 to 3000 PSI



PTFE Hose & Fittings

Thermoplastic Tubing

Coiled Air Hose, Fittings & Accessories

Truck (Fleet) Products

Tooling & Equipment

Hose Accessories

Technical & Design Information

Approvals & Guides

Alphanumeric Index

Part Number	I. D.		Max. O. D.		Max. Working Pressure		Min. Bend Radius		Weight		Crimp Fitting		80C Crimp Die	Field Attachable Fitting	
	#														
hose	inch	mm	inch	mm	wpsi	MPa	inch	mm	lbs/ft	kg/m	series	pg	crimp die	re	pg
510A-2 (+)	1/8	3	0.34	9	2500	17.24	1/2	13	.034	.051	57	53-77	P02H	N/A	
510A-3	3/16	5	0.43	11	3000	20.68	2	51	.049	.077	55	53-77	P03	51	44-52
510A-4	1/4	6	0.47	12	2750	18.96	2-1/2	64	.052	.077	55	53-77	P04J	51	44-52
510A-5	5/16	10	0.57	20	2500	17.24	3	76	.077	.115	55	53-77	P05	51	44-52
510A-6	3/8	13	0.63	16	2250	15.51	4	102	.084	.125	55	53-77	P06	51	44-52
510A-8	1/2	16	0.81	21	2000	13.79	5-1/2	140	.131	.195	55	53-77	P08	51	44-52
510A-12	3/4	19	1.10	28	1250	8.62	7-1/2	191	.192	.286	N/A		N/A	51	44-52
510A-16 (+)	1	25	1.37	40	1000	6.90	10	254	.275	.410	N/A		N/A	51	44-52

Min. Burst Pressure is 4x Max. Working Pressure

N/A = Not Available

Tube: Proprietary nylon blend

Reinforcement: Fiber

Cover: Urethane

Cover Color: Black Perforated

Temperature Range: -40°F to +212°F

-40°C to +100°C

Vacuum Rating: 28 inch Hg

(Delta) Working Length @ Rated WPSI: ±3% Max.

Applications/Markets:

Medium pressure service for both field attachable and permanent fittings

Refrigerants: R12, R22, R134A and R502.

Special Features:

Excellent impulse life

Compatible with most common hydraulic and refrigeration fluids

*** 51 series field attachable couplings are not intended for use on hose that has previously been in service.**

Note: The above hose(s) are not intended for use in static discharge applications; i.e., airless paint spray.



510C - General Hydraulic Hose Meets or Exceeds SAE 100R7 1000 to 3000 PSI



Part Number	I. D.		Max. O. D.		Max. Working Pressure		Min. Bend Radius		Weight		Crimp Fitting		80C Crimp Die	Field Attachable Fitting	
	#	inch	mm	inch	mm	wpsi	MPa	inch	mm	lbs/ft	kg/m	series	pg	crimp die	re
510C-2 (+)	1/8	3	0.34	9	2500	17.24	1/2	13	.031	.046	57	53-77	P02H	N/A	
510C-3	3/16	5	0.42	11	3250	22.41	3/4	19	.046	.069	55	53-77	P03	**	
510C-4	1/4	6	0.47	12	3000	20.68	1-1/2	38	.052	.077	55	53-77	P04J	**	
510C-5	5/16	8	0.57	14	2500	17.24	1-3/4	44	.075	.112	55	53-77	P05	51	44-52
510C-6	3/8	10	0.63	16	2250	15.51	2	51	.096	.143	55	53-77	P06	51	44-52
510C-8	1/2	13	0.81	21	2250	15.51	3	76	.148	.221	55	53-77	P08	51	44-52
510C-10	5/8	16	0.98	25	1500	10.34	4	102	.200	.298	58	78-102	P10H	N/A	
510C-12	3/4	19	1.08	27	1250	8.62	6	152	.188	.280	55	53-77	P12	51	44-52
510C-16	1	25	1.32	34	1000	6.90	8	203	.269	.401	55	53-77	P16	51	44-52

Min. Burst Pressure is 4x Max. Working Pressure

N/A = Not Available

Tube: Polyester
Reinforcement: Fiber
Cover: Proprietary Blend (PFX)
Cover Color: Black, perforated
Temperature Range: -40°F to +212°F
 -40°C to +100°C

(Limited to +135°F [+57°C] for synthetic hydraulic fluids and water-based fluids)

Vacuum Rating: 28 inch Hg

(Delta) Working Length @ Rated WPSI: ±2% Max.

Applications/Markets:

Medium pressure service for permanent and field attachable fittings.

Special Features:

Superior abrasion resistance
 ** 3/16" and 1/4" working pressure reduced to 3,000 and 2,750 psi respectively when using field attachable couplings

515H - Compact/Light Weight Hose 1500 to 2175 PSI



Part Number	I. D.		Max. O. D.		Max. Working Pressure		Min. Bend Radius		Weight		Crimp Fitting
	#	inch	mm	inch	mm	wpsi	MPa	inch	mm	lbs/ft	kg/m
515H-3	3/16	5	0.33	8	2175	15.00	3/4	19	.029	.043	54*
515H-4	1/4	6	0.41	10	2000	13.79	1-1/2	38	.035	.052	54*
515H-5	5/16	8	0.49	12	1750	12.07	1-3/4	44	.049	.073	54*
515H-6	3/8	10	0.56	14	1500	10.34	2	51	.052	.077	54*
515H-8	1/2	13	0.71	18	1500	10.34	3	76	.106	.158	54*

Min. Burst Pressure is 4x Max. Working Pressure

(Delta) Working Length @ Rated WPSI: ±2% Max.

Tube: Polyester
Reinforcement: Fiber
Cover: Urethane
Cover Color: Black Perforated
Temperature Range: -40°F to +212°F
 -40°C to +100°C

(Limited to +135°F [+57°C] for synthetic hydraulic fluids and water-based fluids)

Vacuum Rating: 28 inch Hg

Applications/Markets:

Hydraulic and pneumatic systems where a small O.D. hose is necessary. Pilot lines and joystick controls

Special Features:

Lightweight, flexible, special order colors
 Twin or multi-line available

*** 51 series field attachable couplings are not intended for use on hose that has previously been in service.**

***Factory only assemblies**

Note: The above hose(s) are not intended for use in static discharge applications; i.e., airless paint spray.



Hydraulic & Pneumatic Hose & Fit.
 PTFE Hose & Fittings
 Thermoplastic Tubing
 Coiled Air Hose, Fittings & Accessories
 Truck (Fleet) Products
 Tooling & Equipment
 Hose Accessories
 Technical & Design Information
 Approvals & Guides
 Alphanumeric Index

518C - Non-Conductive Hose SAE J517 ANSI A92.2 Meets or Exceeds SAE 100R7 1000 to 3000 PSI



PTFE Hose & Fittings

Thermoplastic Tubing

Coiled Air Hose, Fittings & Accessories

Truck (Fleet) Products

Tooling & Equipment

Hose Accessories

Technical & Design Information

Approvals & Guides

Alphanumeric Index

Part Number	I. D.		Max. O. D.		Max. Working Pressure ANSI A92.2		Max. Working Pressure SAE 100R7		Min. Bend Radius		Weight		Crimp Fitting		80C Crimp Die	Field Attachable Fitting		
	#	inch	mm	inch	mm	wpsi	MPa	wpsi	MPa	inch	mm	lbs/ft	kg/m	series	pg	crimp die	re	pg
518C-2	1/8	3	0.34	9	3000	20.68	2500	17.24	1/2	13	.031	.046	57	53-77	P02H	N/A		
518C-3	3/16	5	0.42	11	3000	20.68	3250	20.68	3/4	19	.046	.069	55	53-77	P03	**		
518C-4	1/4	6	0.47	12	3000	20.68	3000	18.96	1-1/2	38	.052	.077	55	53-77	P04J	**		
518C-5	5/16	8	0.57	14	3000	20.68	2500	17.24	1-3/4	44	.075	.112	55	53-77	P05	51	42-50	
518C-6	3/8	10	0.63	16	3000	20.68	2250	15.51	2	51	.096	.143	55	53-77	P06	51	42-50	
518C-8	1/2	13	0.81	21	3000	20.68	2250	15.51	3	76	.148	.221	55	53-77	P08	51	42-50	
518C-10 (+)	5/8	16	0.98	25	2000	13.8	1500	10.34	4	102	.200	.298	58	78-102	P10H	N/A		
518C-12	3/4	19	1.08	27	1660	11.4	1250	8.62	6	152	.188	.280	55	53-77	P12	51	42-50	
518C-16	1	25	1.32	34	1330	9.2	1000	6.90	8	203	.269	.401	55	53-77	P16	51	42-50	

N/A = Not Available

Tube: Polyester
Reinforcement: Fiber
Cover: Proprietary Blend (PFX)
Cover Color: Orange, non-perforated
Temperature Range: -40°F to +212°F (-40°C to +100°C)
 (Limited to +135°F (+57°C) for synthetic hydraulic fluids and water-based fluids)
Vacuum Rating: N/A
(Delta) Working Length @ Rated WPSI: ±2% Max.

Applications/Markets:
 Medium pressure hydraulic service where both field attachable and permanent hydraulic circuit exposure and contact with high voltage may be encountered

Special Features:
 Twin or multi-line constructions available
 Meets SAE J517 for less than 50 micro-amps leakage under 75,000 volts per ft. Meets or exceeds SAE 100R7 specifications and Ontario Hydro electrical standards
 Complies with ANSI A92.2 for vehicle-mounted aerial devices. High density braid for maximum impulse life without loss of flexibility

Note: Lay lines on this hose will have both ANSI and SAE maximum working pressures listed. ANSI A92.2-1990 "Vehicle Mounted Elevating and Rotating Aerial Devices."

** 3/16" and 1/4" working pressure reduced to 3,000 and 2,750 respectively when using field attachable (51 series) couplings.

Min. Burst Pressure:
 4:1 Design Factor is required if hose failure will result in movement of aerial device.
 3:1 Design Factor is acceptable if hose failure will not result in movement of aerial device.
 SAE requires 4:1 Design Factor.

*** 51 series field attachable couplings are not intended for use on hose that has previously been in service.**

Note: The above hose(s) are not intended for use in static discharge applications; i.e., airless paint spray.
 (+) Non Standard. See page ii for information on non-standard products.



520N - General Hydraulic Hose Meets or Exceeds SAE 100R8 2750 to 5000 PSI



Part Number	I. D.		Max. O. D.		Max. Working Pressure		Min. Bend Radius		Weight		Crimp Fitting		80C Crimp Die
	#												
hose	inch	mm	inch	mm	wpsi	MPa	inch	mm	lbs/ft	kg/m	series	pg	crimp die
520N-3	3/16	5	0.43	11	5000	34.5	1-1/2	38	.05	.07	55	53-77	P03
520N-4	1/4	6	0.51	13	5000	34.5	2	51	.06	.09	55	53-77	P04
520N-5	5/16	8	0.57	14	4500	31.0	2-1/2	64	.07	.10	55	53-77	P05
520N-6	3/8	10	0.65	16	4000	27.6	2-1/2	64	.08	.12	55	53-77	P06
520N-8	1/2	13	0.81	21	3500	24.1	4	102	.13	.19	55	53-77	P08
520N-10 [+]	5/8	16	0.92	23	2750	19.0	6	152	.17	.25	55	53-77	P10

Min. Burst Pressure is 4x Max. Working Pressure

Tube: Nylon
Reinforcement: Aramid fiber
Cover: Urethane
Cover Color: Black, perforated
Temperature Range: -40°F to +212°F
 -40°C to +100°C
Vacuum Rating: 28 inch Hg
(Delta) Working Length @ Rated WPSI: ±2% Max.

Applications/Markets:

Hydraulic and pneumatic circuits and systems
 Ideal in hot water applications
 Not recommended for use in over-the-sheave (pulley system) applications

Special Features:

Twin and multi-line available
 Fast response, lighter and smaller O.D. than 100R2 hose.

528N - Non-Conductive Hose Meets or Exceeds 100R8 2750 to 5000 PSI



Part Number	I. D.		Max. O. D.		Max. Working Pressure		Min. Bend Radius		Weight		Crimp Fitting		80C Crimp Die
	#												
hose	inch	mm	inch	mm	wpsi	MPa	inch	mm	lbs/ft	kg/m	series	pg	crimp die
528N-3 [+]	3/16	5	0.43	11	5000	34.5	1-1/2	38	.05	.07	55	53-77	P03
528N-4	1/4	6	0.51	13	5000	34.5	2	51	.06	.09	55	53-77	P04
528N-5 [+]	5/16	8	0.57	14	4500	31.0	2-1/2	64	.07	.10	55	53-77	P05
528N-6	3/8	10	0.65	16	4000	27.6	2-1/2	64	.08	.12	55	53-77	P06
528N-8	1/2	13	0.81	21	3500	24.1	4	102	.13	.19	55	53-77	P08
528N-10	5/8	16	0.92	23	2750	19.0	6	152	.17	.25	55	53-77	P10

Min. Burst Pressure is 4x Max. Working Pressure

Tube: Nylon
Reinforcement: Aramid fiber
Cover: Urethane
Cover Color: Orange, non-perforated
Temperature Range: -40°F to +212°F
 -40°C to +100°C
Vacuum Rating: 28 inch Hg
(Delta) Working Length @ Rated WPSI: ±3% Max.

Applications/Markets:

Hydraulic circuits and systems
 Ideal in hot water applications
 Not recommended for use in over-the-sheave (pulley system) applications

Special Features:

Twin and multi-line available
 Fast response, lighter and smaller O.D. than 100R2 hose.

Note: The above hose(s) are not intended for use in static discharge applications; i.e., airless paint spray.

53DM - DuraMax™ Low Temperature Meets or Exceeds SAE 100R18 3000 PSI Constant Pressure



Part Number	I. D.		Max. O. D.		Max. Working Pressure		Min. Bend Radius		Weight		55/58 Crimp Fitting and Dies		HY Crimp Die
	#												
hose	inch	mm	inch	mm	wpsi	MPa	inch	mm	lbs/ft	kg/m	series	55/58 Crimp Die	HY Crimp Die
53DM-3	3/16	5	0.425	10.79	3000	21.0	1.00	25	.056	.073	55	80C-P03	N/A
53DM-4	1/4	6	0.485	12.31	3000	21.0	1.25	32	.067	.100	55,HY	80C-P0550	80C-P0550
53DM-5	5/16	8	0.600	15.24	3000	21.0	2.00	51	.100	.149	58,HY	80C-P05R	80C-P05R
53DM-6	3/8	10	0.655	16.63	3000	21.0	2.00	51	.110	.164	55,HY	80C-P0705	80C-P0715
53DM-8	1/2	13	0.840	21.33	3000	21.0	3.50	89	.174	.260	55,HY	80C-P0870	80C-P0870
53DM-10	5/8	16	1.030	26.16	3000	21.0	4.00	102	.219	.327	58	80C-P1045	N/A
53DM-12* [+]	3/4	19	1.130	28.70	3000	21.0	6.50	165	.261	.388	58H	83C-P1258H	N/A

Min. Burst Pressure is 4x Max. Working Pressure

Tube: Polyester

Reinforcement: Fiber

Cover: Polyester

Cover Color: MatteBlack Perforated

Temperature Range: -70°F (-57°C) to +212°F (100°C)
For use with water and water base hydraulic fluids to 150°F (65°C)

Vacuum Rating: 28 inch Hg

(Delta) Working Length @ Rated WPSI: ±2% Max.

* 53DM-12 not for over the sheave

Applications/Markets:

Excellent over-the-sheave in lift truck applications
Cold storage or refrigerated areas
Construction and agriculture equipment in cold climates

Special Features:

Matte Jacket for low coefficient of friction
Superior flexibility in cold temperature applications
Better bend radius than SAE J517 and 100R7
Smaller OD's than 100R7 and 100R18
Light weight
Wide range of fitting selection

53LT - Low Temperature Meets or Exceeds SAE 100R18 3000 PSI Constant Pressure



Part Number	I. D.		Max. O. D.		Max. Working Pressure		Min. Bend Radius		Weight		Crimp Fitting		80C Crimp Die
	#												
hose	inch	mm	inch	mm	wpsi	MPa	inch	mm	lbs/ft	kg/m	series	pg	crimp die
53LT-3	3/16	5	0.43	11	3000	20.68	1-1/4	32	.049	.073	55	53-77	P03
53LT-4	1/4	6	0.51	13	3000	20.68	1-3/4	44	.067	.100	55	53-77	P04
53LT-5	5/16	8	0.61	16	3000	20.68	2.0	51	.104	.155	58	78-102	P05R
53LT-6	3/8	10	0.72	18	3000	20.68	3.0	76	.132	.197	58	78-102	P06FR
53LT-8	1/2	13	0.89	23	3000	20.68	3.5	89	.193	.288	58	78-102	P08H
53LT-10	5/8	16	1.00	25	3000	20.68	4.0	102	.242	.361	58	78-102	P10H
53LT-12	3/4	19	1.24	32	3000	20.68	5.0	127	.354	.527	58H	78-102	83C-P1258K

Min. Burst Pressure is 4x Max. Working Pressure

Tube: Polyester

Reinforcement: Fiber

Cover: Special Polyester Blend

Cover Color: Black Perforated

Temperature Range: -70°F to +212°F
-57°C to +100°C

Vacuum Rating: 28 inch Hg

(Delta) Working Length @ Rated WPSI: ±2% Max.

Applications/Markets:

Excellent over-the-sheave (pulley systems), lift truck
Cold storage or refrigerated areas
Construction and agriculture equipment in cold climates

Special Features:

Superior flexibility in cold temperature applications

Note: The above hose(s) are not intended for use in static discharge applications; i.e., airless paint spray.

538LT - Low Temperature Non-Conductive Meets or Exceeds 100R18



Meets SAE J517 for less than 50 micro-amps leakage under 75000 volts per ft.

Part Number	I. D.		Max. O. D.		Max. Working Pressure		Min. Bend Radius		Weight		Crimp Fitting		80C Crimp Die
	inch	mm	inch	mm	wpsi	MPa	inch	mm	lbs/ft	kg/m	series	pg	crimp die
#													
hose	inch	mm	inch	mm	wpsi	MPa	inch	mm	lbs/ft	kg/m	series	pg	crimp die
538LT-3 (+)	1/5	5	0.43	11	3000	20.68	1-1/4	31.8	0.049	0.073	55	53-77	P03
538LT-4 (+)	1/4	6	0.51	13	3000	20.68	1-3/4	44.5	0.067	0.099	55	53-77	P04
538LT-5 (+)	1/3	8	0.61	16	3000	20.68	2	50.8	0.104	0.154	58	78-102	P05R
538LT-6 (+)	3/8	10	0.71	18	3000	20.68	3	76.2	0.132	0.195	58	78-102	P06FR
538LT-8 (+)	1/2	13	0.89	23	3000	20.68	3-1/2	88.9	0.193	0.286	58	78-102	P08H
538LT-10 (+)	5/8	16	1.00	25	3000	20.68	4	101.6	0.141	0.358	58	78-102	P10H
538LT-12 (+)	3/4	19	1.24	32	3000	20.68	5	127.0	0.354	0.524	58H	78-102	83C-P1258K

Min. Burst Pressure is 4x Max. Working Pressure

Tube: Polyester

Reinforcement: Fiber

Cover: Special Polyester Blend

Cover Color: Orange, non-perforated

Temperature Range: -70°F to +212°F

-57°C to +100°C

Vacuum Rating: 28 inch Hg

(Delta) Working Length @ Rated WPSI: ±2% Max.

Applications/Markets:

Hydraulic systems on utility vehicles and equipment for constant working pressures. For locations around and in contact with high voltage.

Special Features:

Twin and multi-line available

Optimum kink resistance

Superior flexibility in cold temperature applications

Note: The above hose(s) are not intended for use in static discharge applications; i.e., airless paint spray.

(+) Non Standard. See page ii for information on non-standard products.

540N - General Hydraulic Hose Meets or Exceeds SAE 100R7 1250 to 3000 PSI



Part Number	I. D.		Max. O. D.		Max. Working Pressure		Min. Bend Radius		Weight		Crimp Fitting		80C Crimp Die
	#												
hose	inch	mm	inch	mm	wpsi	MPa	inch	mm	lbs/ft	kg/m	series	pg	crimp die
540N-2	1/8	3	0.34	9	3000	20.68	1/2	13	.031	.046	57	53-77	P02H
540N-3	3/16	5	0.43	11	3000	20.68	3/4	19	.043	.064	55	53-77	P03
540N-4	1/4	6	0.51	13	2750	18.96	1-1/2	38	.057	.085	55	53-77	P04
540N-5	5/16	8	0.57	14	2500	17.24	1-3/4	44	.068	.101	55	53-77	P05
540N-6	3/8	10	0.65	16	2250	15.51	2	51	.086	.128	55	53-77	P06
540N-8	1/2	13	0.81	21	2000	13.79	3	76	.126	.188	55	53-77	P08
540N-12	3/4	19	1.06	27	1250	8.62	6	152	.168	.250	55	53-77	P12

Min. Burst Pressure is 4x Max. Working Pressure

Tube: Nylon

Reinforcement: Fiber

Cover: Matte finish urethane

Cover Color: Black, perforated

Temperature Range: -40°F to +212°F

-40°C to +100°C

Vacuum Rating: 28 inch Hg

[Delta] Working Length @ Rated WPSI: ±2% Max.

Applications/Markets:

Hydraulic and pneumatic systems. Excellent chemical compatibility, wide temperature range, agricultural spraying, urethane foam mixers, robotics, fire resistant fluid and hot water.

Special Features:

Special order colors. Twin or multi-line available. Greater range of fluid compatibility than SAE 100R1 hose.

Note: The above hose(s) are not intended for use in static discharge applications; i.e., airless paint spray.

PTFE Hose & Fittings

Thermoplastic Tubing

Coiled Air Hose, Fittings & Accessories

Truck (Fleet) Products

Tooling & Equipment

Hose Accessories

Technical & Design Information

Approvals & Guides

Alphanumeric Index

55LT - Low Temperature Hose Meets or Exceeds SAE 100R7 1250 to 3250 PSI



Part Number	I. D.		Max. O. D.		Max. Working Pressure		Min. Bend Radius		Weight		Crimp Fitting		80C Crimp Die
	#												
hose	inch	mm	inch	mm	wpsi	MPa	inch	mm	lbs/ft	kg/m	series	pg	crimp die
55LT-2	1/8	3	0.34	9	3000	20.68	1/2	13	.031	.046	57	53-77	P02H
55LT-3	3/16	5	0.43	11	3250	22.41	3/4	19	.053	.079	55	53-77	P03
55LT-4	1/4	6	0.51	13	3000	20.68	1-1/4	32	.067	.100	55	53-77	P04
55LT-5	5/16	8	0.57	14	2500	17.24	1-3/4	44	.085	.127	55	53-77	P05
55LT-6	3/8	10	0.65	16	2250	15.51	2	51	.096	.143	55	53-77	P06
55LT-8	1/2	13	0.81	21	2000	13.79	3	76	.143	.213	55	53-77	P08
55LT-12 (+)	3/4	19	1.09	28	1250	8.62	5	127	.206	.307	55	53-77	P12

Min. Burst Pressure is 4x Max. Working Pressure

- Tube:** Polyester
- Reinforcement:** Fiber
- Cover:** Special Polyester Blend
- Cover Color:** Black, perforated
- Temperature Range:** -70°F to +212°F
-57°C to +100°C

(Limited to +135°F (+57°C) for synthetic hydraulic fluids and water based fluids.)

Vacuum Rating: 28 inch Hg

(Delta) Working Length @ Rated WPSI: ±2% Max.

Applications/Markets:

- Hydraulic systems exposed to very low temperatures
- Excellent over-the-sheave (pulley systems), lift truck
- Cold storage or refrigerated areas
- Construction and agriculture equipment in cold climates

Special Features:

- Twin and multi-line available
- Superior flexibility in cold temperature applications

573X - Fast Response Hose 3000 PSI Constant Pressure



Part Number	I. D.		Max. O. D.		Max. Working Pressure		Min. Bend Radius		Weight		Crimp Fitting	
	#											
hose	inch	mm	inch	mm	wpsi	MPa	inch	mm	lbs/ft	kg/m	series	pg
573X-3	3/16	5	0.35	9	3000	20.68	2	51	.030	.045	LV	41
573X-16	1	25	1.47	37	3000	20.68	10	25	.405	.603	LV	41

Min. Burst Pressure is 4x Max. Working Pressure

- Tube:** Nylon
- Reinforcement:** Aramid fiber
- Cover:** Urethane
- Cover Color:** Black non-perforated
- Temperature Range:** -40°F to +212°F
-40°C to +100°C

Vacuum Rating: 28 inch Hg

(Delta) Working Length @ Rated WPSI: ±2% Max.

Applications/Markets:

- Marine, offshore drilling
- Anywhere fast, accurate response time is required

Special Features:

- Fast response even over longer lengths
- Factory made assemblies only**

Note: The above hose(s) are not intended for use in static discharge applications; i.e., airless paint spray.



Hydraulic & Pneumatic Hose & Fit.
PTFE Hose & Fittings
Thermoplastic Tubing
Coiled Air Hose, Fittings & Accessories
Truck (Fleet) Products
Tooling & Equipment
Hose Accessories
Technical & Design Information
Approvals & Guides
Alphanumeric Index

575X - Fast Response Hose 5000 PSI Constant Pressure



Part Number	I. D.		Max. O. D.		Max. Working Pressure		Min. Bend Radius		Weight		Crimp Fitting		80C Crimp Die
	#	inch	mm	inch	mm	wpsi	MPa	inch	mm	lbs/ft	kg/m	series	pg
575X-3	3/16	5	0.43	11	5000	34.47	1.5	38	.050	.075	55	53-77	P03
575X-4	1/4	6	0.51	13	5000	34.47	2.0	51	.068	.101	55	53-77	P04
575X-6	3/8	10	0.64	16	5000	34.47	3.0	76	.090	.134	55	53-77	P06
575X-8	1/2	13	0.81	21	5000	34.47	4.0	102	.139	.207	55	53-77	P08
575X-12	3/4	19	1.15	29	5000	34.47	8.0	203	.241	.359	58H	78-102	83C-P1258H
575X-16	1	25	1.59	40	5000	34.47	10.0	254	.360	.536	58H	78-102	83C-P1658H

Min. Burst Pressure is 4x Max. Working Pressure

Tube: Nylon

Reinforcement: Fiber

Cover: Urethane

Cover Color: Black, non-perforated

Temperature Range: -40°F to +212°F
-40°C to +100°C

Vacuum Rating: 28 inch Hg

(Delta) Working Length @ Rated WPSI: ±2% Max.

Applications/Markets:

Marine, offshore drilling

Anywhere fast, accurate response time is required

Special Features:

Fast response even over longer lengths

580N/H580N - High Pressure Hose Meets or Exceeds 100R8 2000 to 5000 PSI Pressure Range



Part Number	I. D.		Max. O. D.		Max. Working Pressure		Min. Bend Radius		Weight		Crimp Fitting	
	#	inch	mm	inch	mm	wpsi	MPa	inch	mm	lbs/ft	kg/m	series
580N-4	1/4	6	0.62	16	5000	34.47	2.0	51	.118	.176	58	78-102
580N-6	3/8	10	0.77	20	4000	27.58	2.5	64	.15	.224	58	78-102
580N-8	1/2	13	0.89	23	3500	24.13	4.0	102	.206	.307	58	78-102
580N-10 (+)	5/8	16	0.98	25	2750	18.96	6.0	152	.21	.313	58	78-102
580N-12	3/4	19	1.16	29	2250	15.51	8.0	203	.232	.346	58	78-102
580N-16	1	25	1.48	38	2000	13.79	10.0	254	.376	.560	58	78-102
H580N-16	1	25	1.58	40	3000	20.68	10.0	254	.529	.788	58H	78-102

Min. Burst Pressure is 4x Max. Working Pressure

Tube: Nylon

Reinforcement: Fiber

Cover: Abrasion resistant urethane*

Cover Color: Black, perforated

Temperature Range: -40°F to +212°F (-40°C to +100°C)

Vacuum Rating: 28 inch Hg

(Delta) Working Length @ Rated WPSI: ±2%

* H580N-16 IS NOT COVER PERFORATED

Applications/Markets:

Hydraulic and pneumatic circuits and systems. Replaces 100R2 rubber hose wherever greater flexibility, fluid compatibility, and cover durability are required. Lighter weight and smaller O.D. than 100R2. Long lengths are available.

Special Features:

Meets or exceeds SAE 100R8 specifications.

588N - High Pressure, Non-Conductive Hose Meets or Exceeds 100R8 2000 to 5000 PSI Pressure Range



Part Number	I. D.		Max. O. D.		Max. Working Pressure		Min. Bend Radius		Weight		Crimp Fitting	
	inch	mm	inch	mm	wpsi	MPa	inch	mm	lbs/ft	kg/m	series	pg
#												
hose	inch	mm	inch	mm	wpsi	MPa	inch	mm	lbs/ft	kg/m	series	pg
588N-4	1/4	6	.62	16	5000	34.47	2.0	51	.118	.176	58	78-102
588N-6	3/8	10	.77	20	4000	27.58	2..5	64	.150	.224	58	78-102
588N-8	1/2	13	.89	23	3500	24.13	4	102	.206	.307	58	78-102
588N-10	5/8	16	.98	25	2750	18.96	6	152	.210	.313	58	78-102
588N-12	3/4	19	1.16	29	2250	15.51	8	203	.232	.346	58	78-102
588N-16	1	25	1.48	38	2000	13.79	10	254	.376	.560	58	78-102

Min. Burst Pressure is 4x Max. Working Pressure

Tube: Nylon
Reinforcement: Fiber
Cover: Abrasion resistant urethane
Cover Color: Orange, non-perforated
Temperature Range: -40°F to +212°F (-40°C to +100°C)
Vacuum Rating: 28 inch Hg
(Delta) Working Length @ Rated WPSI: ±2%

Special Features:

Meets SAEJ517 for less than 50 micro-amps leakage under 75000 volts per ft. Meets or exceeds SAE 100R8 specifications, and Ontario Hydro electrical standards.

Twin-line or multi-line constructions available.

Applications/Markets:

Hydraulic circuits and systems. Replaces 100R2 hose wherever greater flexibility, fluid compatibility, electrical nonconductivity, and cover durability are required. For hydraulic circuits and systems found on utility vehicles and equipment where exposure and contact with high voltage may be encountered.

Note: The above hose(s) are not intended for use in static discharge applications; i.e., airless paint spray.

83FR - DuraGard™ General Purpose Urethane 300 PSI



Part Number	I. D.		Max. O. D.		Max. Working Pressure		Min. Bend Radius		Weight		Crimp Fitting		80C Crimp Die	Push-Lok Fitting*	
	#	inch	mm	inch	mm	wpsi	MPa	inch	mm	lbs/ft	kg/m	series	pg	crimp die	re
83FR-4	1/4	6	.47	12	300	2.1	1.0	25.4	.05	.07	HY*/55	112-128/53-77	P04	82	*
83FR-6	3/8	10	.59	15	300	2.1	2.0	50.8	.08	.12	HY*/55	112-128/53-77	P06	82	*
83FR-8	1/2	13	.75	19	300	2.1	2.5	63.5	.12	.18	HY*/55	112-128/53-77	P08J	82	*
83FR-12	3/4	19	1.03	26	300	2.1	3.5	88.9	.19	.28	HY*/55	112-128/53-77	P12	82	*

Min. Burst Pressure is 4x Max. Working Pressure

Tube: Specially formulated urethane
Reinforcement: Fiber
Cover: Urethane MSHA approved
Cover Color: Blue, Green
 Black, Gray, Brown, Red
Temperature Range: -20°F to +200°F
 -29°C to +93°C
Vacuum Rating: 28 inch Hg
(Delta) Working Length @ Rated WPSI: ±2%

Special Features:
 Weld spatter resistance
 Extreme flexibility
 Non-conductive (SAEJ343)
 Excellent abrasion resistance
 Small bend radius
 * Note: Temperature and pressure reduced with 82 series
Push-Lok Fitting: * -20°F to +145°F
 * -29°C to +63°C
 175 Maximum working pressure

Applications/Markets:
 General purpose air and water hose often used in robotic welding applications

* Series HY & 82 fittings available from Hose Products Division

HJK - Highjack® Jackline Hybrid Hose 10,000 PSI



Part Number	I. D.		Max. O. D.		Max. Working Pressure		Min. Bend Radius		Weight	
	#	inch	mm	inch	mm	wpsi	MPa	inch	mm	lbs/ft
HJK04	1/4	6	.60	15	10000	69	4.0	101.6	.27	.40

Min. Burst Pressure is 3x Max. Working Pressure

Tube: Polyester
Reinforcement: 2 braids of high tensile wire
Cover: Smooth synthetic rubber-MSHA approved
Cover Color: Black
Temperature Range: -40°F to +150°F
 -40°C to +65°C

Applications/Markets:
 Used for High Pressure Jackline applications. Not for high impulse applications
Special Features:
 Meets IJ-100 requirements
Factory made assemblies only

(Limited to +135°F [+57°C] for synthetic hydraulic fluids and water-based fluids)

Vacuum Rating: 28 inch Hg
(Delta) Working Length @ Rated WPSI: +2% / -4%

53GW - Grease Whip Hose 3000 PSI



Part Number	I. D.		Max. O. D.		Max. Working Pressure		Min. Bend Radius		Weight	
	#									
hose	inch	mm	inch	mm	wpsi	MPa	inch	mm	lbs/ft	kg/m
53GW-2	1/8	3.2	.32	8.0	3000	20.7	.5	12.7	.03	.04
53GW-3	3/16	4.8	.41	10.4	3000	20.7	.8	20.32	.06	.08

Min. Burst Pressure is 4x Max. Working Pressure

Tube: Polyester
Reinforcement: Polyester
Cover: Urethane
Cover Color: Black
Temperature Range: -40°F to +212°F
 -40°C to +100°C

Vacuum Rating: 28 inch Hg
(Delta) Working Length @ Rated WPSI: ±2% Max

Applications/Markets:

Grease guns

Special Features:

Light weight

Note: Parker assembled hoses only

PTFE
Hose &
FittingsThermoplastic
TubingCoiled Air Hose,
Fittings
& AccessoriesTruck (Fleet)
Products

HLB - Lubrication Line Hose 3000 PSI

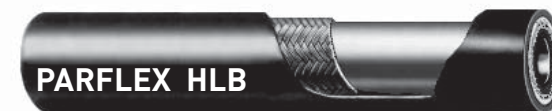

Part Number	I. D.		Max. O. D.		Max. Working Pressure		Min. Bend Radius		Weight		Crimp Fitting	80C Crimp Die
	#											
hose	inch	mm	inch	mm	wpsi	MPa	inch	mm	lbs/ft	kg/m		
HLB02	1/8	3.2	.32	8.0	3000	20.7	.5	12.7	.03	.04	CY	
HLB03	3/16	4.8	.41	10.4	3000	20.7	.8	20.32	.06	.08	CY	P0505

Min. Burst Pressure is 4x Max. Working Pressure

Tube: Polyester
Reinforcement: Polyester
Cover: Urethane
Cover Color: Black
Temperature Range: -40°F to +212°F with CY fittings
Vacuum Rating: 28 inch Hg
(Delta) Working Length @ Rated WPSI: ±2% Max

Applications/Markets:

Grease and lubrication lines.

Special Features:

Light weight

Note: Not for use with hand operated grease guns

Tooling &
EquipmentHose
AccessoriesTechnical &
Design
InformationApprovals &
GuidesAlphanumeric
Index

Note: The HLB hose is not intended for use in static discharge applications; i.e., airless paint spray.

HPS - Paint Spray 3000 PSI



PTFE Hose & Fittings

Thermoplastic Tubing

Coiled Air Hose, Fittings & Accessories

Truck (Fleet) Products

Tooling & Equipment

Hose Accessories

Technical & Design Information

Approvals & Guides

Alphanumeric Index

Part Number	I. D.		Max. O. D.		Max. Working Pressure		Min. Bend Radius		Weight		Crimp Fitting	
	#	inch	mm	inch	mm	wpsi	MPa	inch	mm	lbs/ft	kg/m	series
HPS04	1/4	6	.50	13	3000	20.68	2.0	50.8	.07	.10	HY*	112-128

Min. Burst Pressure is 4x Max. Working Pressure

*Available from Hose Products Division

Tube: Nylon
Reinforcement: Fiber
Cover: Urethane
Cover Color: Black, non-perforated
Temperature Range: -40°F to +180°F
 -40°C to +82°C
Vacuum Rating: 28 inch Hg
(Delta) Working Length @ Rated WPSI: +2% / -4%

Applications/Markets:
 Static conductive airless paint spray hose
Special Features:
 Tube resists paints, lacquers and thinners
Factory made assemblies only

MSH - Marine Steering Fast Response Hose 1000 PSI Constant Pressure



Part Number	I. D.		Max. O. D.		Max. Working Pressure		Min. Bend Radius		Weight		Crimp Fitting		80C Crimp Die	Field Attachable Fitting	
	#	inch	mm	inch	mm	wpsi	MPa	inch	mm	lbs/ft	kg/m	series	pg	crimp die	re
MSH-5	5/16	8	0.48	12	1000	6.89	2-1/4	57	.049	.073	108MS	40	M05	208MS	40
MSH-6	3/8	10	0.59	15	1000	6.89	3	76	.072	.107	108MS	40	M06	208MS	40

Min. Burst Pressure is 4x Max. Working Pressure

Tube: Nylon
Reinforcement: Fiber
Cover: Urethane
Cover Color: Black, non-perforated
Temperature Range: -40°F to +212°F
 -40°C to +100°C
 (Limited to +135°F (+57°C) for synthetic hydraulic fluids and water-based fluids)
Vacuum Rating: 28 inch Hg
(Delta) Working Length @ Rated WPSI: ±2% Max.

Applications/Markets:
 Wide range of marine applications
Special Features:
 Fast accurate response
 Factory or field attachable, swageable
 Salt water, corrosion resistant

Note: The above hose(s) are not intended for use in static discharge applications; i.e., airless paint spray.



MTH - DOT Marine Trailer Hose 1000 PSI



Part Number	ID		OD		Max. Working Pressure		Min. Bend Radius		Weight		Crimp Fittings	
#												
hose	inch	mm	inch	mm	wpsi	MPa	inch	mm	lbs/ft	kg/m	series	pg
MTH-4-DOT	0.200	5	0.365	9	1,000	6.9	3/4	19	0.032	.047	91N	150-164
80C-MTH4	CRIMP DIE											

Min. Burst Pressure is 4x Max. Working Pressure

Tube: Nylon
Reinforcement: Fiber
Cover: Abrasion resistant non-perforated black urethane
Temperature Range: -40°F to +212°F (-40°C to +100°C) [+212°F (+100°C) per SAE J1401]

Fast response hose

- **Recreational Trailer Brake Systems Only**
- Lightweight thermoplastic hose
- Specifically designed for tow-behind trailers
- Easy and flexible for routing
- Corrosion resistant
- Replaces expensive steel or stainless steel tubing.
- Simplified installation
- Meets or exceeds SAE J1401

PTH - Marine Power Tilt Hose 3000 PSI



Part Number	I. D.		Max. O. D.		Max. Working Pressure		Min. Bend Radius		Weight		Crimp Fitting		80C Crimp Die
#													
hose	inch	mm	inch	mm	wpsi	MPa	inch	mm	lbs/ft	kg/m	series	pg	crimp die
PTH-3	3/16	5	0.43	11	3000	20.68	3/4	19	.075	.112	92	103-104	T05

Min. Burst Pressure is 4x Max. Working Pressure

Tube: Nylon
Reinforcement: Fiber & stainless steel braid
Cover: Urethane
Cover Color: Clear non-perforated
Temperature Range: -40°F to +212°F (-40°C to +100°C)
Vacuum Rating: 28 inch Hg

(Delta) Working Length @ Rated WPSI: ±2% Max.
Applications/Markets: Power tilt mechanisms for outboard & stern drive engines
Special Features: Also available in bubble packed assembly
 Corrosion resistant

Note: The above hose is not intended for use in static discharge applications; i.e., airless paint spray.

Hydraulic & Pneumatic Hose & Fit.

PTFE Hose & Fittings

Thermoplastic Tubing

Coiled Air Hose, Fittings & Accessories

Truck (Fleet) Products

Tooling & Equipment

Hose Accessories

Technical & Design Information

Approvals & Guides

Alphanumeric Index

S4 - Predator® Hose Water Jetting/Lateral Cleaning 4000 PSI Constant Pressure



Part Number	I. D.		Max. O. D.		Max. Working Pressure		Min. Bend Radius		Weight		Crimp Fitting		80C Crimp Die
	#	inch	mm	inch	mm	wpsi	MPa	inch	mm	lbs/ft	kg/m	series	pg
S408	1/2	13	.89	23	4000	27.6	4	102	.20	.30	HY*/58	112-128/78-102	P08H
S410	5/8	16	1.06	27	4000	27.6	5	127	.32	.48	43	-	P1130

Min. Burst Pressure is 2.5x Max. Working Pressure

*HY Series Available from Hose Products Division

Tube: Gray Polyester
Reinforcement: Fiber
Cover: Abrasion Resistant Urethane
Cover Color: Green
Temperature Range: -40°F to +135°F for water

Applications/Markets:

High pressure water equipment for cleaning or debris removal in lateral sewer lines. These lines provide connection from commercial, industrial or residential structure to the main sewer line located under the streets. The lateral lines are smaller in di-

ameter than the main lines, and rely more on water pressure than water volume to clear residue and obstructions. For water/slurry applications, contact Parflex for chemical compatibility/recommendations. Not for use in hydraulic applications.

Special Features:

Meets NSWMA (National Solid Waste Management Association) and WASTEC (Waste Equipment Technology Association), WEMI (Waste Equipment Management Institute), and specifications for repair/inspection procedures for high pressure hose used in conjunction with sewer/catch basin cleaning equipment

Easily identified lime green cover signifies 4000 psiw
 Factory assemblies feature rigid male x rigid male fittings

S5 - Predator® Hose Water Jetting/Lateral Cleaning 4000 PSI Constant Pressure



Part Number	I. D.		Max. O. D.		Max. Working Pressure		Min. Bend Radius		Weight		Crimp Fitting		80C Crimp Die
	#	inch	mm	inch	mm	wpsi	MPa	inch	mm	lbs/ft	kg/m	series	pg
S506	3/8	9.5	0.64	16.2	4000	27.6	2.5	63.5	0.11	0.165	HY*	112-128	†
S508	1/2	13	.80	20	4000	27.6	4	102	.16	.24	55/HY	53-77/112-128	P08/†
S510	5/8	16	1.06	27	4000	27.6	5	127	.32	.48	43	-	P1130

*HY Series Available from Hose Products Division

Tube: Gray Polyester
Reinforcement: Aramid Fiber (S506 & S508)
 Fiber (S510)
Cover: Abrasion Resistant Urethane, perforated
Cover Color: Green
Temperature Range: -40°F to +135°F for water

Applications/Markets:

High pressure water equipment for cleaning or debris removal in lateral sewer lines. These lines provide connection from commercial, industrial or residential structure to the main sewer line located under the streets. The lateral lines are smaller in diameter than the main lines, and rely more on water pressure than water volume to clear residue and obstructions. For water/slurry applications, contact Parflex for chemical compatibility/recommendations. Not for use in hydraulic applications.

Special Features:

Meets NSWMA (National Solid Waste Management Association) and WASTEC (Waste Equipment Technology Association), WEMI (Waste Equipment Management Institute), and specifications for repair/inspection procedures for high pressure hose used in conjunction with sewer/catch basin cleaning equipment

Easily identified lime green cover signifies 4000 psiw
 Factory assemblies feature rigid male x rigid male fittings
 Slim profile and light weight provide easy handling and routing

Min. Burst Pressure:

3/8 = 4:1 (16,000 PSI)
 1/2 = 4:1 (16,000 PSI)
 5/8 = 3:1 (12,000 PSI)

†See crimp source online for HY on S5 hose

Note: The above hose(s) are not intended for use in static discharge applications; i.e., airless paint spray.

(+) Non Standard. See page ii for information on non-standard products.

S6 - Predator® Hose Sewer Cleaning 2500 PSI Constant Pressure

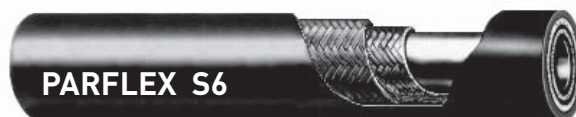

Part Number	I. D.		Max. O. D.		Max. Working Pressure		Min. Bend Radius		Weight		Crimp Fitting		80C Crimp Die
	#	inch	mm	inch	mm	wpsi	MPa	inch	mm	lbs/ft	kg/m	series	pg
S612	3/4	19	1.14	29	2500	17.2	4	102	.290	.33	HY/58	112-128/78-102	80C-P12H
S616	1	25	1.41	36	2500	17.2	6	152	.380	.57	HY/58	112-128/78-102	80C-P1450
S620	1-1/4	32	1.78	45	2500	17.2	12	305	.610	.91	*SQ	110	83C-T24
S624 **(+)	1-1/2	38	2.10	53	2500	17.2	15	381	.830	1.24	71	***	83C-D24

Min. Burst Pressure is 2.5x Max. Working Pressure

***Available from Hose Products Division

Tube: Gray Polyester

Reinforcement: Fiber

Cover: Abrasion Resistant Perforated Polyurethane

Cover Color: Orange

Temperature Range: -40°F to +135°F for water

Applications/Markets:

High pressure and high volume water equipment for cleaning or debris removal in large sewer lines. For water/slurry applications, contact Parflex for chemical compatibility/recommendations. Not for use in hydraulic applications.

Special Features:

Meets NSWMA (National Solid Waste Management Association) and WASTEC (Waste Equipment Technology Association), WEMI (Waste Equipment Management Institute), and specifications for repair/inspection procedures for high pressure hose used in conjunction with sewer/catch basin cleaning equipment

Easily identified orange cover signifies 2500 psiw

Bonded construction provides excellent kink resistance and flexibility

Factory assemblies feature rigid male x rigid male fittings

*Swaged - Factory made assemblies only

**Nylon

Note: SQ, HY, 58 Series approved for field repair

S9 - Predator® Hose Sewer Cleaning 3000 PSI Constant Pressure



Part Number	I. D.		Max. O. D.		Max. Working Pressure		Min. Bend Radius		Weight		Crimp Fitting		80C Crimp Die
	#	inch	mm	inch	mm	wpsi	MPa	inch	mm	lbs/ft	kg/m	series	pg
S912	3/4	19	1.15	29	3000	20.7	4	102	.30	.45	HY/58	112-128/78-102	80C-P12H
S916	1	25	1.47	37	3000	20.7	8	203	.46	.69	HY/58	112-128/78-102	80C-P1490

Min. Burst Pressure is 2.5x Max. Working Pressure

Note: SQ, HY, 58 Series approved for field repair

Tube: Gray Polyester

Reinforcement: Fiber

Cover: Abrasion Resistant Perforated Polyurethane

Cover Color: Blue

Temperature Range: -40°F to +135°F for water

Applications/Markets:

High pressure and high volume water equipment for cleaning or debris removal in large sewer lines. For water/slurry applications, contact Parflex for chemical compatibility/recommendations. Not for use in hydraulic applications.

Special Features:

Meets NSWMA (National Solid Waste Management Association) and WASTEC (Waste Equipment Technology Association), WEMI (Waste Equipment Management Institute), and specifications for repair/inspection procedures for high pressure hose used in conjunction with sewer/catch basin cleaning equipment

Easily identified blue cover signifies 3000 psiw

Bonded construction provides excellent kink resistance and flexibility

Factory assemblies feature rigid male x rigid male fittings

Note: The above hose(s) are not intended for use in static discharge applications; i.e., airless paint spray.

(+) Non Standard. See page ii for information on non-standard products.



Hydraulic & Pneumatic Hose & Fit.
PTFE Hose & Fittings
Thermoplastic Tubing
Coiled Air Hose, Fittings & Accessories
Truck (Fleet) Products
Tooling & Equipment
Hose Accessories
Technical & Design Information
Approvals & Guides
Alphanumeric Index

CNG - Electrically Conductive Compressed Natural Gas Hose 3600 to 5000 PSI

Conforms to NFPA 52, ANSI/IAS NGV 4.2-1999 • CSA 12.52-M99



Part Number	I. D.		Max. O. D.		Max. Working Pressure		Min. Bend Radius		Weight		Wire Spring Guard Part Number*	Vinyl Guard Part Number	Crimp Fitting	
	#							#	#		#	#		
hose	inch	mm	inch	mm	wpsi	MPa	inch	mm	lbs/ft	kg/m			series	pg
3CNG-4	1/4	6	0.52	13	3600	248	2	50.8	.62	9.2	3PSG-4	CNKG3-4	55	53-77
3CNG-6	3/8	10	0.77	20	3600	248	2-1/2	63.5	.150	22.4	5PSG-6	CNKG3-6	58	78-102
4CNG-6	3/8	10	0.77	20	4000	276	2-1/2	63.5	.150	22.4	5PSG-6	CNKG3-6	58	78-102
5CNG-3	3/16	5	0.43	11	5000	345	1-1/2	38.1	.50	7.4	3PSG-3	CNKG5-3	55	53-77
5CNG-4	1/4	6	0.62	16	5000	345	2	50.8	.110	16.4	5PSG-4	CNKG5-4	58	78-102
5CNG-6	3/8	10	0.77	20	5000	345	3	76.2	.170	25.3	5PSG-6	CNKG3-6	58	78-102
5CNG-8	1/2	13	0.89	23	5000	345	4	101.6	.205	30.5	5PSG-8	CNKG5-8	58	78-102
5CNG-12	3/4	19	1.15	28	5000	345	7-1/2	191	.241	35.9	-	CNKG5-12	58H	78-102
5CNG-16	1	25	1.59	40	5000	345	10	254	.358	53.3	-	CNKG5-16	58H	76-100

*Wire spring guards must be used on ANSI/CSA design certified CNG dispenser fill hose assemblies. Hose sizes -3 through -8; single and multi-line bonded assemblies. Vinyl guards are used on hose sizes -12 and -16.

Min. Burst Pressure is 4x Max. Working Pressure

Tube: Electrically Conductive Nylon

Reinforcement: Fiber

Cover: Urethane, perforated

Cover Color: Red

Temperature Range: -40°F to +180°F
-40°C to +82°C

Vacuum Rating: 28 inch Hg

(Delta) Working Length @ Rated WPSI: N/A

Note: CNG hose must be assembled at the factory or by a Parflex-approved facility

Applications/Markets:

Refueling hose specially designed for conveying compressed natural gas. Dissipates static build-up.

Special Features:

Twin and multi-line available
Optional green cover for 5CNG-X-GRN

Note: The above hose(s) are not intended for use in static discharge applications; i.e., airless paint spray.

526BA- Breathing Air Refill Hose 6000 PSI Constant Pressure



Complies with CGA G7.1-1997 Grade E Breathing Air Standards NFPA 1901

Part Number	I. D.		Max. O. D.		Max. Working Pressure		Min. Bend Radius		Weight		Crimp Fitting		80C Crimp Die
	#	inch	mm	inch	mm	wpsi	MPa	inch	mm	lbs/ft	kg/m	series	pg
526BA-3	3/16	5	0.42	11	6000	41.37	1-1/2	38	.050	.075	55	53-77	P03
526BA-4	1/4	6	0.50	13	6000	41.37	2	51	.065	.097	55	53-77	P04
526BA-6	3/8	10	0.64	16	6000	41.37	3	76	.090	.134	55	53-77	P06

Min. Burst Pressure is 4x Max. Working Pressure

Tube: Nylon
Reinforcement: Aramid Fiber
Cover: Urethane
Cover Color: Gray perforated
Temperature Range: -40°F to +180°F
 -40°C to +82°C
Vacuum Rating: 28 inch Hg
(Delta) Working Length @ Rated WPSI: ±2% Max.
Applications/Markets:
 Air compressor stations
 SCUBA tank refilling stations, mobile air wagons
 Cascade systems

Special Features:
 Spring guards available and recommended for abusive applications
 Twin and multi-line available
Note: Not for use as part of SCBA systems
 Lubricate only with water or water (soap) for fitting attachment if needed
 Do not use oil lubricants
Note: This hose is not for use between a pressure reducing regulator and breathing masks. This hose does not contain a conductive element; therefore, it should not be used with explosive gases such as pure oxygen and hydrogen.

540P - Specialty Water Hose 1250 to 2750 PSI



Part Number	I. D.		Max. O. D.		Max. Working Pressure		Min. Bend Radius		Weight		Crimp Fitting		80C Crimp Die
	#	inch	mm	inch	mm	wpsi	MPa	inch	mm	lbs/ft	kg/m	series	pg
540P-4	1/4	6	0.50	13	2750	18.96	1-1/4	32	.052	.077	55	53-77	P04
540P-6	3/8	10	0.65	16	2250	15.51	2.00	51	.086	.128	55	53-77	P06
540P-8	1/2	13	0.81	21	2000	13.79	3.00	76	.126	.188	55	53-77	P08
540P-10 (+)	5/8	16	0.98	25	1500	10.34	4.00	102	.165	.246	55	53-77	P10
540P-12	3/4	19	1.06	27	1250	8.62	6.00	152	.170	.253	55	53-77	P12

Min. Burst Pressure is 4x Max. Working Pressure

Tube: Polyethylene
Reinforcement: Fiber
Cover: Polyurethane
Cover Color: Aqua perforated
Temperature Range: -10°F to +150°F
 -23°C to +66°C
Vacuum Rating: 28 inch Hg
(Delta) Working Length @ Rated WPSI: ±2% Max.

Applications/Markets:
 Potable water delivery to remote sites
 Distilled and de-ionized water
 Low moisture permeability
Special Features:
 Custom colors
 Long lengths
 Plasticizer free non-leaching core tube

Note: The above hose(s) are not intended for use in static discharge applications; i.e., airless paint spray.

(+) Non Standard. See page ii for information on non-standard products.

56DH/568DH - Diagnostic Hose



PTFE Hose & Fittings

Thermoplastic Tubing

Coiled Air Hose, Fittings & Accessories

Truck (Fleet) Products

Tooling & Equipment

Hose Accessories

Technical & Design Information

Approvals & Guides

Alphanumeric Index

Part Number	I. D.		Max. O. D.		Max. Working Pressure		Min. Bend Radius		Weight		Crimp Fitting		80C Crimp Die
	inch	mm	inch	mm	wpsi	MPa	inch	mm	lbs/ft	kg/m	series	pg	crimp die
#													
56DH-1.5 (+)	.090	2.3	.21	5.3	6000	41.37	1/4	6.4	.011	.016	SF	*	T03
568DH-1.5 (+)	.090	2.3	.21	5.3	6000	41.37	1/4	6.4	.011	.016	SF	*	T03
56DH-2	.142	3.6	.32	8.13	6000	41.37	1/2	12.7	.018	.051	CY	*	P0368
568DH-2 (+)	.142	3.6	.32	8.13	6000	41.37	1/2	12.7	.018	.051	CY	*	P0368

Min. Burst Pressure is 4x Max. Working Pressure

- Tube:** Nylon
- Reinforcement:** Aramid Fiber
- Cover:** Urethane
- Cover Color:** Black (56DH) perforated standard
Orange (568DH) non-perforated, non-conductive standard
Other colors available upon request
- Temperature Range:** -40°F to +212°F (-40°C to +100°C)

(Delta) Working Length @ Rated WPSI: ±2% Max.

- Applications/Markets:** Hydraulic test equipment for lab and field use
- Special Features:** Fast response
*Consult Parflex for fitting configurations

1035A - Power Cleaning 1200 to 1500 PSI



Part Number	I. D.		Max. O. D.		Max. Working Pressure		Min. Bend Radius		Weight		Crimp Fitting		80C Crimp Die
	inch	mm	inch	mm	wpsi	MPa	inch	mm	lbs/ft	kg/m	series	pg	crimp die
#													
hose	inch	mm	inch	mm	wpsi	MPa	inch	mm	lbs/ft	kg/m	series	pg	crimp die
1035A-4	1/4	6	0.52	13	1500	10.4	5/8	15.9	.084	.12	55	53-77	P04
1035A-6	3/8	10	0.65	17	1200	8.3	7/8	22.2	.100	.15	55	53-77	P06

*HBR (Hose Bend Restrictor) suggested for carpet cleaning applications. See hose guard in Hose Accessories section.

Min. Burst Pressure is 4x Max. Working Pressure

Tube: Special PFX Compound

Reinforcement: Fiber

Cover: Urethane, perforated

Cover Color: Blue

Temperature Range: -25°F to +212°F

-32°C to +100°C

Vacuum Rating: 28 inch Hg

(Delta) Working Length @ Rated WPSI: ±2% Max.

Applications/Markets:

Water applications

Carpet cleaning

Note: No chlorinated solvents should be used

Special Features:

Optional colors

Non-marring

1035HT - Power Cleaning 1500 to 1750 PSI



Part Number	I. D.		Max. O. D.		Max. Working Pressure		Min. Bend Radius		Weight		Crimp Fitting		80C Crimp Die
	inch	mm	inch	mm	wpsi	MPa	inch	mm	lbs/ft	kg/m	series	pg	crimp die
#													
hose	inch	mm	inch	mm	wpsi	MPa	inch	mm	lbs/ft	kg/m	series	pg	crimp die
1035HT-3	3/16	5	0.43	11	2000	13.8	3/4	19.1	.043	.06	55	53-77	P03
1035HT-4	1/4	6	0.51	13	1750	12.1	1-1/2	38.1	.057	.08	55	53-77	P04
1035HT-6	3/8	10	0.65	17	1500	10.4	2	50.8	.086	.13	55	53-77	P06

*HBR (Hose Bend Restrictor) suggested for carpet cleaning applications. See hose guard in Hose Accessories section.

Min. Burst Pressure is 4x Max. Working Pressure

Tube: Nylon

Reinforcement: Fiber

Cover: Urethane, perforated

Cover Color: Yellow

Temperature Range: -40°F to +230°F

-40°C to +110°C

Vacuum Rating: 28 inch Hg

(Delta) Working Length @ Rated WPSI: ±2% Max.

Applications/Markets:

Water applications

Carpet cleaning

Note: No chlorinated solvents should be used

Special Features:

Optional colors

Non-marring

Broad temperature range

Note: The above hose(s) are not intended for use in static discharge applications; i.e., airless paint spray.

Twin-Line and Multi-Line Hose Constructions

Parflex Twin-Line consists of two identical hoses permanently joined the entire length, offering a compact system for easy installation and smooth operation.

Parflex Multi-Line consists of two or more hoses in various combinations of sizes and types.

Successful Applications:

- Lift Trucks
- Hydraulic Cranes
- Aerial Lifts
- Limited to a max width of 10" & up to 10 hoses.

Separating Bonded Hoses:

For separating instructions and tooling see: Twin/Multi-Line Separation Instructions on page 237.

Other hose and hose/tubing configurations available. Contact factory for details.



Orange Cover Non-Conductive

Single Hose Part Number	Two Hoses Bonded Together
#	#
540N-4	540N-4-4
540N-5	540N-5-5
540N-6	540N-6-6
540N-8	540N-8-8

Single Hose Part Number	Two Hoses Bonded Together
#	#
518C-4	518C-4-4
518C-5	518C-5-5
518C-6	518C-6-6
518C-8	518C-8-8

Hose Bundles, Harnesses, Pre-formed Hoses

- Parflex hose bundles are designed for compact size, but optimal performance.
- Parflex harnesses are designed for customer's application to eliminate scrap, reduce part numbers and streamline installation.
- Parflex pre-formed hoses are designed to a customer's application, often replacing expensive metal hoses or adapters in tight spaces.

* ALL ARE CUSTOM-DESIGNED TO CUSTOMER NEED. CONTACT FACTORY FOR DETAILS.





Retractable Coiled Hose

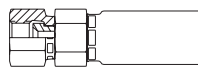
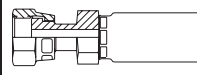

540N -3, -4, -5, -6, -8
520N -3, -4, -5
1035HT -4, -6
580N/588N -4, -6, -8

Parflex retractable coiled hose is designed to meet a customer's unique application needs. Contact factory for details.

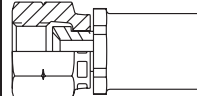
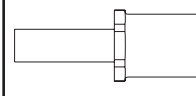

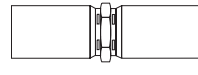
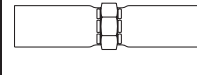
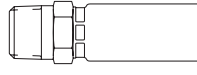
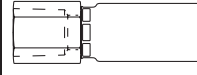
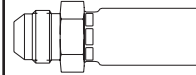
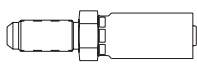
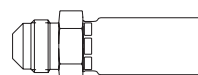
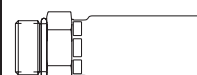
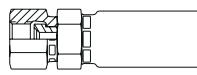
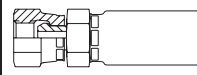
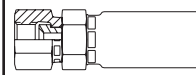
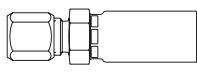
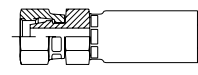
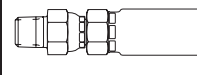
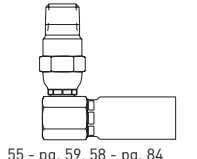
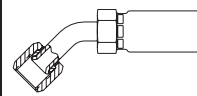
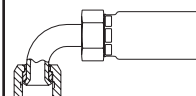
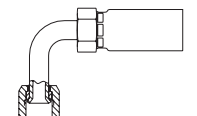
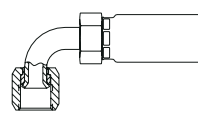
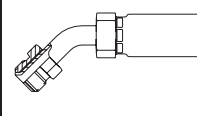
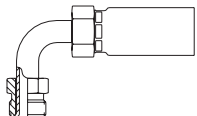
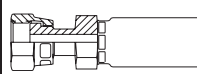
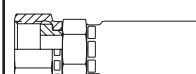
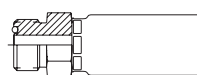
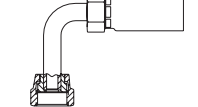
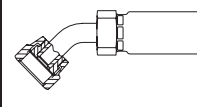
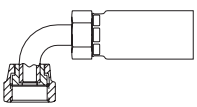
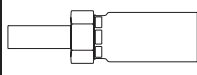
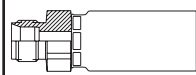
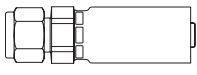
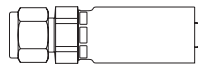
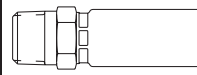
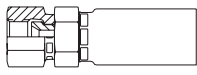
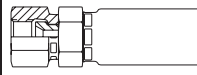
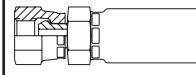
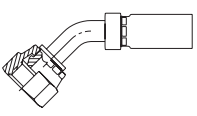
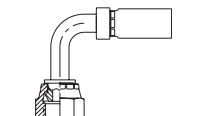
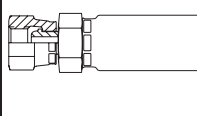
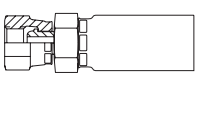
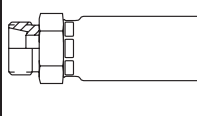
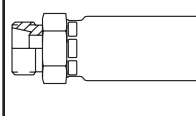
Permanent Hose Fittings					
<p>LV Series Hose Fittings</p> 	<p>106 JIC) 37° Swivel</p>  <p>LV - pg. 41</p>	<p>1JS Seal-Lok™ Straight</p>  <p>LV - pg. 41</p>	<p>MS Series Hose Fittings</p> 	<p>108 SAE 45° Swivel (Brass)</p>  <p>MS - pg. 42</p>	<p>134 Straight Tube (Brass)</p>  <p>MS - pg. 42</p>
<p>55, 58, 58H, Hose Fittings</p> 	<p>158 Permanent Hose Splicer</p>  <p>58 - pg. 43</p>	<p>155 Permanent Hose Splicer</p>  <p>55 - pg. 43</p>	<p>101 Male Taper Pipe Rigid</p>  <p>55, 57 - pg. 53, 58/58H - pg. 78</p>	<p>102 Female Taper Pipe Rigid</p>  <p>55 - pg. 53, 58 - pg. 78</p>	<p>103 Male (JIC) 37°</p>  <p>55 - pg. 54, 58 - pg. 79</p>
<p>13E Male (JIC) 37° Long</p>  <p>55 - pg. 54, 58 - pg. 79</p>	<p>104 Male SAE 45°</p>  <p>55 - pg. 55, 58 - pg. 80</p>	<p>105 Straight Thread O-Ring</p>  <p>55 - pg. 55, 58 - pg. 80</p>	<p>106 SAE (JIC) 37° Swivel</p>  <p>55, 57 - pg. 56, 58/58H - pg. 81</p>	<p>107 Female Pipe Swivel</p>  <p>55 - pg. 57, 58 - pg. 82</p>	<p>108 SAE 45° Swivel</p>  <p>55 - pg. 57, 58 - pg. 82</p>
<p>111 Ferrul-Fix</p>  <p>55 - pg. 58, 58 - pg. 83</p>	<p>112 SAE Flareless Swivel</p>  <p>55 - pg. 58, 58 - pg. 83</p>	<p>113 Male Pipe Swivel</p>  <p>55, 57 - pg. 59, 58/58H - pg. 84</p>	<p>11L Male Pipe Swivel 90° Elbow</p>  <p>55 - pg. 59, 58 - pg. 84</p>	<p>137 SAE (JIC) 37° Swivel 45° Elbow</p>  <p>55, 57 - pg. 60, 58/58H - pg. 85</p>	<p>139 Female SAE (JIC) 37° Swivel 90° Elbow</p>  <p>55, 57 - pg. 61, 58/58H - pg. 86</p>
<p>141 Female SAE (JIC) 37° Swivel 90° Long Elbow</p>  <p>55 - pg. 62, 58 - pg. 88</p>	<p>1L9 Female SAE (JIC) 37° Swivel 90° Elbow Special</p>  <p>55 - pg. 63, 58 - pg. 87</p>	<p>167 SAE Male Inverted Swivel 45° Elbow</p>  <p>55 - pg. 63, 58 - pg. 88</p>	<p>169 SAE Male Inverted Swivel 90° Elbow</p>  <p>55 - pg. 64, 58 - pg. 89</p>	<p>1JS Seal-Lok™ Straight</p>  <p>55, 57 - pg. 64, 58/58H - pg. 89</p>	<p>1JC Seal-Lok™ Straight-Short</p>  <p>55, 57 - pg. 65, 58/58H - pg. 90</p>
<p>1J0 Male Seal-Lok™ - Rigid Straight (with O-Ring)</p>  <p>55 - pg. 65, 58 - pg. 92</p>	<p>1J1 Seal-Lok™ 90° Elbow (Long)</p>  <p>55, 57 - pg. 66, 58/58H - pg. 91</p>	<p>1J7 Seal-Lok™ 45° Elbow</p>  <p>55, 57 - pg. 67, 58/58H - pg. 91</p>	<p>1J9 Seal-Lok™ 90° Elbow</p>  <p>55, 57 - pg. 67, 58/58H - pg. 92</p>	<p>1TU Universal Tube Stub End</p>  <p>55 - pg. 68, 58 - pg. 93</p>	<p>1AL A-LOK® Compression (without Nut and Ferrules)</p>  <p>55N - pg. 68, 58N - pg. 93</p>
<p>1AL A-LOK® Compression (with Nut and Ferrules)</p>  <p>55 - pg. 69, 58 - pg. 94</p>	<p>1P6 CPI Compression (with Nut and Ferrule)</p>  <p>55 - pg. 69, 58 - pg. 94</p>	<p>1UT Male (JIS)/BSPT</p>  <p>55 - pg. 70, 58 - pg. 95</p>	<p>1FU (JIS)/BSP 30° Flare Female Swivel</p>  <p>55 - pg. 70, 58 - pg. 95</p>	<p>1MU (JIS) Metric 30° Flare Female Swivel</p>  <p>55 - pg. 71, 58 - pg. 96</p>	<p>1GU (JIS)/BSP 60° Cone Female Swivel</p>  <p>55 - pg. 71, 58 - pg. 96</p>
<p>1G1 (JIS)/BSP 60° Cone Female Swivel 45° Elbow</p>  <p>55 - pg. 72, 58 - pg. 97</p>	<p>1G2 (JIS)/BSP 60° Cone Female Swivel 90° Elbow</p>  <p>55 - pg. 72, 58 - pg. 97</p>	<p>1C6 Metric Swivel DIN 20078 Heavy Series (w/o O-Ring)</p>  <p>55 - pg. 73, 58 - pg. 98</p>	<p>1C9 Metric Swivel DIN 20078 Heavy Series (w O-Ring)</p>  <p>55 - pg. 73, 58 - pg. 98</p>	<p>1D0 Male Stud Din 20078 Light Series</p>  <p>55 - pg. 73, 58 - pg. 98</p>	<p>1D2 Male Stud DIN 20078 Heavy Series</p>  <p>55 - pg. 74, 58 - pg. 99</p>

PTFE
Hose &
Fittings

Thermoplastic
Tubing

Coiled Air Hose,
Fittings
& Accessories

Truck (Fleet)
Products

Tooling &
Equipment

Hose
Accessories

Technical &
Design
Information

Approvals &
Guides

Alphanumeric
Index

PTFE Hose & Fittings

Thermoplastic Tubing

Coiled Air Hose, Fittings & Accessories

Truck (Fleet) Products

Tooling & Equipment









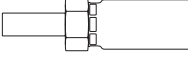

Hose Accessories

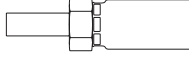
Technical & Design Information

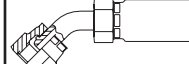
Approvals & Guides

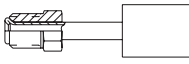
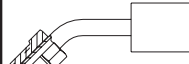
Alphanumeric Index

Permanent Hose Fittings

<p>11D Metric Standpipe Light Series</p>  <p>55 - pg. 74, 58 - pg. 99</p>	<p>1D9 Male BSP</p>  <p>55 - pg. 75, 58 - pg. 101</p>	<p>13D Metric Standpipe Heavy Series</p>  <p>55 - pg. 75, 58 - pg. 102</p>	<p>192 BSP Swivel Female, Ballnose</p>  <p>55 - pg. 76, 58 - pg. 100</p>	<p>1B1 BSP Female Swivel 45° Elbow, Ballnose</p>  <p>55 - pg. 76, 58 - pg. 100</p>	<p>1B2 BSP Female Swivel 90° Elbow, Ballnose</p>  <p>55 - pg. 77, 58 - pg. 101</p>
<p>92 Series Hose Fittings</p>	<p>111 Ferrul-Fix</p>  <p>92 - pg. 103</p>	<p>128 SAE Male Inverted Swivel Straight</p>  <p>92 - pg. 103</p>	<p>167 SAE Male Inverted Swivel 45° Elbow</p>  <p>92 - pg. 104</p>	<p>169 SAE Male Inverted Swivel 90° Elbow</p>  <p>92 - pg. 104</p>	<p>SQ Series Hose Fittings</p>
<p>SQ Mender</p>  <p>SQ - pg. 110</p>	<p>101</p>  <p>SQ - pg. 110</p>				

Please refer to the Hose Fitting Thread Guide.

Note: Fittings 43, HY (pages 112-128) and 82 are all Hose Product Division Fittings and must be purchased through HPD. HY fittings have been added to this catalog for reference purposes only.

Note: Brass or stainless steel fittings are recommended for use with water-based fluids to avoid potential corrosion.

Field Attachable Hose Fittings

<p>51 Series Standard & Metric Field Attachable</p>	<p>208 SAE 45° Swivel (Brass)</p> <p>MS - pg. 42</p>	<p>201 Male Taper Pipe Rigid</p> <p>51 - pg. 44</p>	<p>203 Male (JIC) 37°</p> <p>51 - pg. 44</p>	<p>206 SAE (JIC) 37° Swivel</p> <p>51 - pg. 45</p>	<p>208 SAE 45° Swivel</p> <p>51 - pg. 45</p>	
	<p>211 Ferrul-Fix (Nut and Sleeve Included)</p> <p>51 - pg. 46</p>	<p>239 (JIC) 37° Swivel 90° Elbow</p> <p>51 - pg. 46</p>	<p>2C3 Swivel DIN 20078 Light Series</p> <p>51 - pg. 47</p>	<p>2C4 Swivel DIN 20078 Light Series 45° Elbow</p> <p>51 - pg. 47</p>	<p>2C5 Swivel DIN 20078 Light Series 90° Elbow</p> <p>51 - pg. 48</p>	<p>2C6 Metric Swivel DIN 20078 Heavy Series (w/o O-Ring)</p> <p>51 - pg. 48</p>
	<p>2C9 Metric Swivel DIN 20078 Heavy Series (w/ O-Ring)</p> <p>51 - pg. 48</p>	<p>2D0 Stud DIN 20078 Light Series</p> <p>51 - pg. 49</p>	<p>2D2 Stud DIN 20078 Heavy Series</p> <p>51 - pg. 49</p>	<p>21D Standpipe Light Series</p> <p>51 - pg. 50</p>	<p>23D Standpipe Heavy Series</p> <p>51 - pg. 50</p>	<p>2D9 BSP Male</p> <p>51 - pg. 51</p>
	<p>292 BSP Swivel Female, Ballnose</p> <p>51 - pg. 51</p>	<p>2B1 BSP Swivel Female 45° Elbow, Ballnose</p> <p>51 - pg. 52</p>	<p>2B2 BSP Swivel Female 90° Elbow, Ballnose</p> <p>51 - pg. 52</p>	<p>BA Series Hose Fittings</p>	<p>201 Male NPTF Rigid Straight</p> <p>BA - pg. 105</p>	<p>203 Male JIC 37° Rigid Straight</p> <p>BA - pg. 105</p>
	<p>206 Female JIC 37° Swivel Straight</p> <p>BA - pg. 106</p>	<p>208 Female SAE 45° Swivel Straight</p> <p>BA - pg. 106</p>	<p>237 Female JIC 37° Swivel 45° Elbow Short Drop</p> <p>BA - pg. 106</p>		<p>239 Female JIC 37° Swivel 90° Elbow Short Drop</p> <p>BA - pg. 107</p>	<p>241 Female JIC 37° Swivel 90° Elbow Long Drop</p> <p>BA - pg. 107</p>

Please refer to the Hose Fitting Thread Guide.

Note: Fittings 43, HY (pages 112-128) and 82 are all Hose Product Division Fittings and must be purchased through HPD. HY fittings have been added to this catalog for reference only purposes.

Note: All 51 series are sold in component form

*** 51 series field attachable couplings are not intended for use on hose that has previously been in service.**

PTFE
Hose &
Fittings

Thermoplastic
Tubing

Coiled Air Hose,
Fittings
& Accessories

Truck (Fleet)
Products

Tooling &
Equipment

Hose
Accessories

Technical &
Design
Information

Approvals &
Guides

Alphanumeric
Index

Description	End Code
Male Pipe Thread NPTF	01
Female Pipe Thread NPTF	02
Male SAE (JIC) 37° flare	03
Male SAE 45° Flare	04
Male straight Thread with O-Ring	05
Female SAE (JIC) 37° Swivel	06
Female Pipe Swivel - NPSM	07
Female SAE 45° Swivel	08
Ferrul-Fix (SAE Flareless)	11
SAE Flareless Swivel	12
Male Pipe NPTF Swivel	13
SAE Flange Head Straight (Code 61) - Standard Pressure	15
SAE Flange Head - 22-1/2° Elbow (Code 61) - Standard Pressure	16
SAE Flange Head - 45° Elbow (Code 61) - Standard Pressure	17
SAE Flange Head - 67-1/2° Elbow (Code 61) - Standard Pressure	18
SAE Flange Head - 90° Elbow (Code 61) - Standard Pressure	19
Male Pipe Swivel NPTF 90° Elbow	1L
Male Inverted Swivel-STR	28
Straight Tube, Inch Sized	34
Female SAE (JIC) 37° Swivel - 45° Elbow	37
Female SAE (JIC) 37° Swivel - 90° Elbow	39
Female SAE (JIC) 37° Swivel - 90° Long Elbow	41
SAE Compression Air Brake	61
SAE Male Inverted Swivel - 45° Elbow	67
SAE Male Inverted Swivel - 90° Elbow	69
SAE Male Inverted Swivel - 90° Long Elbow	71
SAE 45° Female Swivel - 45° Elbow	77
SAE 45° Female Swivel - 90° Elbow	79
SAE 45° Female Swivel - 90° Long Elbow	81
Female Seal-Lok Swivel-STR-Short	JC
Female JIS/BSP 30° Flare-Swivel	FU
Metric Female JIS 30° Flare-Swivel	MU
Male JIS/BSP Taper Pipe-Rigid-STR (60° cone)	UT
Male Seal-Lok-Rigid-STR (W/ peroxide cured O-Ring & captive O-Ring groove)	J0
Female JIS/BSP Parallel Pipe-Swivel (60° cone)	GU
Female JIS/BSPP - Swivel 45° Elbow (60° cone)	G1
Female JIS/BSPP - Swivel 90° Elbow (60° cone)	G2
ANSI B16.5 Flange	4K
Seal-Lok (O-Ring Face Seal), Female STR	JS
Seal-Lok (O-Ring Face Seal), Female 45° Elbow	J7
Seal-Lok (O-Ring Face Seal), Female 90° Elbow	J9
Seal-Lok (O-Ring Face Seal), Female 90° Long Elbow	J1
Female SAE (JIC) 37° Swivel - 90° Elbow Special Drop	L9
Metric Swivel Female DIN 20078 Light Series	C3
Metric Swivel Female DIN 20078 Light Series - 45° Elbow	C4
Metric Swivel Female DIN 20078 Light Series - 90° Elbow	C5
Metric Swivel Female DIN 20078 Heavy Series W/O-Ring	C6
Metric Swivel Female DIN 20078 Heavy Series W/O-Ring	C9
Metric Male Stud DIN 20078 Light Series	D0
Metric Male Stud DIN 20078 Heavy Series	D2
Metric Standpipe - Light Series	1D
Metric Standpipe - Heavy Series	3D
Male BSPP	D9
BSP Swivel Female	92
BSP Swivel Female - 45° Elbow	B1
BSP Swivel Female - 90° Elbow	B2
Metric French Swivel Female	F9
Metric French Male Stud - GAS Series	FG
Metric French Swivel Female - GAS Series	F4
Metric French Standpipe - GAS Series	GE
Universal Tube Stub End	TU
Ultra Seal	QI
A-LOK® Compression	AL
CPI Compression	P6
Sanitary Flange	FN
Mini Sanitary Flange	FV
Male VacuSeal	HV
Female VacuSeal	VH
Male (JIC) 37° Long	3E

Contact Parflex Division for non-standard end configurations.

Hydraulic & Pneumatic Hose & Fit.

PTFE Hose & Fittings

Thermoplastic Tubing

Coiled Air Hose, Fittings & Accessories

Truck (Fleet) Products

Tooling & Equipment

Hose Accessories

Technical & Design Information

Approvals & Guides

Alphanumeric Index



106LV (JIC) 37° Swivel

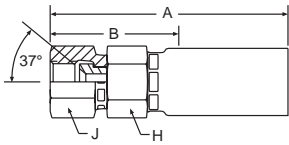

LV Series Permanent

Steel Part Number	B	C	Thread Size	Tube O. D.	Hose I.D.	A		Cutoff Allow. B		H Hex	J Hex	Pusher Number
						inch	mm	inch	mm	inch	inch	
#												
Hose Fitting				inch	inch	inch	mm	inch	mm	inch	inch	
106LV-4-3 (+)	+	+	7/16-20	1/4	3/16	1.90	48	0.94	24	9/16	9/16	PUF 017
106LV-12-12	+	+	1-1/16-12	3/4	3/4	4.12	105	1.81	46	1-1/8	1-1/4	PUF 008
106LV-16-16	+		1-5/16-12	1	1	4.77	121	1.72	44	1-3/8	1-1/2	PUF 009

*316 Stainless steel nipple, nut and shell

When swaging stainless steel fittings, lubricate dies with Parker-type 702 oil.

(+) Non Standard. See page ii for information on non-standard products.



208MS SAE 45° Swivel (Brass)

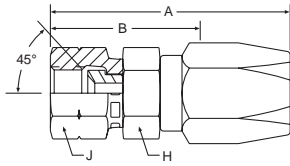

MS Series Field Attachable

Brass Part Number	B	C	Thread Size	Tube O. D.	Hose I.D.	A		Cutoff Allow. B		H Hex	J Hex
						inch	mm	inch	mm		
#											
Hose Fitting				inch	inch	inch	mm	inch	mm	inch	inch
208MS-6-5 (+)		+	5/8-18	3/8	5/16	2.06	52	1 5/16	33	5/8	13/16
208MS-6-6 (+)		+	5/8-18	3/8	3/8	2.37	60	1 7/16	37	5/8	13/16

108MS SAE 45° Swivel (Brass)

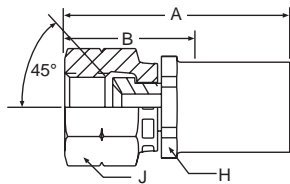

MS Series Permanent

Brass Part Number	B	C	Thread Size	Tube O. D.	Hose I.D.	A		Cutoff Allow. B		H Hex	J Hex	Pusher Number
						inch	mm	inch	mm			
#												
Hose Fitting				inch	inch	inch	mm	inch	mm	inch	inch	
108MS-6-5 (+)		+	5/8-18	3/8	5/16	1.68	43	1	25	5/8	13/16	PUF 027
108MS-6-6 (+)		+	5/8-18	3/8	3/8	1.68	43	1	25	3/4	13/16	PUF 027

134MS Straight Tube (Brass)

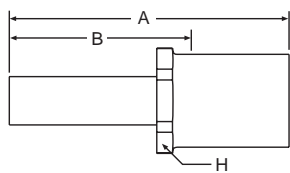

MS Series Permanent

Brass Part Number	B	C	Tube O. D.	Hose I.D.	A		Cutoff Allow. B		H Hex	Pusher Number
					inch	mm	inch	mm		
#										
Hose Fitting			inch	inch	inch	mm	inch	mm	inch	
134MS-6-5 (+)		+	3/8	5/16	2.00	51	1.38	35	5/8	PUM 018
134MS-6-6 (+)		+	3/8	3/8	2.00	51	1.38	35	3/4	PUM 018

(+) Non Standard. See page ii for information on non-standard products.

15858 Permanent Hose Splicer

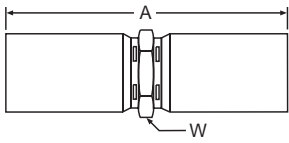

58 Series Permanent

Steel Part Number	C	Hose I.D.	A		W Hex
#					
Hose Fitting		inch	inch	mm	inch
15858-4-4 (+)	+	1/4	3.25	83	11/16
15858-5-5 (+)	+	5/16	3.25	83	3/4
15858-6-6 (+)	+	3/8	3.62	92	13/16
15858-8-8 (+)	+	1/2	4	102	1
15858-12-12 (+)	+	3/4	4.5	114	1-5/16
15858-16-16	+	1	5.54	141	1-9/16

15555 Permanent Hose Splicer

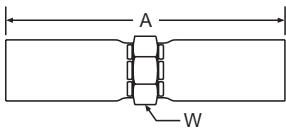

55 Series Permanent

Steel Part Number	C	Hose I.D.	A		W Hex
#					
Hose Fitting		inch	inch	mm	inch
15555-3-3 (+)	+	3/16	3.00	76	5/8
15555-4-4	+	1/4	3.25	83	11/16
15555-5-5 (+)	+	5/16	3.25	83	3/4
15555-6-6	+	3/8	3.62	92	13/16
15555-8-8	+	1/2	4.00	102	1
15555-12-12	+	3/4	4.50	114	1-5/16
15555-16-16	+	1	5.54	141	1-9/16

(+) Non Standard. See page ii for information on non-standard products.

20151 Male Taper Pipe Rigid

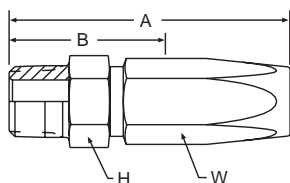

51 Series Field Attachable

Steel Part Number	B	C	NPTF Pipe Thread	Hose I.D.	A		Cutoff Allow. B		H Hex	W Hex
					inch	mm	inch	mm		
#										
Hose Fitting				inch	inch	mm	inch	mm	inch	inch
20151-2-3	+	+	1/8-27	3/16	1.71	43	1	25	7/16	5/8
20151-4-3	+	+	1/4-18	3/16	1.90	48	1.13	29	9/16	5/8
20151-2-4	+	+	1/8-27	1/4	1.90	48	1	25	1/2	5/8
20151-4-4	+	+	1/4-18	1/4	2.08	53	1.19	30	9/16	5/8
20151-4-5	+	+	1/4-18	5/16	2.17	55	1.44	37	9/16	3/4
20151-6-5	+	+	3/8-18	5/16	2.17	55	1.44	37	3/4	3/4
20151-4-6	+	+	1/4-18	3/8	2.61	66	1.44	37	3/4	7/8
20151-6-6	+		3/8-18	3/8	2.61	66	1.44	37	3/4	7/8
20151-8-6	+	+	1/2-14	3/8	2.80	71	1.56	40	7/8	7/8
20151-6-8	+	+	3/8-18	1/2	2.99	76	1.50	38	7/8	1-1/16
20151-8-8	+	+	1/2-14	1/2	3.17	81	1.69	43	7/8	1-1/16
20151-12-12	+	+	3/4-14	3/4	3.42	87	1.75	44	1-1/8	1-3/8
20151-16-16	+	+	1-11-1/2	1	3.74	95	2.25	57	1-3/8	1-11/16

20351 Male (JIC) 37°

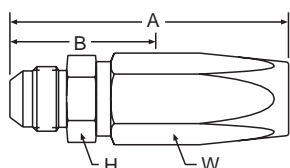

51 Series Field Attachable

Steel Part Number	B	C	Thread Size	Tube O. D.	Hose I.D.	A		Cutoff Allow. B		H Hex	W Hex
						inch	mm	inch	mm		
#											
Hose Fitting				inch	inch	inch	mm	inch	mm	inch	inch
20351-4-3	+	+	7/16-20	1/4	3/16	1.88	48	1.13	29	1/2	5/8
20351-5-4	+	+	1/2-20	5/16	1/4	2.06	52	1.13	29	9/16	5/8
20351-6-5	+	+	9/16-18	3/8	5/16	2.16	55	1.31	33	5/8	3/4
20351-6-6	+	+	9/16-18	3/8	3/8	2.61	66	1.44	37	3/4	7/8
20351-8-6	+	+	3/4--16	1/2	3/8	2.71	69	1.44	37	13/16	7/8
20351-8-8	+	+	3/4-16	1/2	1/2	3.08	78	1.63	41	7/8	7/8

*** 51 series field attachable couplings are not intended for use on hose that has previously been in service.**

(+) Non Standard. See page ii for information on non-standard products.



PTFE Hose & Fittings

Thermoplastic Tubing

Coiled Air Hose, Fittings & Accessories

Truck (Fleet) Products

Tooling & Equipment

Hose Accessories

Technical & Design Information

Approvals & Guides

Alphanumeric Index

20651 SAE (JIC) 37° Swivel

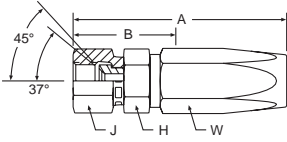

51 Series Field Attachable

Steel Part Number	B	C	Thread Size	Tube O. D.	Hose I.D.	A		Cutoff Allow. B		H, J Hex	W Hex
						inch	mm	inch	mm		
#											
Hose Fitting				inch	inch	inch	mm	inch	mm	inch	inch
20651-4-3	+	+	7/16-20	1/4	3/16	1.99	51	1.25	32	9/16	5/8
20651-4-4	+	+	7/16-20	1/4	1/4	2.18	55	1.25	32	9/16	5/8
20651-5-4	+	+	1/2-20	5/16	1/4	2.24	57	1.44	37	5/8	5/8
20651-6-4	+	+	9/16-18	3/8	1/4	2.34	59	1.44	37	11/16	5/8
20651-6-5	+	+	9/16-18	3/8	5/16	2.37	60	1.50	38	11/16	3/4
20651-6-6		+	9/16-18	3/8	3/8	2.74	70	1.44	37	11/16	7/8
20651A-6-6	+	+	9/16-18	3/8	3/8	2.74	70	1.44	37	11/16	7/8
20651-8-6	+	+	3/4-16	1/2	3/8	2.88	73	1.63	41	7/8	7/8
20651-8-8	+	+	3/4-16	1/2	1/2	3.25	83	1.75	44	7/8	1-1/16
20651A-8-8	+	+	3/4-16	1/2	1/2	3.25	83	1.75	44	7/8	1-1/16
20651-10-8	+	+	7/8-14	5/8	1/2	3.37	86	1.88	48	1	1-1/16
20651-12-12	+	+	1-1/16-12	3/4	3/4	3.75	95	2.13	54	1-1/4	1-3/8
20651-16-16	+	+	1-5/16-12	1	1	3.93	100	2.44	62	1-1/2	1-11/16

20851 SAE 45° Swivel

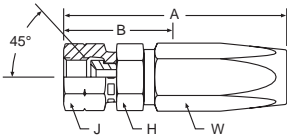

51 Series Field Attachable

Steel Part Number	B	C	Thread Size	Tube O. D.	Hose I.D.	A		Cutoff Allow. B		H, J Hex	W Hex
						inch	mm	inch	mm		
#											
Hose Fitting				inch	inch	inch	mm	inch	mm	inch	inch
20851-6-6	+	+	5/8-18	3/8	3/8	2.82	72	1.56	40	3/4	7/8

*** 51 series field attachable couplings are not intended for use on hose that has previously been in service.**

(+) Non Standard. See page ii for information on non-standard products.



21151 Ferrul-Fix

(Nut and Sleeve Included)

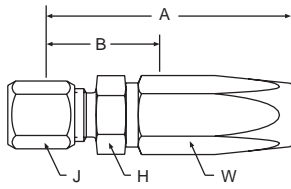

51 Series Field Attachable

Steel Part Number	B	C	Thread Size	Tube O. D.	Hose I.D.	A		Cutoff Allow. B		H Hex	J Hex	W Hex
						inch	mm	inch	mm			
#												
Hose Fitting				inch	inch	inch	mm	inch	mm	inch	inch	inch
21151-6-6 (+)	+	+	9/16-18	3/8	3/8	2.50	64	1.25	32	3/4	11/16	7/8
21151-8-8	+	+	3/4-16	1/2	1/2	2.96	75	1.50	38	7/8	7/8	1-1/16

"Ferrul-Fix" affords salvaging of bent tube section of combination tube-hose assemblies and quick, easy repair on the job.

Note: Nut Part Number is 111-size
Sleeve Part Number is 110-size

23951 (JIC) 37° Swivel 90° Elbow

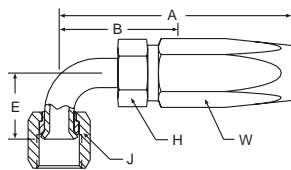

51 Series Field Attachable

Steel Part Number	B	C	Thread Size	Tube O. D.	Hose I.D.	A		Cutoff Allow. B		E	H Hex	J Hex	W Hex	
						inch	mm	inch	mm					
#														
Hose Fitting				inch	inch	inch	mm	inch	mm	inch	mm	inch	inch	
23951-4-3	+	+	7/18-20	1/4	3/16	1.77	45	1	25	0.68	17	3/4	5/8	9/16
23951-6-6	+	+	9/16-18	3/8	3/8	2.70	69	1.44	37	0.85	22	9/16	7/8	11/16
23951-8-6	+	+	3/4-16	1/2	3/8	2.90	74	1.63	41	1.09	28	11/16	7/5	7/8

*** 51 series field attachable couplings are not intended for use on hose that has previously been in service.**

(+) Non Standard. See page ii for information on non-standard products.

2C351 Swivel DIN 20078 Light Series

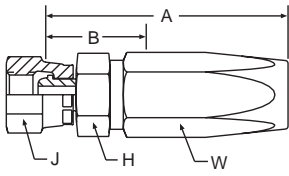

51 Series Field Attachable

Steel Part Number	Thread Size	Hose I.D.	A		Cutoff Allow. B		H Hex	J Hex	W Hex
			inch	mm	inch	mm	mm	mm	mm
#									
Hose Fitting		inch	inch	mm	inch	mm	mm	mm	mm
2C351-6-3 (+)	M12 X 1,5	3/16	1.69	43	0.94	24	-	14	16
2C351-8-4 (+)	M14 X 1,5	1/4	1.85	47	0.98	25	-	17	17
2C351-10-5 (+)	M16 X 1,5	5/16	1.89	48	0.87	22	-	19	19
2C351-10-6	M16 X 1,5	3/8	2.48	63	1.38	35	17	19	22
2C351-12-6	M18 X 1,5	3/8	2.48	63	1.34	34	19	22	22
2C351-15-8	M22 X 1,5	1/2	2.91	74	1.61	41	22	27	27
2C351-18-12	M26 X 1,5	3/4	3.07	78	1.46	37	27	32	35
2C351-22-12	M30 X 2	3/4	3.23	82	1.61	41	30	36	35
2C351-28-16 (+)	M36 X 2	1	3.86	98	2.05	52	36	46	43

2C451 Swivel DIN 20078 Light Series 45° Elbow

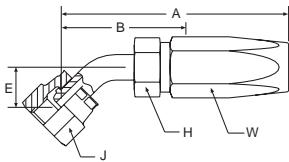

51 Series Field Attachable

Steel Part Number	Thread Size	Hose I.D.	A		Cutoff Allow. B		E		H Hex	J Hex	W Hex
			inch	mm	inch	mm	inch	mm	mm	mm	mm
#											
Hose Fitting		inch	inch	mm	inch	mm	inch	mm	mm	mm	mm
2C451-6-3 (+)	M12 X 1,5	3/16	2.36	60	1.26	32	0.51	13	14	17	16
2C451-8-4 (+)	M14 X 1,5	1/4	2.32	59	1.57	40	0.51	13	14	17	17
2C451-10-5 (+)	M16 X 1,5	5/16	2.76	70	1.61	41	0.63	16	17	19	19
2C451-12-6	M18 X 1,5	3/8	3.50	89	2.28	58	0.75	19	17	22	22
2C451-18-12 (+)	M26 X 1,5	3/4	4.57	116	2.95	75	1.02	26	27	36	35
2C451-22-12 (+)	M30 X 2	3/4	4.69	119	3.11	79	1.14	29	30	36	35
2C451-28-16 (+)	M36 X 2	1	5.00	127	3.23	82	1.22	31	32	46	43

*** 51 series field attachable couplings are not intended for use on hose that has previously been in service.**

(+) Non Standard. See page ii for information on non-standard products.



Hydraulic & Pneumatic Hose & Fit.

PTFE Hose & Fittings

Thermoplastic Tubing

Coiled Air Hose, Fittings & Accessories

Truck (Fleet) Products

Tooling & Equipment

Hose Accessories

Technical & Design Information

Approvals & Guides

Alphanumeric Index

2C551 Swivel DIN 20078 Light Series 90° Elbow

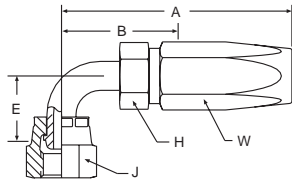

51 Series Field Attachable

Steel Part Number	Thread Size	Hose I.D.	A		Cutoff Allow. B		E		H Hex	J Hex	W Hex
			inch	mm	inch	mm	inch	mm	mm	mm	mm
#											
Hose Fitting		inch	inch	mm	inch	mm	inch	mm	mm	mm	mm
2C551-6-3 (+)	M12 X 1,5	3/16	2.17	55	1.30	33	1.02	26	14	17	16
2C551-8-4 (+)	M14 X 1,5	1/4	2.09	53	1.34	34	0.98	25	14	17	17
2C551-10-5 (+)	M16 X 1,5	5/16	2.60	66	1.57	40	1.26	32	17	19	19
2C551-10-6 (+)	M16 X 1,5	3/8	2.95	75	1.85	47	1.38	35	14	19	22
2C551-15-8	M22 X 1,5	1/2	3.50	89	2.09	53	1.65	42	22	27	27
2C551-18-12 (+)	M26 X 1,5	3/4	2.76	70	2.76	70	2.32	59	27	36	35
2C551-22-12 (+)	M30 X 2	3/4	2.87	73	2.87	73	2.52	64	30	36	35
2C551-28-16 (+)	M36 X 2	1	2.95	75	2.95	75	2.64	67	32	46	43

2C651 Metric Swivel DIN 20078 Heavy Series (Without O-Ring) 2C951 (With O-Ring)

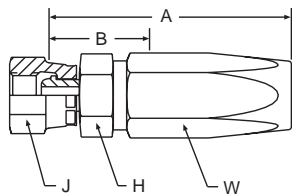

51 Series Field Attachable

Steel Part Number	Thread Size	Hose I.D.	A		Cutoff Allow. B		H Hex	J Hex	W Hex
			inch	mm	inch	mm	mm	mm	mm
#									
Hose Fitting		inch	inch	mm	inch	mm	mm	mm	mm
2C651-8-3 (+)	M16 X 1,5	3/16	1.93	49	1.10	28	17	19	16
2C651-10-4 (+)	M18 X 1,5	1/4	2.40	61	1.42	36	17	22	17
2C651-12-5 (+)	M20 X 1,5	5/16	2.40	61	1.38	35	19	24	29
2C651-12-6 (+)	M20 X 1,5	3/8	2.52	64	1.42	36	19	24	22
2C651-14-6 (+)	M22 X 1,5	3/8	2.56	65	1.46	37	22	27	22
2C651-16-8	M24 X 1,5	1/2	2.87	73	1.57	40	24	30	27
2C651-20-12 (+)	M30 X 2	3/4	3.19	81	1.61	41	30	36	35
2C651-25-12 (+)	M36 X 2	3/4	3.19	81	1.57	40	36	46	35
2C651-30-16 (+)	M42 X 2	1	3.70	94	1.89	48	41	50	43

*** 51 series field attachable couplings are not intended for use on hose that has previously been in service.**

(+) Non Standard. See page ii for information on non-standard products.

PTFE Hose & Fittings

Thermoplastic Tubing

Coiled Air Hose, Fittings & Accessories

Truck (Fleet) Products

Tooling & Equipment

Hose Accessories

Technical & Design Information

Approvals & Guides

Alphanumeric Index

2D051 Stud DIN 20078 Light Series

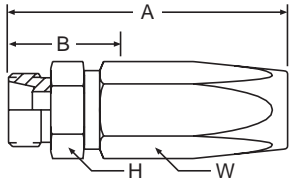

51 Series Field Attachable

Steel Part Number	Thread Size	Tube O.D.	Hose I.D.	A		Cutoff Allow. B		H Hex	W Hex
				inch	mm	inch	mm		
#									
Hose Fitting		mm	inch	inch	mm	inch	mm	mm	mm
2D051-6-3 (+)	M12 X 1,5	6	3/16	1.69	43	0.94	24	14	16
2D051-8-4 (+)	M14 X 1,5	8	1/4	1.81	46	0.98	25	17	17
2D051-10-5 (+)	M16 X 1,5	10	5/16	2.05	52	1.02	26	17	29
2D051-10-6 (+)	M16 X 1,5	10	3/8	2.32	59	1.18	30	17	22
2D051-12-6 (+)	M18 X 1,5	12	3/8	2.32	59	1.18	30	19	22
2D051-15-8	M22 X 1,5	15	1/2	2.60	66	1.34	34	22	27
2D051-18-12 (+)	M26 X 1,5	18	3/4	2.83	72	1.26	32	27	35
2D051-22-12 (+)	M30 X 2	22	3/4	2.95	75	1.38	35	30	35
2D051-28-16 (+)	M36 X 2	28	1	3.31	84	1.50	38	36	43

2D251 Stud DIN 20078 Heavy Series

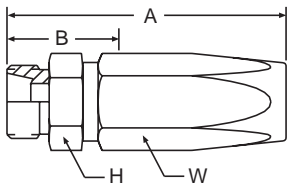

51 Series Field Attachable

Steel Part Number	Thread Size	Tube O.D.	Hose I.D.	A		Cutoff Allow. B		H Hex	W Hex
				inch	mm	inch	mm		
#									
Hose Fitting		mm	inch	inch	mm	inch	mm	mm	mm
2D251-8-3 (+)	M16 X 1,5	8	3/16	1.85	47	1.06	27	17	16
2D251-10-4 (+)	M18 X 1,5	10	1/4	2.09	53	1.10	28	19	17
2D251-12-5 (+)	M20 X 1,5	12	5/16	2.17	55	1.06	27	22	29
2D251-12-6	M20 X 1,5	12	3/8	2.48	63	1.34	34	22	22
2D251-14-6	M22 X 1,5	14	3/8	2.52	64	1.38	35	22	22
2D251-16-8	M24 X 1,5	16	1/2	2.83	72	1.57	40	24	27
2D251-20-12 (+)	M30 X 2	20	3/4	3.15	80	1.57	40	30	35
2D251-25-12 (+)	M36 X 2	25	3/4	3.31	84	1.73	44	36	35
2D251-30-16 (+)	M42 X 2	30	1	3.78	96	1.97	50	46	43

* 51 series field attachable couplings are not intended for use on hose that has previously been in service.

(+) Non Standard. See page ii for information on non-standard products.



21D51 Standpipe Light Series

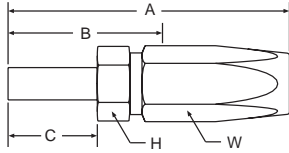

51 Series Field Attachable

Steel Part Number	Tube O.D.	Hose I.D.	A		Cutoff Allow. B		C		H Hex	W Hex
			inch	mm	inch	mm	inch	mm		
#										
Hose Fitting	mm	inch	inch	mm	inch	mm	inch	mm	mm	mm
21D51-6-3	6	3/16	2.17	55	1.38	35	0.87	22	17	16
21D51-6-6 (+)	6	3/8	2.64	67	1.26	32	0.71	18	19	22
21D51-8-4 (+)	8	1/4	2.28	58	1.42	36	0.87	22	14	17
21D51-10-5	10	5/16	2.52	64	1.50	38	0.91	23	14	29
21D51-10-6 (+)	10	3/8	2.80	71	1.65	42	0.91	23	17	22
21D51-15-8	15	1/2	3.15	80	1.89	48	0.98	25	19	27
21D51-22-12 (+)	22	3/4	3.46	88	1.89	48	1.10	28	27	35
21D51-28-16 (+)	28	1	4.09	104	2.28	58	1.18	30	32	43

23D51 Standpipe Heavy Series

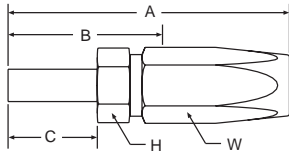

51 Series Field Attachable

Steel Part Number	Tube O.D.	Hose I.D.	A		Cutoff Allow. B		C		H Hex	W Hex
			inch	mm	inch	mm	inch	mm		
#										
Hose Fitting	mm	inch	inch	mm	inch	mm	inch	mm	mm	mm
23D51-8-3 (+)	8 (+)	3/16	2.20	56	1.42	36	0.94	24	14	16
23D51-10-4 (+)	10 (+)	1/4	2.28	58	1.42	36	1.02	26	14	17
23D51-12-5 (+)	12 (+)	5/16	2.56	65	1.54	39	1.02	26	14	29
23D51-12-6 (+)	12	3/8	2.91	74	1.81	46	1.02	26	17	22
23D51-14-6 (+)	14	3/8	3.03	77	1.89	48	1.14	29	17	22
23D51-25-12 (+)	25	3/4	4.17	106	2.56	65	1.58	40	27	35
23D51-30-16 (+)	30	1	4.65	118	2.83	72	1.73	44	32	43

*** 51 series field attachable couplings are not intended for use on hose that has previously been in service.**

(+) Non Standard. See page ii for information on non-standard products.

2D951 BSP Male

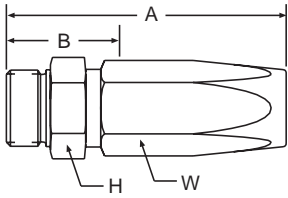

51 Series Field Attachable

Steel Part Number	Thread Size	Hose I.D.	A		Cutoff Allow. B		H Hex	W Hex
			inch	mm	inch	mm	mm	mm
#								
Hose Fitting		inch	inch	mm	inch	mm	mm	mm
2D951-2-3 (+)	PF 1/8-28	3/16	1.73	44	0.94	24	14	16
2D951-4-3 (+)	PF 1/4-19	3/16	1.93	49	1.14	29	19	16
2D951-4-4 (+)	PF 1/4-19	1/4	2.13	54	1.14	29	19	17
2D951-6-5 (+)	PF 3/8-19	5/16	2.28	58	1.18	30	22	19
2D951-6-6	PF 3/8-19	3/8	2.44	62	1.34	34	22	22
2D951-8-8 (+)	PF 1/2-14	1/2	2.87	73	1.61	41	27	27
2D951-12-12	PF 3/4-14	3/4	3.19	81	1.61	41	32	35
2D951-16-16 (+)	PF 1-11	1	3.74	95	1.93	49	41	43

29251 BSP Swivel Female, Ballnose

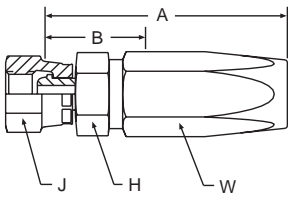

51 Series Field Attachable

Steel Part Number	BSP Thread Size	Hose I.D.	A		Cutoff Allow. B		H Hex	J Hex	W Hex
			inch	mm	inch	mm	mm	mm	mm
#									
Hose Fitting		inch	inch	mm	inch	mm	mm		mm
29251-4-3 (+)	PF 1/4-19	3/16	1.77	45	0.98	25	17	19	16
29251-4-4 (+)	PF 1/4-19	1/4	1.85	47	1.10	28	17	19	17
29251-6-5 (+)	PF 3/8-19	5/16	1.89	48	0.94	24	19	22	19
29251-6-6	PF 3/8-19	3/8	2.48	63	1.38	35	19	22	22
29251-8-8	PF 1/2-14	1/2	1.91	74	1.61	41	27	27	27
29251-12-12 (+)	PF 3/4-14	3/4	3.07	78	1.46	37	36	36	35
29251-16-16 (+)	PF 1-11	1	3.54	90	1.73	44	36	41	43

*** 51 series field attachable couplings are not intended for use on hose that has previously been in service.**

(+) Non Standard. See page ii for information on non-standard products.

2B151 BSP Swivel Female 45° Elbow, Ballnose

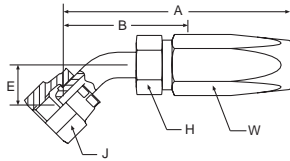

51 Series Field Attachable

Steel Part Number	BSP Thread Size	Tube I.D.	A		Cutoff Allow. B		E		H Hex	J Hex	W Hex
			inch	mm	inch	mm	inch	mm	mm	mm	mm
#											
Hose Fitting		inch	inch	mm	inch	mm	inch	mm	mm		mm
2B151-4-3 (+)	PF 1/4-19	3/16	2.28	58	1.50	38	0.55	14	14	17	16
2B151-4-4 (+)	PF 1/4-19	1/4	2.32	59	1.57	40	0.55	14	14	17	17
2B151-6-5 (+)	PF 3/8-19	5/16	2.76	70	1.76	44	0.55	14	14	19	19
2B151-12-12 (+)	PF 3/4-14	3/4	3.94	100	2.36	60	0.79	20	30	32	35
2B151-16-16 (+)	PF 1-11	1	4.80	122	2.99	76	1.02	26	32	41	43

2B251 BSP Swivel Female 90° Elbow, Ballnose

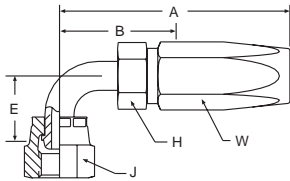

51 Series Field Attachable

Steel Part Number	BSP Thread Size	Tube I.D.	A		Cutoff Allow. B		E		H Hex	J Hex	W Hex
			inch	mm	inch	mm	inch	mm	mm	mm	mm
#											
Hose Fitting		inch	inch	mm	inch	mm	inch	mm	mm		mm
2B251-4-3 (+)	PF 1/4-19	3/16	2.28	58	1.30	33	0.55	14	14	17	16
2B251-4-4 (+)	PF 1/4-19	1/4	2.32	59	1.30	33	1.02	26	14	17	17
2B251-6-5 (+)	PF 3/8-19	5/16	2.60	66	1.57	40	1.34	34	14	19	19
2B251-6-6	PF 3/8-19	3/8	2.95	75	1.73	44	1.22	31	17	19	22
2B251-8-8 (+)	PF 1/2-14	1/2	3.50	89	2.09	53	1.50	38	22	27	27
2B251-12-12 (+)	PF 3/4-14	3/4	4.09	104	2.52	64	1.85	47	30	32	35
2B251-16-16 (+)	PF 1-11	1	4.72	120	2.91	74	2.44	62	32	41	43

*** 51 series field attachable couplings are not intended for use on hose that has previously been in service.**

(+) Non Standard. See page ii for information on non-standard products.

PTFE Hose & Fittings

Thermoplastic Tubing

Coiled Air Hose, Fittings & Accessories

Truck (Fleet) Products

Tooling & Equipment

Hose Accessories

Technical & Design Information

Approvals & Guides

Alphanumeric Index

10155 Male Taper Pipe Rigid

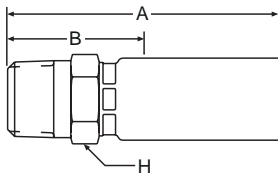

55 Series Permanent

Steel Part Number	B	C	NPTF Pipe Thread	Hose I. D.	A		Cutoff Allow. B		H Hex	Pusher Number
					inch	mm	inch	mm		
#										
Hose Fitting				inch	inch	mm	inch	mm	inch	
10157-2-2**	+	+	1/8-27	1/8	1.35	34	0.69	17	1/2	PUM 001
10155-2-3	+	+	1/8-27	3/16	1.94	49	1	25	9/16	PUM 001
10155-2-4	+	+	1/8-27	1/4	2.13	54	1	25	5/8	PUM 002
10157-4-2**	+	+	1/4-18	1/8	1.56	40	0.94	24	9/16	Crimp Only
10155-4-3	+	+	1/4-18	3/16	2.12	54	1.19	30	11/16	PUM 004
10155-4-4			1/4-18	1/4	2.31	59	1.19	30	11/16	PUM 004
10155-4-5	+	+	1/4-18	5/16	2.37	60	1.19	30	11/16	PUM 004
10155-4-6	+	+	1/4-18	3/8	2.66	68	1.31	33	3/4	PUM 005
10155-6-3	+	+	3/8-18	3/16	2.21	56	1.19	30	3/4	PUM 005
10155-6-4	+	+	3/8-18	1/4	2.41	61	1.31	33	3/4	PUM 005
10155-6-5	+	+	3/8-18	5/16	2.47	63	1.31	33	3/4	PUM 005
10155-6-6	+		3/8-18	3/8	2.66	68	1.31	33	3/4	PUM 005
10155-6-8	+	+	3/8-18	1/2	2.85	72	1.31	33	7/8	PUM 008
10155-8-6	+	+	1/2-14	3/8	2.91	74	1.56	40	15/16	PUM 009
10155-8-8	+		1/2-14	1/2	3.09	78	1.56	40	15/16	PUM 009
10155-8-10	+	+	1/2-14	5/8	3.20	81	1.50	38	1	PUM 025
10155-12-10	+	+	3/4-14	5/8	3.20	81	1.50	38	1-1/8	PUM 011
10155-12-12	+	+	3/4-14	3/4	3.28	83	1.56	40	1-1/8	PUM 011
10155-16-16	+	+	1-11-1/2	1	3.96	101	1.75	44	1-3/8	PUM 013

**Note: 57 Series should be used for the following hoses: 55LT-2, 53LT-2, 510C-2, 518C-2, 540N-2, 549-2.

10255 Female Taper Pipe Rigid

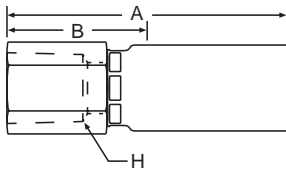

55 Series Permanent

Steel Part Number	B	C	NPTF Pipe Thread	Hose I. D.	A		Cutoff Allow. B		H Hex	Pusher Number
					inch	mm	inch	mm		
#										
Hose Fitting				inch	inch	mm	inch	mm	inch	
10255-4-4		+	1/4-18	1/4	2.37	60	1.25	32	3/4	PUF 002
10255-6-4	+	+	3/8-18	1/4	2.58	66	1.50	38	7/8	PUF 005
10255-6-6	+	+	3/8-18	3/8	2.77	70	1.50	38	7/8	PUF 005
10255-8-6	+	+	1/2-14	3/8	2.68	68	1.38	35	1-1/16	PUF 007
10255-8-8	+	+	1/2-14	1/2	2.87	73	1.38	35	1-1/16	PUF 007

[+] Non Standard. See page ii for information on non-standard products.

10355 Male (JIC) 37°

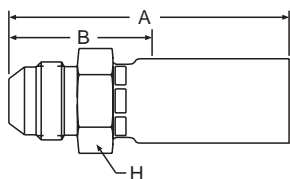

55 Series Permanent

Steel Part Number	B	C	Thread Size	Tube O. D.	Hose I.D.	A		Cutoff Allow. B		H Hex	Pusher Number
						inch	mm	inch	mm		
#											
Hose Fitting				inch	inch	inch	mm	inch	mm	inch	
10355-4-3	+	+	7/16-20	1/4	3/16	2.17	55	1.19	30	9/16	PUM 001
10355-4-4	+	+	7/16-20	1/4	1/4	2.30	58	1.19	30	5/8	PUM 002
10355-5-4	+	+	1/2-20	5/16	1/4	2.30	58	1.19	30	5/8	PUM 002
10355-5-5	+	+	1/2-20	5/16	5/16	2.30	58	1.19	30	5/8	PUM 002
10355-6-4	+	+	9/16-18	3/8	1/4	2.30	58	1.19	30	11/16	PUM 004
10355-6-5	+	+	9/16-18	3/8	5/16	2.30	58	1.19	30	11/16	PUM 004
10355-6-6	+	+	9/16-18	3/8	3/8	2.58	66	1.28	33	3/4	PUM 005
10355-8-6	+	+	3/4-16	1/2	3/8	2.68	68	1.38	35	13/16	PUM 007
10355-8-8	+	+	3/4-16	1/2	1/2	2.87	73	1.38	35	7/8	PUM 008
10355-8-10	+	+	3/4-16	1/2	5/8	3.10	79	1.44	37	1	PUM 025
10355-10-8	+	+	7/8-14	5/8	1/2	3.03	77	1.56	40	15/16	PUM 009
10355-12-8	+	+	1-1/16-12	3/4	1/2	3.14	80	1.66	42	1-1/8	PUM 011
10355-12-10	+	+	1-1/16-12	3/4	5/8	3.30	84	1.63	41	1-1/8	PUM 011
10355-12-12	+	+	1-1/16-12	3/4	3/4	3.32	84	1.66	42	1-1/8	PUM 011
10355-16-16	+	+	1-5/16-12	1	1	3.93	100	1.72	44	1-3/8	PUM 013

13E55 Male (JIC) 37° Long

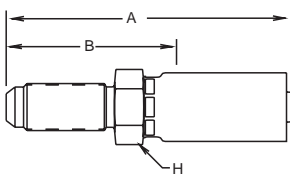

55 Series Permanent

Steel Part Number	B	C	Thread Size	Tube O. D.	Hose I.D.	A		Cutoff Allow. B		H Hex	Pusher Number
						inch	mm	inch	mm		
#											
Hose Fitting				inch	inch	inch	mm	inch	mm	inch	
13E55-4-4	+	+	7/16-20	1/4	1/4	2.93	74	1.81	46	11/16	PUM 002L
13E55-6-6	+	+	9/16-18	3/8	3/8	3.38	86	2	51	13/16	PUM 005L
13E55-8-8	+	+	3/4-16	1/2	1/2	3.72	94	2.13	54	1	PUM 008L

(+) Non Standard. See page ii for information on non-standard products.

10455 Male SAE 45°

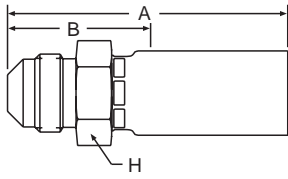

55 Series Permanent

Steel Part Number	B	C	Thread Size	Tube O. D.	Hose I.D.	A		Cutoff Allow. B		H Hex	Pusher Number
						inch	mm	inch	mm		
#											
Hose Fitting				inch	inch	inch	mm	inch	mm	inch	
10455-4-3	+	+	7/16-20	1/4	3/16	2.12	54	1.13	29	9/16	PUM 001
10455-5-4	+	+	1/2-20	5/16	1/4	2.31	59	1.19	30	5/8	PUM 002
10455-6-5	+	+	5/8-18	3/8	5/16	2.46	62	1.34	34	3/4	PUM 005
10455-6-6	+	+	5/8-18	3/8	3/8	2.65	67	1.34	34	3/4	PUM 005
10455-6-8	+	+	5/8-18	3/8	1/2	2.83	72	1.34	34	7/8	PUM 005
10455-8-8	+	+	3/4-16	1/2	1/2	2.96	75	1.47	37	7/8	PUM 008
10455-12-12	+	+	1-1/16-14	3/4	3/4	3.46	88	1.78	45	1-1/8	PUM 011

10555 Straight Thread O-Ring

(BUNA N O-Ring Included)

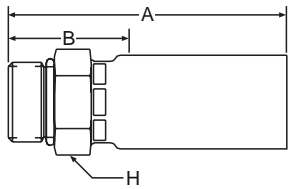

55 Series Permanent

Steel Part Number	B	C	Thread Size	Tube O. D.	Hose I.D.	A		Cutoff Allow. B		H Hex	Pusher Number
						inch	mm	inch	mm		
#											
Hose Fitting				inch	inch	inch	mm	inch	mm	inch	
10555-4-3	+	+	7/16-20	1/4	3/16	1.98	50	1.13	29	9/16	PUF 020
10555-4-4	+	+	7/16-20	1/4	1/4	2.11	54	1	25	5/8	PUF 021
10555-4-5	+	+	7/16-20	1/4	5/16	2.11	54	1	25	5/8	PUF 021
10555-5-4	+	+	1/2-20	5/16	1/4	2.11	54	1	25	5/8	PUF 021
10555-5-5	+	+	1/2-20	5/16	5/16	2.11	54	1	25	5/8	PUF 021
10555-6-3	+	+	9/16-18	1/4	3/16	1.95	50	1	25	11/16	PUF 022
10555-6-4	+	+	9/16-18	3/8	1/4	2.14	54	1.06	27	11/16	PUF 022
10555-6-6	+	+	9/16-18	3/8	3/8	2.42	61	1.19	30	3/4	PUF 023
10555-8-6	+	+	3/4-16	3/8	3/8	2.46	62	1.19	30	7/8	PUF 024
10555-8-8	+	+	3/4-16	1/2	1/2	2.65	67	1.19	30	7/8	PUF 024
10555-10-8	+	+	7/8-14	1/2	1/2	2.77	70	1.31	33	1	PUF 019

[+] Non Standard. See page ii for information on non-standard products.

10655 SAE (JIC) 37° Swivel

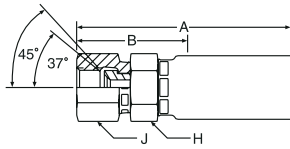

PTFE Hose & Fittings

Thermoplastic Tubing

Coiled Air Hose, Fittings & Accessories

Truck (Fleet) Products

Tooling & Equipment

Hose Accessories

Technical & Design Information

Approvals & Guides

Alphanumeric Index

55 Series Permanent

Steel Part Number	B	C	Thread Size	Tube O. D.	Hose I.D.	A		Cutoff Allow. B		H Hex	J Hex	Pusher Number
						inch	mm	inch	mm			
#												
Hose Fitting				inch	inch	inch	mm	inch	mm	inch	inch	
10657-2-2**	+	+	5/16-24	1/8	1/8	1.66	42	1	25	1/2	1/2	PUF 017
10657-4-2**	+	+	7/16-20	1/4	1/8	1.66	42	1	25	1/2	5/8	PUF 012
10655-3-3	+	+	3/8-24	3/16	3/16	2.23	57	1.31	33	9/16	9/16	PUF 017
10655-4-3	+		7/16-20	1/4	3/16	2.20	56	1.31	29	5/8	5/8	PUF 011
10655-5-3	+	+	1/2-20	5/16	3/16	2.25	57	1.25	32	9/16	3/4	PUF 002
10655-4-4			7/16-20	1/4	1/4	2.50	64	1.38	35	5/8	5/8	PUF 010
10655-5-4	+	+	1/2-20	5/16	1/4	2.50	64	1.38	35	5/8	3/4	PUF 013
10655-6-4	+	+	9/16-18	3/8	1/4	2.50	64	1.38	35	5/8	3/4	PUF 013
10655-5-5	+	+	1/2-20	5/16	5/16	2.50	64	1.38	35	5/8	3/4	PUF 013
10655-6-5	+		9/16-18	3/8	5/16	2.50	64	1.38	35	5/8	3/4	PUF 013
10655-6-6			9/16-18	3/8	3/8	2.78	71	1.50	38	3/4	3/4	PUF 015
10655-8-6	+		3/4-16	1/2	3/8	2.77	70	1.47	37	3/4	15/16	PUF 005
10655-6-8	+	+	9/16-18	3/8	1/2	2.96	75	1.47	37	7/8	3/4	PUF 015
10655-8-8	+		3/4-16	1/2	1/2	3.12	79	1.63	41	15/16	15/16	PUF 016
10655-8-10	+	+	3/4-16	1/2	5/8	3.30	84	1.63	41	1	15/16	PUF 016
10655-10-8	+	+	7/8-14	5/8	1/2	3.12	79	1.63	41	7/8	1-1/16	PUF 006
10655-12-8	+	+	1-1/16-12	3/4	1/2	3.21	82	1.72	44	1	1-1/4	PUF 008
10655-10-10	+	+	7/8-14	5/8	5/8	3.30	84	1.63	41	1	1-1/16	PUF 006
10655-12-10	+	+	1-1/16-12	3/4	5/8	3.40	86	1.75	44	1-1/8	1-5/16	PUF 008
10655-10-12	+	+	7/8-14	5/8	3/4	3.36	85	1.69	43	1-1/8	1-1/16	PUF 006
10655-12-12	+		1-1/16-12	3/4	3/4	3.40	86	1.72	44	1-1/8	1-1/4	PUF 008
10655-16-16	+	+	1-5/16-12	1	1	4.02	102	1.78	45	1-3/8	1-1/12	PUF 009

*316 stainless nipple, nut, shell

**Note: 57 Series should be used for the following hoses: 55LT-2, 53LT-2, 510C-2, 518C-2, 540N-2, 549-2.

[+] Non Standard. See page ii for information on non-standard products.



10755 Female Pipe Swivel

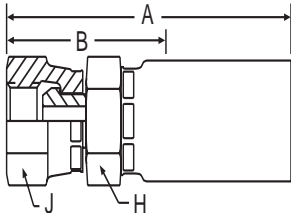

55 Series Permanent

Steel Part Number	B	C	Thread Size	Tube O. D.	Hose I. D.	A		Cutoff Allow. B		H Hex	J Hex	Pusher Number
						inch	mm	inch	mm			
#												
Hose Fitting				inch	inch	inch	mm	inch	mm	inch	inch	
10755-4-4	+	+	1/4-18	1/4	1/4	2.37	60	1.25	32	5/8	3/4	PUF 002
10755-4-5	+	+	1/4-18	1/4	5/16	2.50	64	1.38	35	3/4	3/4	PUF 013
10755-6-6	+	+	3/8-18	3/8	3/8	2.63	67	1.44	37	7/8	7/8	PUF 004
10755-8-8	+	+	1/2-14	1/2	1/2	2.97	75	1.50	38	1	1	PUF 018
10755-16-16 (+)	+	+	1-11-1/2	1	1	4.00	102	1.81	46	1-3/8	1-1/2	PUF 009

10855 SAE 45° Swivel

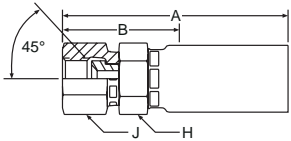

55 Series Permanent

Steel Part Number	B	C	Thread Size	Tube O. D.	Hose I. D.	A		Cutoff Allow. B		H Hex	J Hex	Pusher Number
						inch	mm	inch	mm			
#												
Hose Fitting				inch	inch	inch	mm	inch	mm	inch	inch	
10855-6-4	+	+	5/8-18	3/8	1/4	2.50	64	1.38	35	5/8	13/16	PUF 003
10855-6-5	+	+	5/8-18	3/8	5/16	2.50	64	1.38	35	5/8	13/16	PUF 003
10855-6-6	+	+	5/8-18	3/8	3/8	2.78	71	1.50	38	3/4	13/16	PUF 014
10855-8-6 (+)	+	+	3/4-16	1/2	3/8	2.78	71	1.44	37	3/4	15/16	PUF 005
10855-12-12	+	+	1-1/16-14	3/4	3/4	3.40	86	1.69	43	1-1/8	1-1/4	PUF 008

(+) Non Standard. See page ii for information on non-standard products.

11155 Ferrul-Fix

Nut and sleeve included

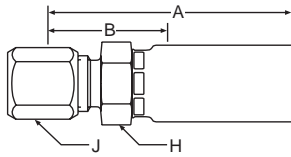

55 Series Permanent

Steel Part Number	B	C	Thread Size	Tube O. D.	Hose I.D.	A		Cutoff Allow. B		H Hex	J Hex	Pusher Number
						inch	mm	inch	mm			
#												
Hose Fitting				inch	inch	inch	mm	inch	mm	inch	inch	
11155-6-4	+	+	9/16-18	3/8	1/4	2.34	59	1.25	32	11/16	11/16	PUF 015
11155-6-6	+	+	9/16-18	3/8	3/8	2.53	64	1.25	32	3/4	11/16	PUF 015
11155-8-6	+	+	3/4-16	1/2	3/8	2.63	67	1.31	33	7/8	7/8	PUF 016
11155-8-8 (+)	+	+	3/4-16	1/2	1/2	2.83	72	1.31	33	7/8	7/8	PUF 016
11155-10-6	+	+	7/8-14	5/8	3/8	3.68	93	1.38	35	1	1	PUF 017
11155-10-8 (+)	+	+	7/8-14	5/8	1/2	2.88	73	1.44	37	1	1	PUF 017

Note: Nut Part Number is 111-size
Sleeve Part Number is 110-size

11255 SAE Flareless Swivel

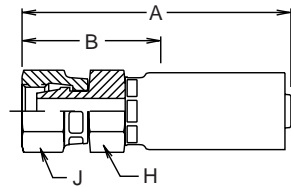

55 Series Permanent

Steel Part Number	B	C	Thread Size	Tube O. D.	Hose I.D.	A		Cutoff Allow. B		H Hex	J Hex	Pusher Number
						inch	mm	inch	mm			
#												
Hose Fitting				inch	inch	inch	mm	inch	mm	inch	inch	
11255-6-4	+	+	9/16-18	3/8	1/4	2.57	65	1.44	37	11/16	3/4	PUF 015
11255-6-6	+	+	9/16-18	3/8	3/8	2.76	70	1.44	37	3/4	3/4	PUF 015
11255-8-6 (+)	+	+	3/4-16	1/2	3/8	2.86	73	1.56	40	7/8	15/16	PUF 025
11255-8-8 (+)	+	+	3/4-16	1/2	1/2	3.05	77	1.06	27	7/8	15/16	PUF 025
11255-10-8 (+)	+	+	7/8-14	5/8	1/2	3.16	80	1.69	43	1	1-1/16	PUF 026

(+) Non Standard. See page ii for information on non-standard products.

11355 Male Pipe Swivel*

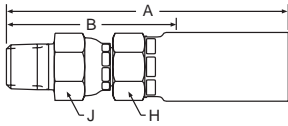

55 Series Permanent

Steel Part Number	B	C	Thread Size	Tube O. D.	Hose I.D.	A		Cutoff Allow. B		H Hex	J Hex	Pusher Number
						inch	mm	inch	mm			
#												
Hose Fitting				inch	inch	inch	mm	inch	mm	inch	inch	
11357-2-2**	+	+	1/8-27	1/8	1/8	1.96	50	1-1/4	32	1/2	1/2	-
11355-4-3	+	+	1/4-18	1/4	3/16	2.72	69	1.75	44	5/8	11/16	PUM 003
11355-4-4	+	+	1/4-18	1/4	1/4	2.84	72	1.75	44	5/8	11/16	PUM 003
11355-4-5	+	+	1/4-18	1/4	5/16	2.84	72	1.75	44	5/8	11/16	PUM 003
11355-6-6	+	+	3/8-18	3/8	3/8	3.12	79	1.81	46	3/4	3/4	PUM 006
11355-8-6	+	+	1/2-14	1/2	3/8	3.37	86	2.06	52	3/4	15/16	PUM 010
11355-8-8	+	+	1/2-14	1/2	1/2	3.56	90	2.06	52	7/8	15/16	PUM 010
11355-12-12	+	+	3/4-14	3/4	3/4	3.81	97	2.13	54	1-1/8	1-1/8	PUM 012
11355-16-16	+	+	1-11-1/2	1	1	5.06	129	2.81	71	1-1/2	1-1/2	PUM 030

*For use with petroleum based fluids.

WARNING: Fittings allow minor movement to relieve stress on hose but are not recommended for continued or extensive swiveling. Fittings are not recommended for use in CNG applications.

**Note: 57 Series should be used for the following hoses: 55LT-2, 53LT-2, 510C-2, 518C-2, 540N-2, 549-2.

11L55 Male Pipe Swivel 90° Elbow*

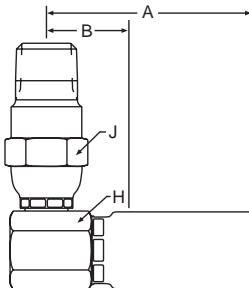

55 Series Permanent

Steel Part Number	B	C	Thread Size	Hose I.D.	A		Cutoff Allow. B		H Hex	J Hex	Pusher Number
					inch	mm	inch	mm			
#											
Hose Fitting				inch	inch	mm	inch	mm	inch	inch	
11L55-4-4	+	+	1/4-18	1/4	1.94	49	0.81	21	11/16	11/16	PUS 001

*For use with petroleum based fluids.

WARNING: Fittings allow minor movement under pressure to relieve stress on hose but are not recommended for continued or extensive swiveling. Fittings not recommended for use in CNG applications.

Note: Use crimp Die Ring 80C-R1L with Parkrimp 1 Machine; crimp Die Ring 82C-R1L with KarryKrimp. Consult factory for ordering information.

[+] Non Standard. See page ii for information on non-standard products.

13755 Female SAE (JIC) 37° Swivel 45° Elbow

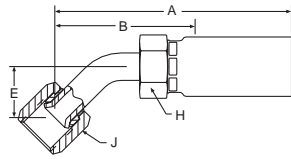

55 Series Permanent (SAE Drop Dimensions)

Steel Part Number	B	C	Thread Size	Tube O. D.	Hose I.D.	A		Cutoff Allow. B		E		H Hex	J Hex	Pusher Number
						inch	mm	inch	mm	inch	mm	inch	inch	
#														
Hose Fitting				inch	inch	inch	mm	inch	mm	inch	mm	inch	inch	
13757-4-2**	+	+	7/16-20	1/4	1/8	1.98	50	1-9/32	33	0.33	8	RND	9/16	-
13755-4-3	+	+	7/16-20	1/4	3/16	2.49	63	1.50	38	0.33	8	9/16	9/16	PUT 001
13755-4-4	+	+	7/16-20	1/4	1/4	2.49	63	1.50	38	0.33	8	5/8	9/16	PUT 002
13755-5-4	+	+	1/2-20	5/16	1/4	2.49	63	1.50	38	0.36	9	5/8	5/8	PUT 002
13755-6-5	+	+	9/16-18	3/8	5/16	2.73	69	1.56	40	0.39	10	5/8	11/16	PUT 002
13755-6-6	+	+	9/16-18	3/8	3/8	2.91	74	1.56	40	0.39	10	3/4	11/16	PUT 003
13755-8-6	+	+	3/4-16	1/2	3/8	3.18	81	1.81	46	0.55	14	3/4	7/8	PUT 003
13755-8-8	+	+	3/4-16	1/2	1/2	3.37	86	1.81	46	0.55	14	7/8	7/8	PUT 004
13755-10-8	+	+	7/8-14	5/8	1/2	3.42	87	1.88	48	0.63	16	7/8	1	PUT 004
13755-12-12	+	+	1-1/16-12	3/4	3/4	4.05	103	2.38	60	0.78	20	1-1/8	1-1/4	PUT 005
13755-16-16	+	+	1-5/16-12	1	1	4.57	116	2.31	59	0.89	23	1-3/8	1-1/2	PUT 007

**Note: 57 Series should be used for the following hoses: 55LT-2, 53LT-2, 510C-2, 518C-2, 540N-2, 549-2.

(+) Non Standard. See page ii for information on non-standard products.

13955 Female SAE (JIC) 37° Swivel 90° Elbow

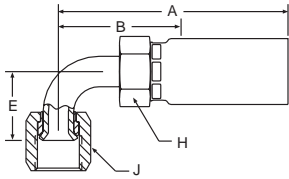

55 Series Permanent (SAE Drop Dimensions)

Steel Part Number	B	C	Thread Size	Tube O. D.	Hose I.D.	A		Cutoff Allow. B		E		H Hex	J Hex	Pusher Number
						inch	mm	inch	mm	inch	mm	inch	inch	
#														
Hose Fitting				inch	inch	inch	mm	inch	mm	inch	mm	inch	inch	
13957-4-2	+	+	7/16-20	1/4	1/8	1.87	48	1-3/16	30	0.68	17	RND	9/16	-
13955-4-3	+	+	7/16-20	1/4	3/16	2.49	60	1.38	35	0.68	17	9/16	9/16	PUT 001
13955-4-4	+	+	7/16-20	1/4	1/4	2.49	64	1.38	35	0.68	17	5/8	9/16	PUT 002
13955-5-4	+	+	1/2-20	5/16	1/4	2.49	68	1.56	40	0.77	20	5/8	5/8	PUT 002
13955-6-4	+	+	9/16-18	3/8	1/4	2.57	65	1.44	37	0.85	22	5/8	11/16	PUT 002
13955-6-5	+	+	9/16-18	3/8	5/16	2.73	67	1.50	38	0.85	22	5/8	11/16	PUT 002
13955-6-6	+	+	9/16-18	3/8	3/8	2.91	71	1.50	38	0.85	22	3/4	11/16	PUT 003
13955-8-6	+	+	3/4-16	1/2	3/8	3.18	75	1.63	41	1.09	28	3/4	7/8	PUT 003
13955-8-8	+	+	3/4-16	1/2	1/2	3.37	80	1.63	41	1.09	28	7/8	7/8	PUT 004
13955-10-8	+	+	7/8-14	5/8	1/2	3.42	83	1.75	44	1.23	31	7/8	1	PUT 004
13955-12-12	+	+	1-1/16-12	3/4	3/4	4.05	101	2.25	57	1.81	46	1-1/8	1-1/4	PUT 005
13955-16-16	+	+	1-5/16-12	1	1	4.57	121	2.56	65	2.14	54	1-3/8	1-1/2	PUT 007

**Note: 57 Series should be used for the following hoses: 55LT-2, 53LT-2, 510C-2, 518C-2, 540N-2, 549-2.

[+] Non Standard. See page ii for information on non-standard products.

14155 Female SAE (JIC) 37° Swivel 90° Long Elbow

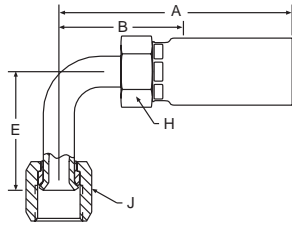

55 Series Permanent (SAE Drop Dimensions)

Steel Part Number	B	C	Thread Size	Tube O. D.	Hose I.D.	A		Cutoff Allow. B		E		H Hex	J Hex	Pusher Number
						inch	mm	inch	mm	inch	mm	inch	inch	
#														
Hose Fitting				inch	inch	inch	mm	inch	mm	inch	mm	inch	inch	
14155-4-3	+	+	7/16-20	1/4	3/16	2.37	60	1.38	35	1.80	46	9/16	9/16	PUT 001
14155-4-4	+	+	7/16-20	1/4	1/4	2.57	65	1.44	37	1.80	46	5/8	9/16	PUT 002
14155-5-4	+	+	1/2-20	5/16	1/4	2.51	64	1.38	35	1.80	46	5/8	5/8	PUT 002
14155-6-5	+	+	9/16-18	3/8	5/16	2.73	69	1.56	40	2.18	55	5/8	11/16	PUT 002
14155-6-6	+	+	9/16-18	3/8	3/8	2.92	74	1.56	40	2.18	55	3/4	11/16	PUT 003
14155-8-6	+	+	3/4-16	1/2	3/8	3.00	76	1.75	44	2.43	62	3/4	7/8	PUT 003
14155-8-8	+	+	3/4-16	1/2	1/2	3.18	81	1.63	41	2.43	62	7/8	7/8	PUT 004
14155-10-8	+	+	7/8-14	5/8	1/2	3.39	86	1.81	46	2.57	65	7/8	1	PUT 004
14155-12-12	+	+	1-1/16-12	3/4	3/4	3.91	99	2.19	56	3.73	95	1-1/8	1-1/4	PUT 005
14155-16-16	+	+	1-5/16-12	1	1	4.62	117	2.38	60	4.33	110	1-3/8	1-1/2	PUT 007

(+) Non Standard. See page ii for information on non-standard products.

1L955 Female (JIC) 37° Swivel 90° Elbow Special

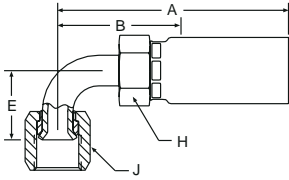

55 Series Permanent

Steel Part Number	B	C	Thread Size	Tube O. D.	Hose I.D.	A		Cutoff Allow. B		E		H Hex	J Hex	Pusher Number
						inch	mm	inch	mm	inch	mm	inch	inch	
#														
Hose Fitting				inch	inch	inch		inch	mm	inch	mm	inch	inch	
1L955-4-3	+	+	7/16-20	1/4	3/16	2.31	59	1.38	35	0.88	22	9/16	9/16	PUT 001
1L955-4-4	+	+	7/16-20	1/4	1/4	2.47	63	1.38	35	0.88	22	5/8	9/16	PUT 002
1L955-5-4	+	+	1/2-20	5/16	1/4	2.53	64	1.44	37	0.88	22	5/8	5/8	PUT 002
1L955-6-5	+	+	9/16-18	3/8	5/16	2.69	68	1.50	38	1.12	28	5/8	11/16	PUT 002
1L955-6-6	+	+	9/16-18	3/8	3/8	2.88	73	1.50	38	1.12	28	3/4	11/16	PUT 003
1L955-8-6	+	+	3/4-16	1/2	3/8	3.00	76	1.63	41	1.38	35	3/4	7/8	PUT 003
1L955-8-8	+	+	3/4-16	1/2	1/2	3.19	81	1.63	41	1.38	35	7/8	7/8	PUT 004
1L955-10-8	+	+	7/8-14	5/8	1/2	3.68	93	2.13	54	1.75	44	7/8	1	PUT 004
1L955-12-12	+	+	1-1/16-12	3/4	3/4	4.29	109	2.50	64	2.06	52	1-1/8	1-1/4	PUT 005
1L955-16-16	+	+	1-5/16-12	1	1	5.14	131	2.75	70	2.50	64	1-3/8	1-1/2	PUT 007

16755 SAE Male Inverted Swivel 45° Elbow

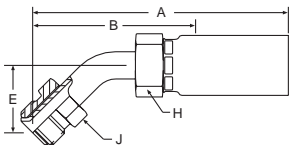

55 Series Permanent

Steel Part Number	B	C	Thread Size	Tube O. D.	Hose I.D.	A		Cutoff Allow. B		E		H Hex	J Hex	Pusher Number
						inch	mm	inch	mm	inch	mm	inch	inch	
#														
Hose Fitting				inch	inch	inch	mm	inch	mm	inch	mm	inch	inch	
16755-6-6	+	+	5/8-18	3/8	3/8	3.48	88	2.13	54	0.94	24	3/4	5/8	PUT 003

[+] Non Standard. See page ii for information on non-standard products.

16955 SAE Male Inverted Swivel 90° Elbow

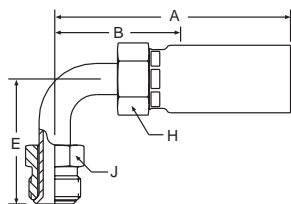

55 Series Permanent

Steel Part Number	B	C	Thread Size	Tube O. D.	Hose I.D.	A		Cutoff Allow. B		E		H Hex	J Hex	Pusher Number
						inch	mm	inch	mm	inch	mm			
#														
Hose Fitting				inch	inch	inch	mm	inch	mm	inch	mm	inch	inch	
16955-4-4 (+)	+	+	7/16-24	1/4	1/4	2.75	70	1.63	27	1.56	40	5/8	7/16	PUT 002
16955-6-6	+	+	5/8-18	3/8	3/8	3.48	78	1.75	27	1.69	43	3/4	5/8	PUT 003

1JS55 Seal-Lok™ Straight

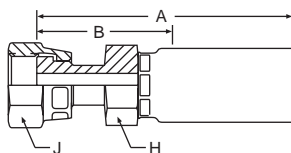

55 Series Permanent

Steel Part Number	C	Thread Size	Tube O. D.	Hose I.D.	A		Cutoff Allow. B		H Hex	J Hex	Pusher Number
					inch	mm	inch	mm			
#											
Hose Fitting			inch	inch	inch	mm	inch	mm	inch	inch	
1JS57-4-2**	+	9/16-18	1/4	1/8	1.60	41	15/16	24	5/8	11/16	-
1JS55-4-3 (+)	+	9/16-18	1/4	3/16	2.40	61	1.50	38	5/8	11/16	PUT 002
1JS55-4-4	+	9/16-18	1/4	1/4	2.59	66	1.50	38	5/8	11/16	PUT 002
1JS55-6-4	+	11/16-16	3/8	1/4	2.58	66	1.50	38	3/4	13/16	PUT 003
1JS55-4-5 (+)	+	9/16-18	1/4	5/16	2.66	68	1.50	38	5/8	11/16	PUT 002
1JS55-6-5	+	11/16-16	3/8	5/16	2.66	68	1.50	38	3/4	13/16	PUT 003
1JS55-6-6	+	11/16-16	3/8	3/8	2.86	73	1.50	38	3/4	13/16	PUT 003
1JS55-8-6	+	13/16-16	1/2	3/8	3.00	76	1.63	41	7/8	15/16	PUT 004
1JS55-8-8	+	13/16-16	1/2	1/2	3.20	81	1.63	41	7/8	15/16	PUT 004
1JS55-10-10 (+)	+	1-14	5/8	5/8	3.53	90	1.88	48	1-1/8	1-1/8	PUT 005
1JS55-12-12	+	1-3/16-12	3/4	3/4	3.75	95	2	51	1-1/4	1-3/8	PUT 005
1JS55-16-16 (+)	+	1-7/16-12	1	1	4.28	109	2.06	52	1-1/2	1-5/8	PUT 015

**Note: 57 Series should be used for the following hoses: 55LT-2, 53LT-2, 510C-2, 518C-2, 540N-2, 549-2.

(+) Non Standard. See page ii for information on non-standard products.



1JC55 Seal-Lok™ Straight-Short

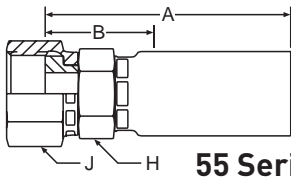

55 Series Permanent

Steel Part Number	C	Thread Size	Tube O. D.	Hose I.D.	A		Cutoff Allow. B		H Hex	J Hex	Pusher Number
					inch	mm	inch	mm			
#											
Hose Fitting			inch	inch	inch	mm	inch	mm	inch	inch	
1JC57-4-2**	+	9/16-18	1/4	1/8	1.34	34	5/8	16	5/8	11/16	-
1JC55-4-3	+	9/16-18	1/4	3/16	1.97	50	1.06	27	5/8	11/16	PUL 001
1JC55-4-4		9/16-18	1/4	1/4	2.16	55	1.06	27	5/8	11/16	PUL 001
1JC55-6-4	+	11/16-16	3/8	1/4	2.19	56	1.06	27	3/4	13/16	PUL 002
1JC55-4-5	+	9/16-18	1/4	5/16	2.22	56	1.06	27	5/8	11/16	PUL 001
1JC55-6-5	+	11/16-16	3/8	5/16	2.28	58	1.06	27	3/4	13/16	PUL 002
1JC55-6-6	+	11/16-16	3/8	3/8	2.47	63	1.06	27	3/4	13/16	PUL 002
1JC55-8-6	+	13/16-16	1/2	3/8	2.56	65	1.19	30	7/8	15/16	PUL 003
1JC55-8-8	+	13/16-16	1/2	1/2	2.75	70	1.19	30	7/8	15/16	PUL 003
1JC55-10-8	+	1-14	5/8	1/2	2.95	75	1.38	35	1-1/8	1-1/8	PUL 004
1JC55-8-10 (+)	+	13/16-16	1/2	5/8	2.85	72	1.19	30	1	15/16	PUL 010
1JC55-10-10	+	1-14	5/8	5/8	3.05	77	1.38	35	1-1/8	1-1/8	PUL 004
1JC55-10-12	+	1-14	5/8	3/4	3.15	80	1.38	35	1-1/8	1-1/8	PUL 004
1JC55-12-8	+	1-3/16-12	3/4	1/2	3.00	76	1.44	37	1-1/4	1-3/8	PUL 006
1JC55-12-10	+	1-3/16-12	3/4	5/8	3.10	79	1.44	37	1-1/4	1-3/8	PUL 006
1JC55-12-12	+	1-3/16-12	3/4	3/4	3.20	81	1.44	37	1-1/4	1-3/8	PUL 006
1JC55-16-16	+	1-7/16-12	1	1	3.74	95	1.50	38	1-1/2	1-5/8	PUL 008

**Note: 57 Series should be used for the following hoses: 55LT-2, 53LT-2, 510C-2, 518C-2, 540N-2, 549-2.

1J055 Male Seal-Lok™ – Rigid Straight (with O-Ring)

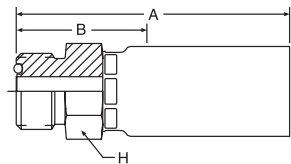

55 Series Permanent

Steel Part Number	C	Thread Size	Tube O. D.	Hose I.D.	A		Cutoff Allow. B		H Hex	Pusher Number
					inch	mm	inch	mm		
#										
Hose Fitting			inch	inch	inch	mm	inch	mm		
1J055-4-3 (+)	+	9/16-18	1/4	3/16	1.95	50	1.13	29	5/8	PUM 004
1J055-4-4	+	9/16-18	1/4	1/4	2.20	56	1.06	27	5/8	PUM 004
1J055-6-4 (+)	+	11/16-16	3/8	1/4	2.28	58	1.13	29	3/4	PUM 005
1J055-4-5 (+)	+	9/16-18	1/4	5/16	2.20	56	1.06	27	5/8	PUM 004
1J055-6-5 (+)	+	11/16-16	3/8	5/16	2.28	58	1.13	29	3/4	PUM 005
1J055-6-6	+	11/16-16	3/8	3/8	2.47	63	1.13	29	3/4	PUM 005
1J055-8-6 (+)	+	13/16-16	1/2	3/8	2.56	65	1.25	32	7/8	PUM 008
1J055-8-8 (+)	+	13/16-16	1/2	1/2	2.75	70	1.25	32	15/16	PUM 009
1J055-10-10 (+)	+	1-14	5/8	5/8	3.10	79	1.44	37	1-1/8	PUM 011
1J055-12-12 (+)	+	1-3/16-12	3/4	3/4	3.25	83	1.56	40	1-3/8	PUM 013
1J055-16-16 (+)	+	1-7/16-12	1	1	3.86	98	1.63	41	1-5/8	PUM 020

(+) Non Standard. See page ii for information on non-standard products.



Hydraulic & Pneumatic Hose & Fit.
 PTFE Hose & Fittings
 Thermoplastic Tubing
 Coiled Air Hose, Fittings & Accessories
 Truck (Fleet) Products
 Tooling & Equipment
 Hose Accessories
 Technical & Design Information
 Approvals & Guides
 Alphanumeric Index

1J155 Seal-Lok™ 90° Elbow (Long)

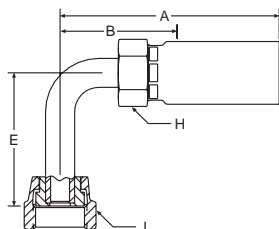

55 Series Permanent (SAE Drop Dimensions)

Steel Part Number	C	Thread Size	Tube O. D.	Hose I.D.	A		Cutoff Allow. B		E		H Hex	J Hex	Pusher Number
					inch	mm	inch	mm	inch	mm	inch	inch	
#													
Hose Fitting			inch	inch	inch	mm	inch	mm	inch	mm	inch	inch	
1J157-4-2**	+	9/16-18	1/4	1/8	1.82	46	1-1/8	29	1.80	46	1/2	11/16	-
1J155-4-3 (+)	+	9/16-18	5/16	3/16	2.30	58	1.31	33	1.80	46	9/16	11/16	PUT 002
1J155-4-4	+	9/16-18	5/16	1/4	2.45	62	1.31	33	1.80	46	9/16	11/16	PUT 002
1J155-4-5 (+)	+	9/16-18	5/16	5/16	2.54	65	1.31	33	1.80	46	5/8	11/16	PUT 002
1J155-6-5 (+)	+	11/16-16	3/8	5/16	2.76	70	1.63	41	2.13	54	5/8	13/16	PUT 003
1J155-6-6	+	11/16-16	3/8	3/8	2.94	75	1.63	41	2.13	54	3/4	13/16	PUT 003
1J155-8-6	+	13/16-16	1/2	3/8	2.94	75	1.69	43	2.51	64	3/4	15/16	PUT 004
1J155-8-8	+	13/16-16	1/2	1/2	3.21	82	1.69	43	2.51	64	7/8	15/16	PUT 004
1J155-10-10 (+)	+	1-14	5/8	5/8	3.35	85	2.00	51	2.76	70	1	1-1/8	PUT 005
1J155-12-12	+	1-3/16-12	3/4	3/4	3.86	98	2.13	54	3.78	96	1-1/8	1-3/8	PUT 005
1J155-16-16	+	1-7/16-12	1	1	4.42	112	2.38	60	4.50	114	1-3/8	1-5/8	PUT 007

**Note: 57 Series should be used for the following hoses: 55LT-2, 53LT-2, 510C-2, 518C-2, 540N-2, 549-2.

(+) Non Standard. See page ii for information on non-standard products.



1J755 Seal-Lok™ 45° Elbow

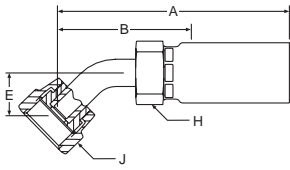

55 Series Permanent (SAE Drop Dimensions)

Steel Part Number	C	Thread Size	Tube O. D.	Hose I.D.	A		Cutoff Allow. B		E		H Hex	J Hex	Pusher Number
					inch	mm	inch	mm	inch	mm			
#													
Hose Fitting			inch	inch	inch	mm	inch	mm	inch	mm	inch	inch	
1J757-4-2**	+	9/16-18	1/4	1/8	2.46	63	1-3/8	35	0.41	10	1/2	11/16	-
1J755-4-4	+	9/16-18	1/4	1/4	2.66	68	1.50	38	0.41	10	5/8	11/16	PUT 002
1J755-6-4	+	11/16-16	3/8	1/4	2.74	70	1.63	41	0.43	11	5/8	13/16	PUT 003
1J755-6-6	+	11/16-16	3/8	3/8	2.98	76	1.69	43	0.43	11	3/4	13/16	PUT 003
1J755-8-6	+	13/16-16	1/2	3/8	3.23	82	1.88	48	0.59	15	3/4	15/16	PUT 004
1J755-8-8	+	13/16-16	1/2	1/2	3.43	87	1.94	49	0.59	15	7/8	15/16	PUT 004
1J755-12-12	+	1-3/16-12	3/4	3/4	3.67	93	2.00	51	0.81	21	1-1/8	1-3/8	PUT 005
1J755-16-16	+	1-7/16-12	1	1	5.10	130	2.88	73	0.94	24	1-3/8	1-5/8	PUT 007

**Note: 57 Series should be used for the following hoses: 55LT-2, 53LT-2, 510C-2, 518C-2, 540N-2, 549-2.

1J955 Seal-Lok™ 90° Elbow

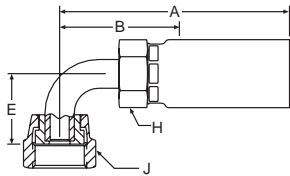

55 Series Permanent (SAE Drop Dimensions)

Steel Part Number	C	Thread Size	Tube O. D.	Hose I.D.	A		Cutoff Allow. B		E		H Hex	J Hex	Pusher Number
					inch	mm	inch	mm	inch	mm			
#													
Hose Fitting			inch	inch	inch	mm	inch	mm	inch	mm	inch	inch	
1J957-4-2**	+	9/16-18	1/4	1/8	1.82	46	1-1/8	29	0.82	21	RND	2.02	-
1J955-4-4	+	9/16-18	1/4	1/4	2.49	63	1.38	35	0.82	21	5/8	11/16	PUT 002
1J955-6-4	+	11/16-16	3/8	1/4	2.59	66	1.44	37	0.90	23	5/8	13/16	PUT 003
1J955-6-5	+	11/16-16	3/8	5/16	2.66	68	1.50	38	0.90	23	5/8	13/16	PUT 003
1J955-6-6	+	11/16-16	3/8	3/8	2.85	72	1.56	40	0.90	23	3/4	13/16	PUT 003
1J955-8-8	+	13/16-16	1/2	1/2	3.15	80	1.63	41	1.15	30	7/8	15/16	PUT 004
1J955-10-10	+	1-14	5/8	5/8	3.26	83	1.63	41	1.27	32	1	1-1/4	PUT 006
1J955-12-12	+	1-3/16-12	3/4	3/4	3.82	89	2.13	54	1.85	47	1-3/8	1-3/8	PUT 005
1J955-16-16	+	1-7/16-12	1	1	5.03	128	2.94	75	2.21	56	1-3/8	1-5/8	PUT 007

**Note: 57 Series should be used for the following hoses: 55LT-2, 53LT-2, 510C-2, 518C-2, 540N-2, 549-2.

[+] Non Standard. See page ii for information on non-standard products.



Hydraulic & Pneumatic Hose & Fit.
PTFE Hose & Fittings
Thermoplastic Tubing
Coiled Air Hose, Fittings & Accessories
Truck (Fleet) Products
Tooling & Equipment
Hose Accessories
Technical & Design Information
Approvals & Guides
Alphanumeric Index

1TU55 Universal Tube Stub End

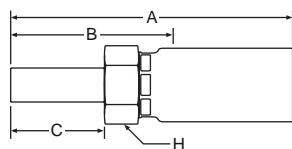

55 Series Permanent

Steel Part Number	C	Tube O. D.	Hose I.D.	A		Cutoff Allow. B		C		H Hex	Pusher Number
				inch	mm	inch	mm	inch	mm		
#											
Hose Fitting		inch	inch	inch	mm	inch	mm	inch	mm	inch	
1TU55-4-4		1/4	1/4	2.60	66	1.50	38	0.72	18	5/8	PUT 001
1TU55-5-5 (+)	+	5/16	5/16	2.69	68	1.50	38	0.75	19	11/16	PUT 002
1TU55-6-6		3/8	3/8	2.91	74	1.50	38	0.78	20	3/4	PUT 003
1TU55-8-8		1/2	1/2	3.35	85	1.81	46	1.03	26	7/8	PUT 004
1TU55-10-10 (+)	+	5/8	5/8	3.45	88	1.81	46	1.03	26	1	PUT 004
1TU55-12-12	+	3/4	3/4	3.66	93	1.94	49	1.03	26	1-1/8	PUT 005
1TU55-16-16		1	1	4.41	112	2.19	56	1.29	33	1-3/8	PUT 007

1AL55N A-LOK®/CPI Compression (Without Nut and Ferrule)

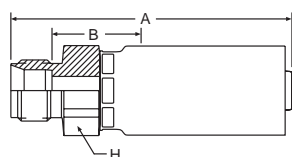

55 Series Permanent

Steel Part Number	C	Thread Size	Tube O. D.	Hose I.D.	A		Cutoff Allow. B		H Hex	Pusher Number
					inch	mm	inch	mm		
#										
Hose Fitting			inch	inch	inch	mm	inch	mm	inch	
1AL55-4-4N (+)	+	7/16-20	1/4	1/4	2.16	55	0.69	17	9/16	PUM 002
1AL55-6-6N (+)	+	9/16-20	3/8	3/8	2.56	65	0.81	21	3/4	PUM 005
1AL55-8-8N (+)	+	3/4-20	1/2	1/2	2.81	71	0.75	19	7/8	PUM 009

*316 Stainless nipple and shell.

Contact the Instrumentation Connectors Division in Huntsville, Alabama, (Phone: 256-881-2040) directly for correct installation and application information.

(+) Non Standard. See page ii for information on non-standard products.

1AL55 A-LOK® Compression (With Nut and Ferrule)

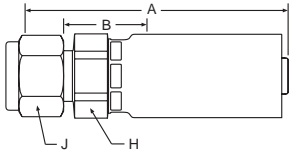

55 Series Permanent

Steel Part Number	C	Thread Size	Tube O. D.	Hose I.D.	A		Cutoff Allow. B		H Hex	J Hex	Pusher Number
					inch	mm	inch	mm			
#											
Hose Fitting			inch	inch	inch		inch	mm	inch	inch	
1AL55-4-4 (+)		7/16-20	1/4	1/4	2.16	55	0.69	17	5/8	9/16	PUM 002
1AL55-6-6 (+)		9/16-20	3/8	3/8	2.56	65	0.81	21	3/4	11/16	PUM 005
1AL55-8-8 (+)		3/4-20	1/2	1/2	2.81	71	0.75	19	15/16	7/8	PUM 009

*316 Stainless nipple and shell.

Note: Nut part No. is **XNUX** or **XNUX-316** for stainless steel.

Front ferrule part No. is **XFFX** or **XFFX-316** for stainless steel.

Back ferrule part No. is **XBFX** or **XBFX-316** for stainless steel.

X denotes dash size.

Please reference Instrument Tubing Selection Guide, Bulletin 4200-TS, or contact the Instrumentation Connectors Division in Huntsville, Alabama, (Phone: 256-881-2040) directly for correct installation and application information.

1P655 CPI Compression (With Nut and Ferrule)

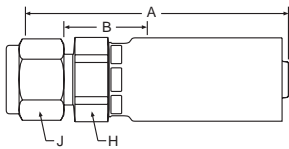

55 Series Permanent

Steel Part Number	C	Thread Size	Tube O. D.	Hose I.D.	A		Cutoff Allow. B		H Hex	J Hex	Pusher Number
					inch	mm	inch	mm			
#											
Hose Fitting			inch	inch	inch		inch	mm	inch	inch	
1P655-4-4 (+)		7/16-20	1/4	1/4	2.16	55	0.69	17	5/8	9/16	PUM 002
1P655-6-6 (+)		9/16-20	3/8	3/8	2.56	65	0.81	21	3/4	11/16	PUM 005
1P655-8-8 (+)		3/4-20	1/2	1/2	2.81	71	0.75	19	15/16	7/8	PUM 009

*316 Stainless nipple and shell.

Note: Nut part No. is **XBZ** or **XBZ-SS** for stainless steel.

Ferrule part No. is **XTZ** or **XTZ-SS** for stainless steel.

X denotes dash size.

Please reference Instrument Tubing Selection Guide, Bulletin 4200-TS, or contact the Instrumentation Connectors Division in Huntsville, Alabama, (Phone: 256-881-2040) directly for correct installation and application information.

(+) Non Standard. See page ii for information on non-standard products.

1UT55 Male (JIS)/BSPT

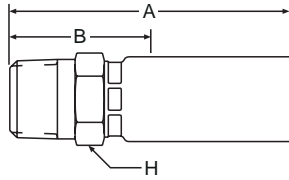

55 Series Permanent

Steel Part Number	C	BSP Thread Size	Hose I.D.	A		Cutoff Allow. B		H Hex	Pusher Number
				inch	mm	inch	mm		
#									
Hose Fitting			inch	inch	mm	inch	mm	mm	
1UT55-4-3 (+)	+	PT 1/4-19	3/16	2.20	56	1.26	32	19	PUM 005
1UT55-4-4 (+)	+	PT 1/4-19	1/4	2.36	60	1.26	32	19	PUM 005
1UT55-6-6 (+)	+	PT 3/8-19	3/8	2.68	68	1.26	32	22	PUM 008
1UT55-8-8 (+)	+	PT 1/2-14	1/2	3.03	77	1.50	38	27	PUM 506
1UT55-12-12 (+)	+	PT 3/4-14	3/4	3.35	85	1.57	40	36	PUM 510
1UT55-16-16 (+)	+	PT 1-11	1	4.06	103	1.81	46	41	PUM 020

1FU55 (JIS)/BSP 30° Flare Female Swivel

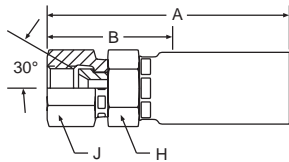

55 Series Permanent

Steel Part Number	B	C	BSP Thread Size	Hose I.D.	A		Cutoff Allow. B		H Hex	J Hex	Pusher Number
					inch	mm	inch	mm			
#											
Hose Fitting	+	+		inch	inch	mm	inch	mm	mm	mm	
1FU55-4-4	+	+	PF 1/4-19	1/4	2.32	59	1.26	32	19	19	PUF 002
1FU55-6-6	+	+	PF 3/8-19	3/8	2.68	68	1.30	33	19	22	PUF 004
1FU55-8-8	+	+	PF 1/2-14	1/2	3.19	81	1.61	41	27	27	PUF 006
1FU55-12-12	+	+	PF 3/4-14	3/4	3.54	90	1.73	44	27	36	PUF 009
1FU55-16-16	+	+	PF 1-11	1	4.09	104	1.89	48	41	41	PUF 030

(+) Non Standard. See page ii for information on non-standard products.

PTFE Hose & Fittings

Thermoplastic Tubing

Coiled Air Hose, Fittings & Accessories

Truck (Fleet) Products

Tooling & Equipment

Hose Accessories

Technical & Design Information

Approvals & Guides

Alphanumeric Index

1MU55 (JIS) Metric 30° Flare Female Swivel

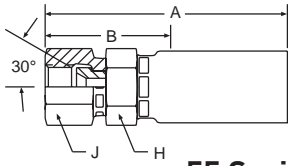

55 Series Permanent

Steel Part Number	B	C	Thread Size	Hose I.D.	A		Cutoff Allow. B		H Hex	J Hex	Pusher Number
					inch	mm	inch	mm			
#											
Hose Fitting				inch	inch	mm	inch	mm	mm	mm	
1MU55-4-4 (+)	+	+	M14 x 1,5	1/4	2.32	59	1.26	32	19	19	PUF 002
1MU55-6-6 (+)	+	+	M18 x 1,5	3/8	2.60	66	1.30	33	19	22	PUF 004
1MU55-8-8 (+)	+	+	M22 x 1,5	1/2	3.15	80	1.61	41	27	27	PUF 032
1MU55-8-10 (+)	+	+	M22 x 1,5	5/8	3.27	83	1.61	41	27	27	PUF 006
1MU55-12-12 (+)	+	+	M27 x 1,5	3/4	3.50	89	1.73	44	27	36	PUF 009
1MU55-16-16 (+)	+	+	M33 x 1,5	1	4.06	103	1.89	48	41	41	PUF 030

1GU55 (JIS)/BSP 60° Cone Female Swivel

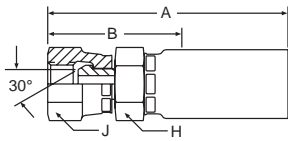

55 Series Permanent

Steel Part Number	B	C	Thread Size	Hose I.D.	A		Cutoff Allow. B		H Hex	J Hex	Pusher Number
					inch	mm	inch	mm			
#											
Hose Fitting				inch	inch	mm	inch	mm	mm	mm	
1GU55-4-4	+	+	PF 1/4-19	1/4	2.32	59	1.26	32	19	19	PUF 002
1GU55-6-6	+	+	PF 3/8-19	3/8	2.76	70	1.38	35	22	22	PUF 004
1GU55-8-8	+	+	PF 1/2-14	1/2	3.24	82	1.68	43	27	27	PUF 006
1GU55-8-10 (+)	+	+	PF 1/2-14	5/8	3.34	82	1.68	43	27	27	PUF 006
1GU55-12-12 (+)	+	+	PF 3/4-14	3/4	3.54	90	1.73	44	27	36	PUF 009
1GU55-16-16 (+)	+	+	PF 1-11	1	4.32	110	2.06	52	41	41	PUF 030

(+) Non Standard. See page ii for information on non-standard products.

1G155 (JIS)/BSP 60° Cone Female Swivel 45° Elbow

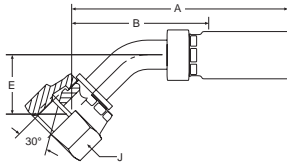

55 Series Permanent

Steel Part Number	B	C	Thread Size	Hose I.D.	A		Cutoff Allow. B		E		J Hex	Pusher Number
					inch	mm	inch	mm	inch	mm		
#												
Hose Fitting				inch	inch	mm	inch	mm	inch	mm	inch/mm	
1G155-4-3 (+)	+	+	PF 1/4-19	3/16	2.83	72	1.93	49	0.85	20	9/16	PUT 001
1G155-4-4 (+)	+	+	PF 1/4-19	1/4	2.99	76	1.93	49	0.85	20	9/16	PUT 002
1G155-6-6 (+)	+	+	PF 3/8-19	3/8	3.39	86	1.89	48	0.83	21	22	PUT 003
1G155-8-8 (+)	+	+	PF 1/2-14	1/2	3.74	95	2.05	52	0.98	25	27	PUT 0004

1G255 (JIS)/BSP 60° Cone Female Swivel 90° Elbow

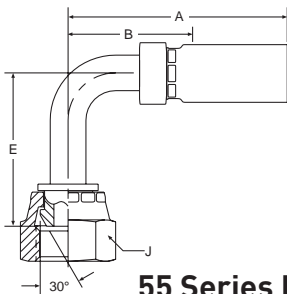

55 Series Permanent

Steel Part Number	B	C	Thread Size	Hose I.D.	A		Cutoff Allow. B		E		J Hex	Pusher Number
					inch	mm	inch	mm	inch	mm		
#												
Hose Fitting				inch	inch	mm	inch	mm	inch	mm	mm	
1G255-4-3 (+)	+	+	PF 1/4-19	3/16	2.28	58	1.34	34	0.94	24	19	PUT 001
1G255-4-4 (+)	+	+	PF 1/4-19	1/4	2.44	62	1.34	34	0.94	24	19	PUT 002
1G255-6-6 (+)	+	+	PF 3/8-19	3/8	3.07	78	1.69	43	1.50	38	22	PUT 003
1G255-8-8 (+)	+	+	PF 1/2-14	1/2	3.31	84	1.77	45	1.81	46	27	PUT 0004

(+) Non Standard. See page ii for information on non-standard products.

1C655 Metric Swivel DIN 20078 Heavy Series (Without O-Ring) 1C955 (With O-Ring)

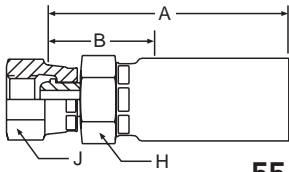

55 Series Permanent

Steel Part Number	C	Thread Size	Hose I.D.	A		Cutoff Allow. B		H Hex	J Hex	Pusher Number
				inch	mm	inch	mm			
#										
Hose Fitting			inch	inch	mm	inch	mm	mm	mm	
1C655-8-3 (+)	+	M16 x 1,5	3/16	2.09	53	1.06	27	19	22	PUM 503
1C655-10-4 (+)	+	M18 x 1,5	1/4	2.31	59	1.13	29	22	24	PUM 504
1C655-12-5	+	M20 x 1,5	5/16	2.45	62	1.19	30	24	24	PUM 505
1C655-14-6	+	M22 x 1,5	3/8	2.70	69	1.24	31	27	27	PUM 507
1C655-16-8	+	M24 x 1,5	1/2	2.87	73	1.26	32	27	30	PUM 507
1C655-20-12	+	M30 x 2	3/4	3.22	82	1.30	34	36	36	PUM 510
1C655-25-12 (+)	+	M36 x 2	3/4	3.23	82	1.38	35	41	42	PUM 511
1C655-30-16	+	M42 x 2	1	3.90	99	1.34	34	46	46	PUM 512

1D055 Male Stud DIN 20078 Light Series

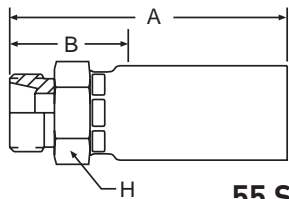

55 Series Permanent

Steel Part Number	C	Thread Size	Tube O.D.	Hose I.D.	A		Cutoff Allow. B		H Hex	Pusher Number
					inch	mm	inch	mm		
#										
Hose Fitting				inch	inch	mm	inch	mm	mm	
1D055-6-3	+	M12 x 1,5	6	3/16	2.01	51	0.98	25	17	PUM 502
1D055-8-4	+	M14 x 1,5	8	1/4	2.17	55	0.98	25	19	PUM 503
1D055-10-5	+	M16 x 1,5	10	5/16	2.28	58	1.02	26	19	PUM 503
1D055-12-5	+	M18 x 1,5	12	3/8	2.32	59	1.06	27	22	PUM 504
1D055-10-6	+	M16 x 1,5	10	3/8	2.52	64	1.02	26	22	PUM 503
1D055-12-6	+	M18 x 1,5	12	3/8	2.52	64	1.06	27	22	PUM 504
1D055-15-8 (+)	+	M22 x 1,5	15	1/2	2.80	71	1.18	30	27	PUM 507
1D055-18-12	+	M26 x 1,5	18	3/4	3.03	77	1.18	30	32	PUM 509
1D055-22-12 (+)	+	M30 x 2	22	3/4	3.11	79	1.22	31	26	PUM 510
1D055-28-16 (+)	+	M36 x 2	28	1	3.54	90	1.22	31	41	PUM 511

(+) Non Standard. See page ii for information on non-standard products.

1D255 Male Stud DIN 20078 Heavy Series

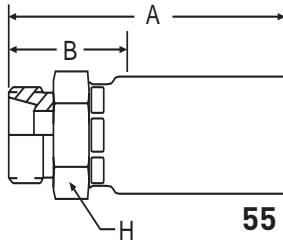

55 Series Permanent

Steel Part Number	C	Thread Size	Tube O.D.	Hose I.D.	A		Cutoff Allow. B		H Hex	Pusher Number
					inch	mm	inch	mm		
#										
Hose Fitting				inch	inch	mm	inch	mm	mm	
1D255-8-3 (+)	+	M16 x 1,5	8	3/16	2.09	53	1.06	27	19	PUM 503
1D255-10-4	+	M18 x 1,5	10	1/4	2.28	58	1.10	28	22	PUM 504
1D255-12-5	+	M20 x 1,5	12	5/16	2.44	62	1.18	30	24	PUM 505
1D255-12-6 (+)	+	M20 x 1,5	12	3/8	2.64	67	1.18	30	24	PUM 505
1D255-14-6	+	M22 x 1,5	14	3/8	2.72	69	1.26	32	27	PUM 507
1D255-14-8 (+)	+	M22 x 1,5	14	1/2	2.87	73	1.26	32	27	PUM 507
1D255-16-8 (+)	+	M24 x 1,5	16	1/2	2.87	73	1.26	32	27	PUM 507
1D255-20-12	+	M30 x 2	20	3/4	3.19	81	1.30	33	36	PUM 510
1D255-25-12	+	M36 x 2	25	3/4	3.27	83	1.38	35	41	PUM 511
1D255-30-16 (+)	+	M42 x 2	30	1	3.90	99	1.38	35	46	PUM 512

11D55 Metric Standpipe Light Series

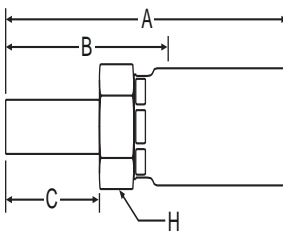

55 Series Permanent

Steel Part Number	C	O.D.	I.D.	A		Cutoff Allow. B		C		H Hex	Pusher Number
				inch	mm	inch	mm	inch	mm		
#											
Hose Fitting			inch	inch	mm	inch	mm	inch	mm	mm	
11D55-6-3	+	6	3/16	2.28	58	1.26	32	0.79	20	14	PUM 501
11D55-8-4	+	8	1/4	2.60	66	1.42	36	0.87	22	17	PUM 502
11D55-10-5	+	10	5/16	2.76	70	1.46	37	0.91	23	17	PUM 502
11D55-10-6	+	10	3/8	2.95	75	1.46	37	0.91	23	19	PUM 502
11D55-12-6	+	12	3/8	2.95	75	1.50	38	0.91	23	19	PUM 503
11D55-15-8	+	15	1/2	3.23	82	1.61	41	0.98	25	22	PUM 504
11D55-18-12	+	18	3/4	3.23	82	1.54	39	0.98	25	30	PUM 508
11D55-22-12	+	22	3/4	3.66	93	1.77	45	1.10	28	30	PUM 508
11D55-28-16	+	28	1	4.17	106	1.85	47	1.18	30	41	PUM 511

(+) Non Standard. See page ii for information on non-standard products.

1D955 Male BSPP

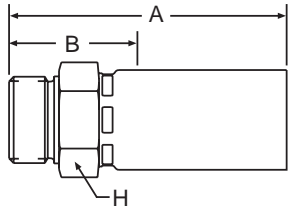

55 Series Permanent

Steel Part Number	C	Thread Size	Hose I.D.	A		Cutoff Allow. B		H Hex	Pusher Number
				inch	mm	inch	mm		
#									
Hose Fitting			inch	inch	mm	inch	mm	mm	
1D955-4-4 (+)	+	PT 1/4-19	1/4	2.24	57	1.02	26	19	PUM 503
1D955-6-5 (+)	+	PF 3/8-19	5/16	2.36	60	1.06	27	22	PUM 504
1D955-6-6	+	PT 3/8-19	3/8	2.52	64	1.06	27	22	PUM 504
1D955-8-8	+	PT 1/2-14	1/2	2.87	73	1.22	31	27	PUM 506
1D955-12-12	+	PT 3/4-14	3/4	3.19	81	1.34	34	36	PUM 509
1D955-16-16 (+)	+	PT 1-11	1	3.74	95	1.38	35	41	PUM 511

13D55 Metric Standpipe Heavy Series

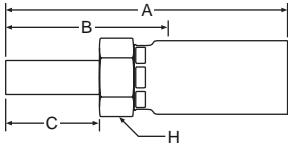

55 Series Permanent

Steel Part Number	C	Tube O.D.	Hose I.D.	A		Cutoff Allow. B		C		H Hex	Pusher Number
				inch	mm	inch	mm	inch	mm		
#											
Hose Fitting			inch	inch	mm	inch	mm	inch	mm	mm	
13D55-8-3	+	8	3/16	2.40	61	1.38	35	0.94	24	14	PUM 501
13D55-10-4	+	10	1/4	2.72	69	1.54	39	0.94	24	17	PUM 502
13D55-12-5	+	12	5/16	2.91	74	1.61	41	1.02	26	17	PUM 502
13D55-12-6	+	12	3/8	3.07	78	1.57	40	1.02	26	19	PUM 503
13D55-14-6	+	14	3/8	3.19	81	1.73	44	1.02	26	19	PUM 503
13D55-16-8	+	16	1/2	3.43	87	1.81	46	1.18	30	22	PUM 504
13D55-20-12 (+)	+	20	3/4	3.58	91	1.69	43	1.57	40	30	PUM 508
13D55-25-12 (+)	+	25	3/4	3.58	91	1.69	43	1.57	40	30	PUM 508
13D55-30-16 (+)	+	30	1	4.02	102	2.05	52	1.73	44	41	PUM 511

(+) Non Standard. See page ii for information on non-standard products.

19255 BSP Swivel Female, Ballnose

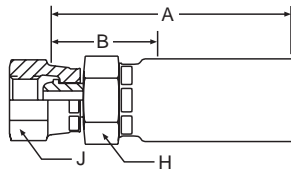

55 Series Permanent

Steel Part Number	C	Thread Size	Hose I.D.	A		Cutoff Allow. B		H Hex	J Hex	Pusher Number
				inch	mm	inch	mm	mm	mm	
#										
Hose Fitting			inch	inch	mm	inch	mm	mm	mm	
19255-4-3	+	PF 1/4-19	3/16	1.73	44	1.10	28	17	19	PUF 013
19255-4-4	+	PF 1/4-19	1/4	2.24	57	1.02	26	17	19	PUF 013
19255-6-5	+	PF 3/8-19	5/16	2.36	60	1.06	27	19	22	PUF 305
19255-6-6	+	PF 3/8-19	3/8	2.56	65	1.06	27	19	22	PUF 306
19255-8-8	+	PF 1/2-14	1/2	2.91	74	1.22	31	24	27	PUF 308
19255-10-8	+	PF 5/8-14	1/2	3.27	83	1.34	34	27	30	PUF 008
19255-12-12	+	PF 3/4-14	3/4	3.27	83	1.38	35	32	32	PUF 008
19255-12-16	+	PF 1-11	1	3.86	98	1.54	39	36	41	PUF 508

1B155 BSP Female Swivel 45° Elbow, Ballnose

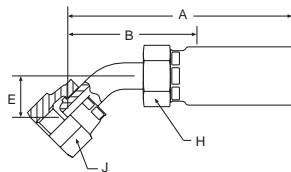

55 Series Permanent

Steel Part Number	C	Thread Size	Tube O.D.	Hose I.D.	A		Cutoff Allow. B		E		H Hex	J Hex	Pusher Number
					inch	mm	inch	mm	inch	mm	mm	mm	
#													
Hose Fitting				inch	inch	mm	inch	mm	inch	mm	mm	mm	
1B155-4-4	+	PF 1/4-19	1/4	1/4	2.76	70	1.54	39	0.55	14	17	19	PUT 002
1B155-6-5 (+)	+	PF 3/8-19	3/8	5/16	2.91	74	1.61	41	0.55	16	17	22	PUT 002
1B155-6-6	+	PF 3/8-19	3/8	3/8	3.11	79	1.61	41	0.63	16	19	22	PUT 003
1B155-8-8	+	PF 1/2-14	1/2	1/2	3.54	90	1.85	47	0.63	17	22	27	PUT 008
1B155-10-8 (+)	+	PF 5/8-14	1/2	1/2	3.58	91	1.89	48	0.67	17	22	30	PUT 008
1B155-12-12 (+)	+	PF 3/4-14	3/4	3/4	4.09	104	2.20	56	0.67	22	30	32	PUT 005
1B155-16-16 (+)	+	PF1-11	1	1	4.80	122	2.48	63	0.87	25	38	41	PUT 007

(+) Non Standard. See page ii for information on non-standard products.

PTFE Hose & Fittings

Thermoplastic Tubing

Coiled Air Hose, Fittings & Accessories

Truck (Fleet) Products

Tooling & Equipment

Hose Accessories

Technical & Design Information

Approvals & Guides

Alphanumeric Index

1B255 BSP Female Swivel 90° Elbow, Ballnose

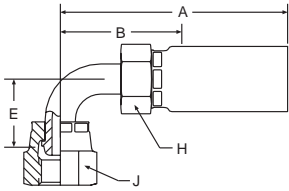

55 Series Permanent

Steel Part Number	C	Thread Size	Tube O.D.	Hose I.D.	A		Cutoff Allow. B		E		H Hex	J Hex	Pusher Number
					inch	mm	inch	mm	inch	mm	mm	mm	
#													
Hose Fitting				inch	inch	mm	inch	mm	inch	mm	mm	mm	
1B255-4-4	+	PF 1/4-19	1/4	1/4	2.48	63	1.26	32	1.14	29	17	19	PUT 002
1B255-6-5 (+)	+	PF 3/8-19	3/8	5/16	2.72	69	1.42	35	1.34	34	17	22	PUT 002
1B255-6-6	+	PF 3/8-19	3/8	3/8	2.95	75	1.46	37	1.50	38	19	22	PUT 003
1B255-8-8	+	PF 1/2-14	1/2	1/2	3.27	83	1.57	40	1.57	40	22	27	PUT 008
1B255-10-8 (+)	+	PF 5/8-14	1/2	1/2	3.27	83	1.57	40	1.54	39	22	30	PUT 005
1B255-12-12 (+)	+	PF 3/4-14	3/4	3/4	3.94	100	2.05	52	2.20	56	30	32	PUT 005
1B255-16-16 (+)	+	PF1-11	1	1	4.69	119	2.36	60	2.28	58	38	41	PUT 007

(+) Non Standard. See page ii for information on non-standard products.

10158/10158H Male Taper Pipe Rigid

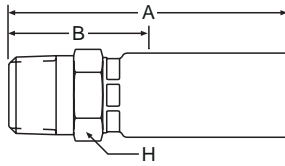

58/58H Series Permanent

Steel Part Number	B	C	NPTF Pipe Thread	Hose I.D.	A		Cutoff Allow. B		H Hex	Pusher Number
					inch	mm	inch	mm		
#										
Hose Fitting				inch	inch	mm	inch	mm	inch	
10158-2-4	+	+	1/8-27	1/4	2.13	54	1	25	5/8	PUM 001
10158-4-4	+	+	1/4-18	1/4	2.31	59	1.19	30	11/16	PUM 004
10158-4-5 (+)	+	+	1/4-18	5/16	2.37	60	1.19	30	11/16	PUM 004
10158-4-6	+	+	1/4-18	3/8	2.66	68	1.31	33	3/4	PUM 005
10158-6-4	+	+	3/8-18	1/4	2.41	61	1.31	33	3/4	PUM 005
10158-6-5 (+)	+	+	3/8-18	5/16	2.47	63	1.31	33	3/4	PUM 005
10158-6-6	+	+	3/8-18	3/8	2.66	68	1.31	33	3/4	PUM 005
10158-6-8	+	+	3/8-18	1/4	2.85	72	1.31	33	7/8	PUM 008
10158-8-6	+	+	1/2-14	3/8	2.91	74	1.56	40	15/16	PUM 009
10158-8-8	+	+	1/2-14	1/2	3.09	78	1.56	40	15/16	PUM 009
10158-8-10	+	+	1/2-14	5/8	3.20	81	1.50	38	1	PUM 009
10158-12-10 (+)	+	+	3/4-14	5/8	3.20	81	1.56	40	1-1/8	PUM 011
10158-12-12	+	+	3/4-14	3/4	3.28	83	1.56	40	1-1/8	PUM 011
10158-16-16	+	+	1-11-1/2	1	3.96	101	1.75	44	1-3/8	PUM 013
10158H-12-12	+	+	3/4-14	3/4	3.91	99	1.69	43	1-1/4	Crimp Only
10158H-12-16 (+)	+	+	3/4-14	1	4.58	116	1.50	38	1-1/4	Crimp Only
10158H-16-16	+	+	1-11-1/2	1	4.76	121	1.81	46	1-3/4	Crimp Only

10258 Female Taper Pipe Rigid

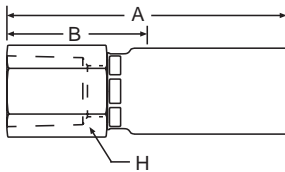

58 Series Permanent

Steel Part Number	B	C	NPTF Pipe Thread	Hose I.D.	A		Cutoff Allow. B		H Hex	Pusher Number
					inch	mm	inch	mm		
#										
Hose Fitting				inch	inch	mm	inch	mm	inch	
10258-4-4	+	+	1/4-18	1/4	2.37	60	1.25	32	3/4	PUF 002
10258-6-4 (+)	+	+	3/8-18	1/4	2.58	66	1.50	38	7/8	PUF 005
10258-6-6	+	+	3/8-18	3/8	2.77	70	1.50	38	7/8	PUF 005
10258-8-6 (+)	+	+	1/2-14	3/8	2.68	68	1.38	35	1-1/16	PUF 007
10258-8-8	+	+	1/2-14	1/2	2.87	73	1.38	35	1-1/16	PUF 007

(+) Non Standard. See page ii for information on non-standard products.

10358 Male (JIC) 37°

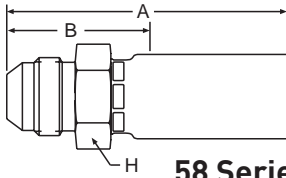

58 Series Permanent

Steel Part Number	B	C	Thread Size	Tube O.D.	Hose I.D.	A		Cutoff Allow. B		H Hex	Pusher Number
						inch	mm	inch	mm		
#											
Hose Fitting				inch	inch	inch	mm	inch	mm	inch	
10358-4-4 (+)	+	+	7/16-20	1/4	1/4	2.30	58	1.19	30	5/8	PUM 002
10358-5-4 (+)	+	+	1/2-20	5/16	1/4	2.31	59	1.19	30	5/8	PUM 002
10358-5-5 (+)	+	+	1/2-20	5/16	5/16	2.32	59	1.19	30	5/8	PUM 002
10358-6-4 (+)	+	+	9/16-18	3/8	1/4	2.33	59	1.19	30	11/16	PUM 004
10358-6-5 (+)	+	+	9/16-18	3/8	5/16	2.34	59	1.19	30	11/16	PUM 004
10358-6-6	+	+	9/16-18	3/8	3/8	2.58	66	1.28	33	3/4	PUM 005
10358-8-6	+	+	3/4-16	1/2	3/8	2.68	68	1.38	35	13/16	PUM 007
10358-8-8	+	+	3/4-16	1/2	1/2	2.87	73	1.38	35	7/8	PUM 008
10358-8-10	+	+	3/4-16	1/2	5/8	3.05	77	1.38	35	7/8	PUM 008
10358-10-8	+	+	7/8-14	5/8	1/2	3.03	77	1.56	40	15/16	PUM 009
10358-10-10	+	+	7/8-14	5/8	5/8	3.20	81	1.56	40	1	PUM 014
10358-12-8 (+)	+	+	1-1/16-12	3/4	1/2	3.14	80	1.66	42	1-1/8	PUM 011
10358-12-10	+	+	1-1/16-12	3/4	5/8	3.30	84	1.63	41	1-1/8	PUM 011
10358-12-12	+	+	1-1/16-12	3/4	3/4	3.32	84	1.66	42	1-1/8	PUM 011
10358-16-16	+	+	1-5/16-12	1	1	3.93	100	1.72	44	1-3/8	PUM 013

13E58 Male (JIC) 37° Long

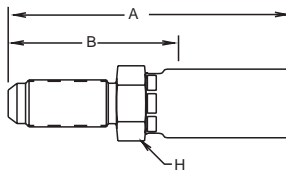

58 Series Permanent

Steel Part Number	B	C	Thread Size	Tube O.D.	Hose I.D.	A		Cutoff Allow. B		H Hex	Pusher Number
						inch	mm	inch	mm		
#											
Hose Fitting				inch	inch	inch	mm	inch	mm	inch	
13E58-10-10 (+)	+	+	7/8-14	5/8	5/8	4.03	102	1.25	57	1-1/8	PUM 014L
13E58-12-12 (+)	+	+	1-1/16-12	3/4	3/4	4.29	109	1.44	62	1-3/8	PUM 011L

(+) Non Standard. See page ii for information on non-standard products.

10458 Male SAE 45°

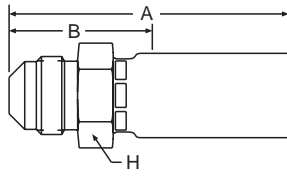

58 Series Permanent

Steel Part Number	B	C	Thread Size	Tube O.D.	Hose I.D.	A		Cutoff Allow. B		H Hex	Pusher Number
						inch	mm	inch	mm		
#											
Hose Fitting				inch	inch	inch	mm	inch	mm	inch	
10458-5-4 (+)	+	+	1/2-20	5/16	1/4	2.31	59	1.19	30	5/8	PUM 002
10458-6-5 (+)	+	+	5/8-18	3/8	5/16	2.46	62	1.34	34	3/4	PUM 005
10458-6-6	+	+	5/8-18	3/8	3/8	2.65	67	1.34	34	3/4	PUM 005
10458-6-8 (+)	+	+	5/8-18	3/8	1/2	2.83	72	1.34	34	7/8	PUM 005
10458-8-8	+	+	3/4-16	1/2	1/2	2.96	75	1.47	37	7/8	PUM 008
10458-12-12	+	+	1-1/16-14	3/4	3/4	3.46	88	1.78	45	1-1/8	PUM 011

10558 Straight Thread O-Ring

(Buna N O-Ring Included)

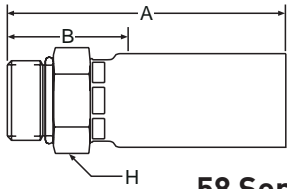

58 Series Permanent

Steel Part Number	B	C	Thread Size	Tube O.D.	Hose I.D.	A		Cutoff Allow. B		H Hex	Pusher Number
						inch	mm	inch	mm		
#											
Hose Fitting				inch	inch	inch	mm	inch	mm	inch	
10558-4-4 (+)	+	+	7/16-20	1/4	1/4	2.11	54	1	25	5/8	PUF 021
10558-4-5 (+)	+	+	7/16-20	1/4	5/16	2.11	54	1	25	5/8	PUF 021
10558-5-4 (+)	+	+	1/2-20	5/16	1/4	2.11	54	1	25	5/8	PUF 021
10558-5-5 (+)	+	+	1/2-20	5/16	5/16	2.11	54	1	25	5/8	PUF 021
10558-6-4	+	+	9/16-18	3/8	1/4	2.14	54	1.06	27	11/16	PUF 022
10558-6-6	+	+	9/16-18	3/8	3/8	2.42	61	1.19	30	3/4	PUF 023
10558-8-6 (+)	+	+	3/4-16	1/2	3/8	2.46	62	1.19	30	7/8	PUF 024
10558-8-8	+	+	3/4-16	1/2	1/2	2.65	67	1.19	30	7/8	PUF 024
10558-10-8	+	+	7/8-14	5/8	1/2	2.77	70	1.31	33	1	PUF 019
10558-12-10 (+)	+	+	1-1/16-12	3/4	5/8	2.95	75	1.19	30	1-1/4	PUF 019

(+) Non Standard. See page ii for information on non-standard products.

PTFE Hose & Fittings

Thermoplastic Tubing

Coiled Air Hose, Fittings & Accessories

Truck (Fleet) Products

Tooling & Equipment

Hose Accessories

Technical & Design Information

Approvals & Guides

Alphanumeric Index

10658/10658H SAE (JIC) 37° Swivel

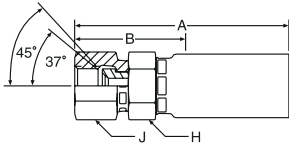

58/58H Series Permanent

Steel Part Number	B	C	Thread Size	Tube O.D.	Hose I.D.	A		Cutoff Allow. B		H Hex	J Hex	Pusher Number
						inch	mm	inch	mm			
#												
Hose Fitting				inch	inch	inch	mm	inch	mm	inch	inch	
10658-4-4	+	+	7/16-20	1/4	1/4	2.50	64	1.38	35	5/8	5/8	PUF 010
10658-5-4 (+)	+	+	1/2-20	5/16	1/4	2.50	64	1.38	35	5/8	3/4	PUF 013
10658-6-4	+	+	9/16-18	3/8	1/4	2.50	64	1.38	35	5/8	3/4	PUF 013
10658-5-5	+	+	1/2-20	5/16	5/16	2.50	64	1.38	35	5/8	3/4	PUF 013
10658-6-5	+	+	9/16-18	3/8	5/16	2.50	64	1.38	35	5/8	3/4	PUF 013
10658-6-6	+		9/16-18	3/8	3/8	2.78	71	1.50	38	3/4	3/4	PUF 015
10658-8-6	+	+	3/4-16	1/2	3/8	2.78	71	1.44	37	3/4	15/16	PUF 005
10658-6-8 (+)	+	+	9/16-18	3/8	1/2	2.96	75	1.44	37	7/8	3/4	PUF 015
10658-8-8	+		3/4-16	1/2	1/2	3.12	79	1.63	41	15/16	15/16	PUF 016
10658-8-10	+	+	3/4-16	1/2	5/8	3.30	84	1.63	41	1	15/16	PUF 005
10658-10-8	+		7/8-14	5/8	1/2	3.12	79	1.63	41	15/16	1-1/16	PUF 006
10658-10-10	+	+	7/8-14	5/8	5/8	3.28	83	1.50	38	1	1-1/16	PUF 006
10658-10-12	+	+	7/8-14	5/8	3/4	3.36	85	1.69	43	1-1/8	1-1/16	PUF 006
10658-12-8	+	+	1-1/16-12	3/4	1/2	3.21	82	1.75	44	1-1/4	1-1/4	PUF 008
10658-12-10	+	+	1-1/16-12	3/4	5/8	3.40	86	1.75	44	1-1/8	1-1/4	PUF 006
10658-12-12	+	+	1-1/16-12	3/4	3/4	3.40	86	1.75	44	1-1/8	1-1/4	PUF 008
10658-16-12 (+)	+	+	1-5/16-12	1	3/4	3.55	90	1.81	46	1-3/8	1-1/2	PUF 009
10658-16-16	+	+	1-5/16-12	1	1	4.02	102	1.75	44	1-3/8	1-1/2	PUF 009
10658H-8-12 (+)	+	+	3/4-16	1/2	3/4	3.95	100	1.63	41	1-1/4	15/16	Crimp Only
10658H-12-12	+	+	1-1/16-12	3/4	3/4	4.14	105	1.81	46	1-1/4	1-5/16	Crimp Only
10658H-16-16	+		1-5/16-12	1	1	4.89	124	1.94	49	1-3/4	1-5/8	Crimp Only

*316 stainless nipple, nut, shell

(+) Non Standard. See page ii for information on non-standard products.

10758 Female Pipe Swivel

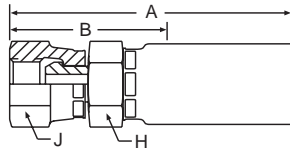

58 Series Permanent

Steel Part Number	B	C	Thread Size	Tube O.D.	Hose I.D.	A		Cutoff Allow. B		H Hex	J Hex	Pusher Number
						inch	mm	inch	mm			
#												
Hose Fitting				inch	inch	inch	mm	inch	mm	inch	inch	
10758-4-4	+	+	1/4-18	1/4	1/4	2.37	60	1.25	32	5/8	3/4	PUF 002
10758-4-5 (+)	+	+	1/4-18	1/4	5/16	2.50	64	1.38	35	3/4	3/4	PUF 013
10758-6-6	+	+	3/8-18	3/8	3/8	2.63	67	1.38	35	7/8	7/8	PUF 004
10758-8-8	+	+	1/2-14	1/2	1/2	2.97	75	1.50	38	1	1	PUF 018
10758-12-12	+	+	3/4-14	3/4	3/4	3.48	88	1.75	44	1-1/8	1-1/4	PUF 008
10758-16-16	+	+	1-11-1/2	1	1	4.00	102	1.81	46	1-3/8	1-1/2	PUF 009

10858 SAE 45° Swivel

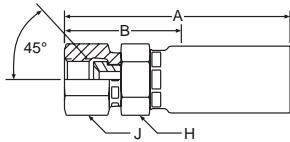

58 Series Permanent

Steel Part Number	B	C	Thread Size	Tube O.D.	Hose I.D.	A		Cutoff Allow. B		H Hex	J Hex	Pusher Number
						inch	mm	inch	mm			
#												
Hose Fitting				inch	inch	inch	mm	inch	mm	inch	inch	
10858-6-4 (+)	+	+	5/8-18	3/8	1/4	2.50	64	1.38	35	5/8	13/16	PUF 003
10858-6-5 (+)	+	+	5/8-18	3/8	5/16	2.50	64	1.38	35	5/8	13/16	PUF 003
10858-6-6	+	+	5/8-18	3/8	3/8	2.78	71	1.50	38	3/4	13/16	PUF 014
10858-12-12	+	+	1-1/16-14	3/4	3/4	3.40	86	1.69	43	1-1/8	1-1/4	PUF 008

(+) Non Standard. See page ii for information on non-standard products.

PTFE Hose & Fittings

Thermoplastic Tubing

Coiled Air Hose, Fittings & Accessories

Truck (Fleet) Products

Tooling & Equipment

Hose Accessories

Technical & Design Information

Approvals & Guides

Alphanumeric Index

11158 Ferrul-Fix

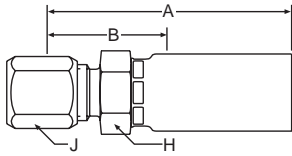

58 Series Permanent

Steel Part Number	B	C	Thread Size	Tube O.D.	Hose I.D.	A		Cutoff Allow. B		H Hex	J Hex	Pusher Number
						inch	mm	inch	mm			
#												
Hose Fitting				inch	inch	inch	mm	inch	mm	inch	inch	
11158-6-4 (+)	+	+	9/16-18	3/8	1/4	2.34	59	1.25	32	11/16	11/16	PUF 015
11158-6-6 (+)	+	+	9/16-18	3/8	3/8	2.53	64	1.25	32	3/4	11/16	PUF 015
11158-8-6 (+)	+	+	3/4-16	1/2	3/8	2.62	67	1.31	33	7/8	7/8	PUF 016
11158-8-8 (+)	+	+	3/4-16	1/2	1/2	2.82	72	1.38	35	7/8	7/8	PUF 016
11158-10-6 (+)	+	+	7/8-14	5/8	3/8	3.68	93	1.38	35	1	1	PUF 017
11158-10-8	+	+	7/8-14	5/8	1/2	2.88	73	1.44	37	1	1	PUF 017

NOTE: Nut Part Number is 111 - size
Sleeve Part Number is 110-size

11258 SAE Flareless Swivel

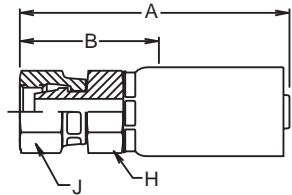

58 Series Permanent

Steel Part Number	B	C	Thread Size	Tube O.D.	Hose I.D.	A		Cutoff Allow. B		H Hex	J Hex	Pusher Number
						inch	mm	inch	mm			
#												
Hose Fitting				inch	inch	inch	mm	inch	mm	inch	inch	
11258-6-4 (+)	+	+	9/16-18	3/8	1/4	2.57	65	1.44	37	11/16	3/4	PUF 015
11258-6-6 (+)	+	+	9/16-18	3/8	3/8	2.76	70	1.44	37	3/4	3/4	PUF 015
11258-8-6 (+)	+	+	3/4-16	1/2	3/8	2.86	72	1.56	40	7/8	15/16	PUF 025
11258-8-8 (+)	+	+	3/4-16	1/2	1/2	3.05	77	1.06	27	7/8	15/16	PUF 025
11258-10-8 (+)	+	+	7/8-14	5/8	1/2	3.16	80	1.69	43	1	1-1/16	PUF 026
11258-12-12 (+)	+	+	1-1/16-12	3/4	3/4	3.48	88	1.75	44	1-1/4	1-1/4	PUF 027

(+) Non Standard. See page ii for information on non-standard products.



11358/ Male Pipe Swivel*

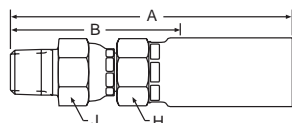

58/58H Series Permanent

Steel Part Number	B	C	Thread Size	Tube O.D.	Hose I.D.	A		Cutoff Allow. B		H Hex	J Hex	Pusher Number
						inch	mm	inch	mm			
#												
Hose Fitting				inch	inch	inch	mm	inch	mm	inch	inch	
11358-4-4	+	+	1/4-18	1/4	1/4	2.84	72	1.69	43	5/8	11/16	PUM 003
11358-4-5 (+)	+	+	1/4-18	1/4	5/16	2.84	72	1.69	43	5/8	11/16	PUM 003
11358-6-6	+	+	3/8-18	3/8	3/8	3.12	79	1.81	46	3/4	3/4	PUM 006
11358-8-6 (+)	+	+	1/2-14	1/2	3/8	3.37	86	2.06	52	3/4	15/16	PUM 010
11358-8-8	+	+	1/2-14	1/2	1/2	3.56	90	2.06	52	7/8	15/16	PUM 010
11358-12-12	+	+	3/4-14	3/4	3/4	3.81	97	2.13	54	1-1/8	1-1/8	PUM 012
11358-16-16	+	+	1-11-1/2	1	1	5.06	129	2.81	71	1-1/2	1-1/2	PUM 030

*For use with petroleum based fluids with o-ring supplied.

WARNING: Fittings allow minor movement to relieve stress on hose but are not recommended for continued or extensive swiveling. Fittings not recommended for use in CNG applications.

11L58 Male Pipe Swivel 90° Elbow*

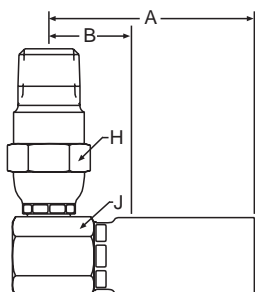

58 Series Permanent

Steel Part Number	B	C	Thread Size	Hose I.D.	A		Cutoff Allow. B		H Hex	J Hex	Pusher Number
					inch	mm	inch	mm			
#											
Hose Fitting				inch	inch	mm	inch	mm	inch	inch	
11L58-4-4 (+)	+	+	1/4-18	1/4	1.94	49	0.81	21	11/16	11/16	PUS 001

*For use with petroleum based fluids.

WARNING: Fittings allow minor movement under pressure to relieve stress on hose but are not recommended for continued or extensive swiveling. Fittings not recommended for use in CNG applications.

Note: Use Crimp Die Ring 80C-R1L with ParKrimp 1 Machine; Crimp Die Ring 82C-R1L with KarryKrimp.

Consult factory for ordering information.

(+) Non Standard. See page ii for information on non-standard products.

PTFE Hose & Fittings

Thermoplastic Tubing

Coiled Air Hose, Fittings & Accessories

Truck (Fleet) Products

Tooling & Equipment

Hose Accessories

Technical & Design Information

Approvals & Guides

Alphanumeric Index

13758/13758H Female SAE (JIC) 37° Swivel 45° Elbow

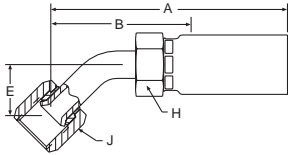

58/58H Series Permanent (SAE Drop Dimensions)

Steel Part Number	B	C	Thread Size	Tube O.D.	Hose I.D.	A		Cutoff Allow. B		E		H Hex	J Hex	Pusher Number
						inch	mm	inch	mm	inch	mm	inch	inch	
#														
Hose Fitting				inch	inch	inch	mm	inch	mm	inch	mm	inch	inch	
13758-4-4 (+)	+	+	7/16-20	1/4	1/4	2.49	63	1.50	38	0.33	8	5/8	9/16	PUT 002
13758-5-4 (+)	+	+	1/2-20	5/16	1/4	2.49	63	1.50	38	0.36	9	5/8	5/8	PUT 002
13758-6-5 (+)	+	+	9/16-18	3/8	5/16	2.73	69	1.56	40	0.39	10	5/8	11/16	PUT 002
13758-6-6	+	+	9/16-18	3/8	3/8	2.91	74	1.56	40	0.39	10	3/4	11/16	PUT 003
13758-8-6	+	+	3/4-16	1/2	3/8	3.18	81	1.88	48	0.55	14	3/4	7/8	PUT 003
13758-8-8	+	+	3/4-16	1/2	1/2	3.37	86	1.88	48	0.55	14	7/8	7/8	PUT 004
13758-10-8	+	+	7/8-14	5/8	1/2	3.42	87	1.94	49	0.63	16	7/8	1	PUT 004
13758-10-10	+	+	7/8-14	5/8	5/8	3.44	87	1.75	44	0.64	16	1-1/16	1	PUT 004
13758-12-12	+	+	1-1/16-12	3/4	3/4	4.05	103	2.39	60	0.78	20	1-1/8	1-1/4	PUT 005
13758-16-16	+	+	1-5/16-12	1	1	4.57	116	2.31	59	0.89	23	1-1/2	1-3/8	PUT 007
13758H-12-12 (+)	+	+	1-1/16-12	3/4	3/4	4.64	118	2.44	62	0.78	20	1-1/4	1-1/4	Crimp Only
13758H-16-16	+	+	1-5/16-12	1	1	5.46	139	2.50	64	0.90	23	1-3/4	1-1/2	Crimp Only

(+) Non Standard. See page ii for information on non-standard products.

13958/13958H Female SAE (JIC) 37° Swivel - 90° Elbow

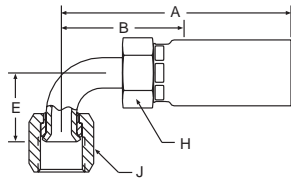

58/58H Series Permanent (SAE Drop Dimensions)

Steel Part Number	B	C	Thread Size	Tube O.D.	Hose I.D.	A		Cutoff Allow. B		E		H Hex	J Hex	Pusher Number
						inch	mm	inch	mm	inch	mm	inch	inch	
#														
Hose Fitting				inch	inch	inch	mm	inch	mm	inch	mm	inch	inch	
13958-4-4 (+)	+	+	7/16-20	1/4	1/4	2.50	64	1.38	35	0.68	17	5/8	9/16	PUT 002
13958-5-4 (+)	+	+	1/2-20	5/16	1/4	2.67	68	1.56	40	0.77	20	5/8	5/8	PUT 002
13958-6-5 (+)	+	+	9/16-18	3/8	5/16	2.63	67	1.50	38	0.85	22	5/8	11/16	PUT 002
13958-6-6	+	+	9/16-18	3/8	3/8	2.81	71	1.50	38	0.85	22	3/4	11/16	PUT 003
13958-8-6 (+)	+	+	3/4-16	1/2	3/8	2.94	75	1.63	41	1.09	28	3/4	7/8	PUT 003
13958-8-8	+	+	3/4-16	1/2	1/2	3.13	80	1.63	41	1.09	28	7/8	7/8	PUT 004
13958-10-8 (+)	+	+	7/8-14	5/8	1/2	3.27	83	1.75	44	1.23	31	7/8	1	PUT 004
13958-10-10	+	+	7/8-14	5/8	5/8	3.28	83	1.63	41	1.23	31	1-1/16	1	PUT 004
13958-12-12	+	+	1-1/16-12	3/4	3/4	3.97	101	2.25	57	1.81	46	1-1/8	1-1/4	PUT 005
13958-16-16	+	+	1-5/16-12	1	1	4.77	121	2.56	65	2.14	54	1-3/8	1-1/2	PUT 007
13958H-12-12	+	+	1-1/16-12	3/4	3/4	4.57	116	2.38	60	1.81	46	1-1/4	1-1/4	Crimp Only
13958H-16-16 (+)	+	+	1-5/16-12	1	1	5.42	138	2.50	64	2.14	54	1-3/4	1-1/2	Crimp Only

(+) Non Standard. See page ii for information on non-standard products.

PTFE Hose & Fittings

Thermoplastic Tubing

Coiled Air Hose, Fittings & Accessories

Truck (Fleet) Products

Tooling & Equipment

Hose Accessories

Technical & Design Information

Approvals & Guides

Alphanumeric Index

1L958 Female (JIC) 37° Swivel 90° Elbow Special

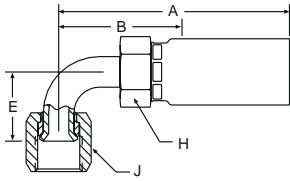

58 Series Permanent

Steel Part Number	B	C	Thread Size	Tube O.D.	Hose I.D.	A		Cutoff Allow. B		E		H Hex	J Hex	Pusher Number
						inch	mm	inch	mm	inch	mm	inch	inch	
#														
Hose Fitting				inch	inch	inch	mm	inch	mm	inch	mm	inch	inch	
1L958-4-4 (+)	+	+	7/16-20	1/4	1/4	2.47	63	1.38	35	0.88	22	5/8	9/16	PUT 002
1L958-5-4 (+)	+	+	1/2-20	5/16	1/4	2.53	64	1.44	37	0.88	22	5/8	5/8	PUT 002
1L958-6-5 (+)	+	+	9/16-18	3/8	5/16	2.69	68	1.50	38	1.12	28	5/8	11/16	PUT 002
1L958-6-6	+	+	9/16-18	3/8	3/8	2.88	73	1.50	38	1.12	28	3/4	13/16	PUT 003
1L958-8-6	+	+	3/4-16	1/2	3/8	3.00	76	1.63	41	1.38	35	3/4	7/8	PUT 003
1L958-8-8	+	+	3/4-16	1/2	1/2	3.19	81	1.63	41	1.38	35	7/8	7/8	PUT 004
1L958-10-8	+	+	7/8-14	5/8	1/2	3.68	93	2.13	54	1.75	44	7/8	1	PUT 004
1L958-12-12	+	+	1-1/16-12	3/4	3/4	4.29	109	2.56	65	2.06	52	1-1/8	1-1/4	PUT 005
1L958-16-16	+	+	1-5/16-12	1	1	5.14	131	2.88	73	2.50	64	1-3/8	1-1/2	PUT 007

(+) Non Standard. See page ii for information on non-standard products.

14158 Female SAE (JIC) 37° Swivel 90° Long Elbow

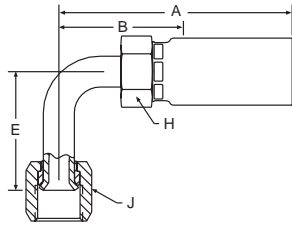

58 Series Permanent (SAE Drop Dimensions)

Steel Part Number	B	C	Thread Size	Tube O.D.	Hose I.D.	A		Cutoff Allow. B		E		H Hex	J Hex	Pusher Number
						inch	mm	inch	mm	inch	mm	inch	inch	
#														
Hose Fitting				inch	inch	inch	mm	inch	mm	inch	mm	inch	inch	
14158-4-4 (+)	+	+	7/16-20	1/4	1/4	2.57	65	1.44	37	1.80	46	5/8	9/16	PUT 002
14158-5-4 (+)	+	+	1/2-20	5/16	1/4	2.51	64	1.38	35	1.80	46	5/8	5/8	PUT 002
14158-6-5 (+)	+	+	9/16-18	3/8	5/16	2.73	69	1.56	40	2.18	55	5/8	11/16	PUT 002
14158-6-6	+	+	9/16-18	3/8	3/8	2.92	74	1.56	40	2.18	55	3/4	11/16	PUT 003
14158-8-6	+	+	3/4-16	1/2	3/8	3.00	76	1.75	44	2.43	62	3/4	7/8	PUT 003
14158-8-8	+	+	3/4-16	1/2	1/2	3.18	81	1.63	41	2.43	62	7/8	7/8	PUT 004
14158-10-8	+	+	7/8-14	5/8	1/2	3.39	86	1.81	46	2.57	65	7/8	1	PUT 004
14158-12-12	+	+	1-1/16-12	3/4	3/4	3.91	99	2.19	56	3.73	95	1-1/8	1-1/4	PUT 005
14158-16-16	+	+	1-5/16-12	1	1	4.62	117	2.38	60	4.33	110	1-3/8	1-1/2	PUT 007

16758 SAE Male Inverted Swivel - 45° Elbow

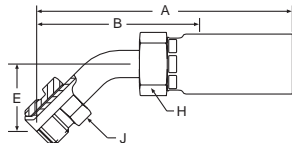

58 Series Permanent

Steel Part Number	B	C	Thread Size	Tube O.D.	Hose I.D.	A		Cutoff Allow. B		E		H Hex	J Hex	Pusher Number
						inch	mm	inch	mm	inch	mm	inch	inch	
#														
Hose Fitting				inch	inch	inch	mm	inch	mm	inch	mm	inch	inch	
16758-6-6 (+)	+	+	5/8-18	3/8	3/8	3.48	88	2.13	54	0.94	24	3/4	5/8	PUT 003

(+) Non Standard. See page ii for information on non-standard products.

PTFE Hose & Fittings

Thermoplastic Tubing

Coiled Air Hose, Fittings & Accessories

Truck (Fleet) Products

Tooling & Equipment

Hose Accessories

Technical & Design Information

Approvals & Guides

Alphanumeric Index

16958 SAE Male Inverted Swivel - 90° Elbow

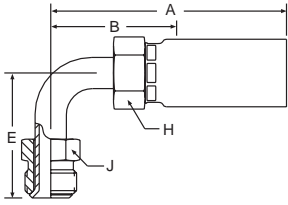

58 Series Permanent

Steel Part Number	B	C	Thread Size	Tube O.D.	Hose I.D.	A		Cutoff Allow. B		E		H Hex	J Hex	Pusher Number
						inch	mm	inch	mm	inch	mm	inch	inch	
#														
Hose Fitting				inch	inch	inch	mm	inch	mm	inch	mm	inch	inch	
16958-4-4 (+)	+	+	7/16-24	1/4	1/4	2.75	70	1.63	41	1.56	40	5/8	7/16	PUT 002
16958-6-6 (+)	+	+	5/8-18	3/8	3/8	3.08	78	1.75	44	1.69	43	3/4	5/8	PUT 003

1JS58/1JS58H Seal-Lok™ Straight

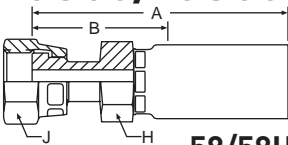

58/58H Series Permanent

Steel Part Number	C	Thread Size	Tube O.D.	Hose I.D.	A		Cutoff Allow. B		H Hex	J Hex	Pusher Number
					inch	mm	inch	mm	inch	inch	
#											
Hose Fitting			inch	inch	inch	mm	inch	mm	inch	inch	
1JS58-4-4 (+)	+	9/16-18	1/4	1/4	2.59	66	1.50	38	5/8	11/16	PUT 002
1JS58-6-4 (+)	+	11/16-16	3/8	1/4	2.58	66	1.50	38	3/4	13/16	PUT 003
1JS58-4-5 (+)	+	9/16-18	1/4	5/16	2.66	68	1.50	38	5/8	11/16	PUT 002
1JS58-6-5 (+)	+	11/16-16	3/8	5/16	2.66	68	1.50	38	3/4	13/16	PUT 003
1JS58-6-6	+	11/16-16	3/8	3/8	2.86	73	1.50	38	3/4	13/16	PUT 003
1JS58-8-6 (+)	+	13/16-16	1/2	3/8	3.00	76	1.63	41	7/8	15/16	PUT 004
1JS58-8-8	+	13/16-16	1/2	1/2	3.20	81	1.63	41	7/8	15/16	PUT 004
1JS58-10-10	+	1-14	5/8	5/8	3.53	90	1.88	48	1-1/8	1-1/8	PUT 005
1JS58-12-12	+	1-3/16-12	3/4	3/4	3.75	95	2.00	51	1-1/4	1-3/8	PUT 005
1JS58-16-16	+	1-7/16-12	1	1	4.28	109	2.06	52	1-1/2	1-5/8	PUT 015
1JS58H-12-12	+	1-3/16-12	3/4	3/4	4.29	109	2.06	52	1-1/4	1-3/8	Crimp Only
1JS58H-16-16 (+)	+	1-7/16-12	1	1	4.97	126	1.94	49	1-3/4	1-5/8	Crimp Only

(+) Non Standard. See page ii for information on non-standard products.

1JC58/1JC58H Seal-Lok™ Straight - Short

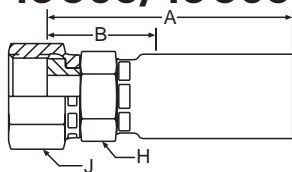

58/58H Series Permanent

Steel Part Number	C	Thread Size	Tube O.D.	Hose I.D.	A		Cutoff Allow. B		H Hex	J Hex	Pusher Number
					inch	mm	inch	mm			
#											
Hose Fitting			inch	inch	inch	mm	inch	mm	inch	inch	
1JC58-4-4	+	9/16-18	1/4	1/4	2.16	55	1.06	27	5/8	11/16	PUL 001
1JC58-6-4	+	11/16-16	3/8	1/4	2.19	56	1.09	28	3/4	13/16	PUL 002
1JC58-4-5	+	9/16-18	1/4	5/16	2.22	56	1.09	28	5/8	11/16	PUL 001
1JC58-6-5	+	11/16-16	3/8	5/16	2.28	58	1.09	28	3/4	13/16	PUL 002
1JC58-6-6	+	11/16-16	3/8	3/8	2.47	63	1.03	26	3/4	13/16	PUL 002
1JC58-8-6	+	13/16-16	1/2	3/8	2.56	65	1.19	30	7/8	15/16	PUL 003
1JC58-8-8		13/16-16	1/2	1/2	2.75	70	1.19	30	7/8	15/16	PUL 003
1JC58-10-8	+	1-14	5/8	1/2	2.95	75	1.38	35	1-1/8	1-1/8	PUL 004
1JC58-10-10	+	1-14	5/8	5/8	3.05	77	1.38	35	1-1/8	1-1/8	PUL 004
1JC58-12-10	+	1-3/16-12	3/4	5/8	3.09	78	1.43	36	1-1/4	1-3/8	PUL 006
1JC58-12-12	+	1-3/16-12	3/4	3/4	3.20	81	1.44	37	1-1/4	1-3/8	PUL 006
1JC58-16-16	+	1-7/16-12	1	1	3.74	95	1.50	38	1-1/2	1-5/8	PUL 008
1JC58-20-16	+	1-11/16-12	1-1/4	1	3.78	96	1.56	40	1-5/8	1-3/8	PUL 009
1JC58H-12-12	+	1-3/16-12	3/4	3/4	3.86	98	1.50	38	1-1/4	1-3/8	Crimp Only
1JC58H-16-16	+	1-7/16-12	1	1	4.66	119	1.69	43	1-3/4	1-5/8	Crimp Only

(+) Non Standard. See page ii for information on non-standard products.

PTFE Hose & Fittings

Thermoplastic Tubing

Coiled Air Hose, Fittings & Accessories

Truck (Fleet) Products

Tooling & Equipment

Hose Accessories

Technical & Design Information

Approvals & Guides

Alphanumeric Index

1J158/1J158H Seal-Lok™ 90° Long Elbow

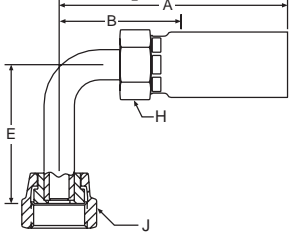

58/58H Series Permanent (SAE Drop Dimensions)

Steel Part Number	C	Thread Size	Tube O.D.	Hose I.D.	A		Cutoff Allow. B		E		H Hex	J Hex	Pusher Number
					inch	mm	inch	mm	inch	mm	inch	inch	
#													
Hose Fitting			inch	inch	inch	mm	inch	mm	inch	mm	inch	inch	
1J158-4-4 (+)	+	9/16-18	1/4	1/4	2.45	62	1.31	33	1.80	46	5/8	11/16	PUT 002
1J158-4-5 (+)	+	9/16-18	1/4	1/4	2.54	65	1.31	33	1.80	46	3/4	13/16	PUT 002
1J158-6-5 (+)	+	11/16-16	3/8	5/16	2.76	70	1.56	40	2.13	54	3/4	11/16	PUT 003
1J158-6-6 (+)	+	11/16-16	3/8	5/16	2.94	75	1.56	40	2.13	54	7/8	13/16	PUT 003
1J158-8-6 (+)	+	13/16-16	1/2	3/8	2.94	75	1.69	43	2.51	64	7/8	13/16	PUT 004
1J158-8-8 (+)	+	13/16-16	1/2	3/8	3.21	82	1.69	43	2.51	64	15/16	15/16	PUT 004
1J158-10-10	+	1-14	5/8	5/8	3.35	85	1.69	43	2.76	70	1-1/16	1-1/8	PUT 005
1J158-12-12 (+)	+	1-3/16-12	3/4	3/4	3.86	98	2.13	54	3.78	96	1-3/8	1-3/8	PUT 005
1J158-16-16 (+)	+	1-7/16-12	1	1	4.42	112	2.38	60	4.50	114	1-5/8	1-5/8	PUT 007
1J158H-12-12 (+)	+	1-3/16-12	3/4	3/4	4.38	111	1.88	48	3.78	96	1-1/4	1-3/8	Crimp Only
1J158H-16-16 (+)	+	1-7/16-12	1	1	5.35	136	2.25	57	4.50	114	1-3/4	1-5/8	Crimp Only

1J758/1J758H Seal-Lok™ 45° Elbow

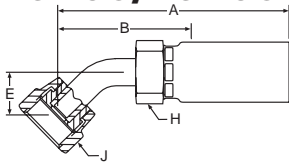

58/58H Series Permanent (SAE Drop Dimensions)

Steel Part Number	C	Thread Size	Tube O.D.	Hose I.D.	A		Cutoff Allow. B		E		H Hex	J Hex	Pusher Number
					inch	mm	inch	mm	inch	mm	inch	inch	
#													
Hose Fitting			inch	inch	inch	mm	inch	mm	inch	mm	inch	inch	
1J758-4-4 (+)	+	9/16-18	1/4	1/4	2.66	68	1.56	40	0.41	10	5/8	11/16	PUT 002
1J758-6-6	+	11/16-16	3/8	3/8	2.98	76	1.63	41	0.43	11	7/8	13/16	PUT 003
1J758-8-8	+	13/16-16	1/2	1/2	3.43	87	1.94	49	0.59	15	15/16	15/16	PUT 004
1J758-10-10	+	1-14	5/8	5/8	3.56	90	1.88	48	0.65	17	1-1/16	1-1/8	PUT 005
1J758-12-12	+	1-7/16-12	3/4	3/4	3.67	93	2.00	51	0.81	21	1-1/8	1-3/8	PUT 005
1J758-16-12	+	1-7/16-12	1	3/4	4.48	114	2.00	51	0.94	24	1-3/8	1-5/8	PUT 007
1J758-16-16	+	1-7/16-12	1	1	5.10	130	2.81	71	0.94	24	1-3/8	1-5/8	PUT 007
1J758H-12-12 (+)	+	1-3/16-12	3/4	3/4	4.51	115	2.31	59	0.81	21	1-1/4	1-3/8	Crimp Only
1J758H-16-16 (+)	+	1-7/16-12	1	1	5.75	146	2.81	71	0.94	24	1-3/4	1-5/8	Crimp Only

(+) Non Standard. See page ii for information on non-standard products.

1J958/1J958H Seal-Lok™ 90° Elbow

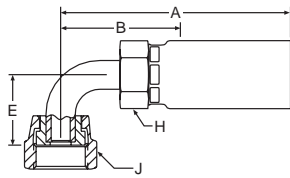

58/58H Series Permanent (SAE Drop Dimensions)

Steel Part Number	C	Thread Size	Tube O.D.	Hose I.D.	A		Cutoff Allow. B		E		H Hex	J Hex	Pusher Number
					inch	mm	inch	mm	inch	mm	inch	inch	
#													
Hose Fitting			inch	inch	inch	mm	inch	mm	inch	mm	inch	inch	
1J958-4-4 (+)	+	9/16-18	1/4	1/4	2.49	63	1.38	35	0.82	21	5/8	11/16	PUT 002
1J958-6-6	+	11/16-16	3/8	3/8	2.85	72	1.56	40	0.90	23	7/8	13/16	PUT 003
1J958-8-8	+	13/16-16	1/2	1/2	3.15	80	1.63	41	1.15	29	15/16	15/16	PUT 004
1J958-10-10	+	1-14	5/8	5/8	3.26	83	1.63	41	1.27	32	1-1/16	1	PUT 005
1J958-12-12	+	1-3/16-12	3/4	3/4	3.82	97	2.13	54	1.88	48	1-3/8	1-3/8	PUT 005
1J958-16-16	+	1-7/16-12	1	1	5.03	128	2.94	75	2.21	56	1-5/8	1-5/8	PUT 007
1J958H-12-12	+	1-3/16-12	3/4	3/4	4.41	112	2.00	51	1.85	47	1-1/4	1-3/8	Crimp Only
1J958H-16-16	+	1-7/16-12	1	1	5.70	145	2.75	70	2.21	56	1-3/4	1-5/8	Crimp Only

1J058 Male Seal-Lok™ – Rigid Straight (with O-Ring)

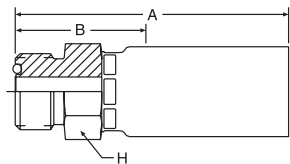

58 Series Permanent

Steel Part Number	C	Thread Size	Tube O.D.	Hose I.D.	A		Cutoff Allow. B		H Hex	Pusher Number
					inch	mm	inch	mm	inch	
#										
Hose Fitting			inch	inch	inch	mm	inch	mm	inch	
1J058-4-4 (+)	+	9/16-18	1/4	1/4	2.20	56	1.06	27	5/8	PUM 004
1J058-6-4	+	11/16-16	3/8	1/4	2.28	58	1.13	29	3/4	PUM 005
1J058-4-5	+	9/16-16	1/4	5/16	2.20	56	1.06	27	5/8	PUM 004
1J058-6-5	+	11/16-16	3/8	5/16	2.28	58	1.13	29	3/4	PUM 005
1J058-6-6 (+)	+	11/16-16	3/8	3/8	2.47	63	1.13	29	3/4	PUM 005
1J058-8-6	+	13/16-16	1/2	3/8	2.56	65	1.25	32	7/8	PUM 008
1J058-8-8 (+)	+	13/16-16	1/2	1/2	2.75	70	1.25	32	15/16	PUM 009
1J058-10-10	+	1-14	5/8	5/8	3.10	79	1.44	37	1-1/8	PUM 011
1J058-12-12	+	1-3/16-12	3/4	3/4	3.25	83	1.56	40	1-3/8	PUM 013
1J058-16-16	+	1-7/16-12	1	1	3.86	98	1.63	41	1-5/8	PUM 020

(+) Non Standard. See page ii for information on non-standard products.

PTFE Hose & Fittings

Thermoplastic Tubing

Coiled Air Hose, Fittings & Accessories

Truck (Fleet) Products

Tooling & Equipment

Hose Accessories

Technical & Design Information

Approvals & Guides

Alphanumeric Index

1TU58 Universal Tube Stub End

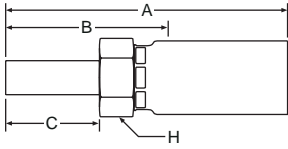

58 Series Permanent

Steel Part Number	C	Tube O.D.	Hose I.D.	A		Cutoff Allow. B		C		H Hex	Pusher Number
				inch	mm	inch	mm	inch	mm		
#											
Hose Fitting		inch	inch	inch	mm	inch	mm	inch	mm	inch	
1TU58-4-4	+	1/4	1/4	2.60	66	1.50	38	0.72	18	5/8	PUT 001
1TU58-5-5 (+)	+	5/16	5/16	2.69	68	1.50	38	0.75	19	11/16	PUT 002
1TU58-6-6	+	3/8	3/8	2.91	74	1.50	38	0.78	20	3/4	PUT 003
1TU58-8-8		1/2	1/2	3.35	85	1.81	46	1.03	26	7/8	PUT 004
1TU58-10-10 (+)	+	5/8	5/8	3.45	88	1.81	46	1.03	26	1	PUT 004
1TU58-12-12 (+)		3/4	3/4	3.66	93	1.94	49	1.03	26	1-1/8	PUT 005
1TU58-16-16 (+)		1	1	4.41	112	2.19	56	1.29	33	1-3/8	PUT 007

*316 stainless nipple, shell

1AL58N A-LOK®/CPI Compression (Without Nut and Ferrule)

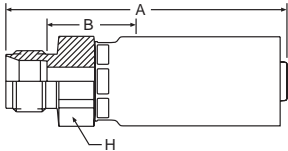

58 Series Permanent

Steel Part Number	C	Thread Size	Tube O.D.	Hose I.D.	A		Cutoff Allow. B		H Hex	Pusher Number
					inch	mm	inch	mm		
#										
Hose Fitting			inch	inch	inch	mm	inch	mm	inch	
1AL58-4-4N (+)	+	7/16-20	1/4	1/4	2.16	55	0.69	17	5/8	PUM 002
1AL58-6-6N (+)	+	9/16-20	3/8	3/8	2.56	65	0.81	21	3/4	PUM 005
1AL58-8-8N (+)	+	3/4-20	1/2	1/2	2.81	71	0.75	19	15/16	PUM 009

*316 Stainless nipple and shell.

Please reference Instrument Tubing Selection Guide, Bulletin 4200-TS, or contact the Instrumentation Connectors Division in Huntsville, Alabama, (Phone: 256-881-2040) directly for correct installation and application information.

(+) Non Standard. See page ii for information on non-standard products.

1AL58 A-LOK® Compression (With Nut and Ferrule)

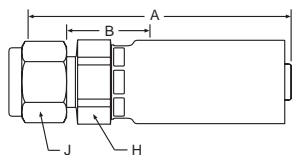

58 Series Permanent

Steel Part Number	C	Thread Size	Tube O.D.	Hose I.D.	A		Cutoff Allow. B		H Hex	J Hex	Pusher Number
					inch	mm	inch	mm			
#											
Hose Fitting			inch	inch	inch	mm	inch	mm	inch	inch	
1AL58-4-4 (+)	+	7/16-20	1/4	1/4	2.16	55	0.69	17	5/8	9/16	PUM 002
1AL58-6-6 (+)		9/16-20	3/8	3/8	2.56	65	0.81	21	3/4	11/16	PUM 005
1AL58-8-8 (+)	+	3/4-20	1/2	1/2	2.81	71	0.75	19	15/16	7/8	PUM 009

*316 Stainless nipple and shell.

Note: Nut part No. is **XNUX** or **XNUX-316** for stainless steel.

Front ferrule part No. is **XFFX** or **XFFX-316** for stainless steel.

Back ferrule part No. is **XBFX** or **XBFX-316** for stainless steel.

X denotes dash size.

Please reference Instrument Tubing Selection Guide, Bulletin 4200-TS, or contact the Instrumentation Connectors Division in Huntsville, Alabama, (Phone: 256-881-2040) directly for correct installation and application information.

1P658 CPI Compression (With Nut and Ferrule)

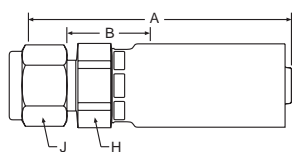

58 Series Permanent

Steel Part Number	C	Thread Size	Tube O.D.	Hose I.D.	A		Cutoff Allow. B		H Hex	J Hex	Pusher Number
					inch	mm	inch	mm			
#											
Hose Fitting			inch	inch	inch	mm	inch	mm	inch	inch	
1P658-4-4 (+)	+	7/16-20	1/4	1/4	2.16	55	0.69	17	5/8	9/16	PUM 002
1P658-6-6 (+)	+	9/16-20	3/8	3/8	2.56	65	0.81	21	3/4	11/16	PUM 005
1P658-8-8 (+)	+	3/4-20	1/2	1/2	2.81	71	0.75	19	15/16	7/8	PUM 009

*316 Stainless nipple and shell.

Note: Nut part No. is **XBZ** or **XBZ-SS** for stainless steel.

Ferrule part No. is **XTZ** or **XTZ-SS** for stainless steel.

X denotes dash size.

Please reference Instrument Tubing Selection Guide, Bulletin 4200-TS, or contact the Instrumentation Connectors Division in Huntsville, Alabama, (Phone: 256-881-2040) directly for correct installation and application information.

(+) Non Standard. See page ii for information on non-standard products.

1UT58 Male (JIS) /BSPT

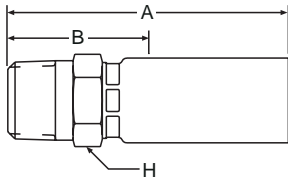

58 Series Permanent

Steel Part Number	C	BSP Thread Size	Hose I.D.	A			Cutoff Allow. B		H Hex	Pusher Number
				inch	mm	inch	mm	mm		
#										
Hose Fitting			inch	inch	mm	inch	mm	mm		
1UT58-4-4 (+)	+	PT 1/4-19	1/4	2.36	60	1.26	32	19	PUM 005	
1UT58-6-6 (+)	+	PT 3/8-19	3/8	2.38	68	1.26	32	22	PUM 008	
1UT58-8-8 (+)	+	PT 1/2-14	1/2	3.03	77	1.50	38	27	PUM 506	
1UT58-12-12 (+)	+	PT 3/4-14	3/4	3.35	85	1.57	40	35	PUM 510	
1UT58-16-16 (+)	+	PT 1-11	1	4.06	103	1.81	46	41	PUM 020	

1FU58 (JIS) /BSP 30° Flare Swivel Female

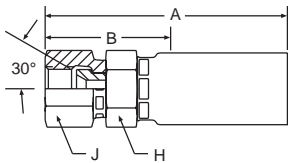

58 Series Permanent

Steel Part Number	C	BSP Thread Size	Hose I.D.	A		Cutoff Allow. B		H Hex	J Hex	Pusher Number
				inch	mm	inch	mm	mm	mm	
#										
Hose Fitting			inch	inch	mm	inch	mm	mm	mm	
1FU58-4-4 (+)	+	PF 1/4-19	1/4	2.32	59	1.26	32	19	19	PUF 002
1FU58-6-6	+	PF 3/8-19	3/8	2.68	68	1.30	33	19	22	PUF 004
1FU58-8-8 (+)	+	PF 1/2-14	1/2	3.19	81	1.61	41	27	27	PUF 006
1FU58-12-12 (+)	+	PF 3/4-14	3/4	3.54	90	1.73	44	27	36	PUF 009
1FU58-16-16 (+)	+	PF 1-11	1	4.09	104	1.89	48	41	41	PUF 030

(+) Non Standard. See page ii for information on non-standard products.

1MU58 (JIS) Metric 30° Flare Swivel Female

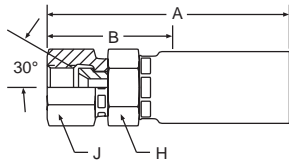

58 Series Permanent

Steel Part Number	C	Thread Size	Hose I.D.	A		Cutoff Allow. B		H Hex	J Hex	Pusher Number
				inch	mm	inch	mm	mm	mm	
#										
Hose Fitting			inch	inch	mm	inch	mm	mm	mm	
1MU58-4-4 (+)	+	M14x1,5	1/4	2.32	59	1.26	32	19	19	PUF 002
1MU58-6-6 (+)	+	M18x1,5	3/8	2.60	66	1.30	33	19	22	PUF 004
1MU58-8-8	+	M22x1,5	1/2	3.15	80	1.57	40	27	27	PUF 031
1MU58-12-12 (+)	+	M27x2,0	3/4	3.50	89	1.73	44	27	36	PUF 032
1MU58-16-16 (+)	+	M33x2,0	1	4.06	103	1.89	48	41	41	PUF 033

1GU58 (JIS) /BSP 60° Cone Swivel Female

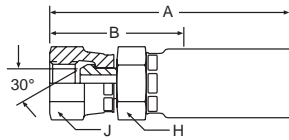

58 Series Permanent

Steel Part Number	C	BSP Thread Size	Hose I.D.	A		Cutoff Allow. B		H Hex	J Hex	Pusher Number
				inch	mm	inch	mm	mm	mm	
#										
Hose Fitting			inch	inch	mm	inch	mm	mm	mm	
1GU58-4-4 (+)	+	PF 1/4-19	1/4	2.32	59	1.26	32	19	19	PUF 002
1GU58-6-6	+	PF 3/8-19	3/8	2.76	70	1.38	35	22	22	PUF 004
1GU58-8-8 (+)	+	PF 1/2-14	1/2	1.61	41	1.61	41	27	27	PUF 006
1GU58-8-10 (+)	+	PF 1/2-14	1/2	3.27	83	1.61	41	27	27	PUF 006
1GU58-12-12 (+)	+	PF 3/4-14	3/4	1.73	44	1.73	44	27	36	PUF 009
1GU58-16-16 (+)	+	PF 1-11	1	1.89	48	1.89	48	41	41	PUF 030

(+) Non Standard. See page ii for information on non-standard products.

1G158 (JIS)/BSP 60° Cone Female Swivel 45° Elbow

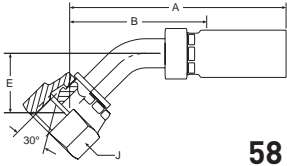

58 Series Permanent

Steel Part Number	C	BSP Thread Size	Hose I.D.	A		Cutoff Allow. B		E		J Hex	Pusher Number
				inch	mm	inch	mm	inch	mm		
#											
Hose Fitting			inch	inch	mm	inch	mm	inch	mm	inch/mm	
1G158-4-3 (+)	+	PF 1/4-19	3/16	2.83	72	1.93	49	0.85	20	9/16	PUT 001
1G158-4-4 (+)	+	PF 1/4-19	1/4	2.99	76	1.93	49	0.85	20	9/16	PUT 002
1G158-6-6 (+)	+	PF 3/8-19	3/8	3.39	86	1.89	48	0.83	21	22	PUT 003
1G158-8-8 (+)	+	PF 1/2-14	1/2	3.74	95	2.05	53	0.98	25	27	PUT 004

1G258 (JIS)/BSP 60° Cone Female Swivel 90° Elbow

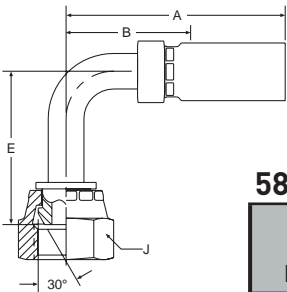

58 Series Permanent

Steel Part Number	C	BSP Thread Size	Hose I.D.	A		Cutoff Allow. B		E		J Hex	Pusher Number
				inch	mm	inch	mm	inch	mm		
#											
Hose Fitting			inch	inch	mm	inch	mm	inch	mm	mm	
1G258-4-3 (+)	+	PF 1/4-19	3/16	2.28	58	1.34	34	0.94	24	19	PUT 001
1G258-4-4 (+)	+	PF 1/4-19	1/4	2.44	62	1.34	34	0.94	24	19	PUT 002
1G258-6-6 (+)	+	PF 3/8-19	3/8	3.07	78	1.69	43	1.50	38	22	PUT 003
1G258-8-8 (+)	+	PF 1/2-14	1/2	3.31	84	1.77	45	1.81	46	27	PUT 004

(+) Non Standard. See page ii for information on non-standard products.

1C658 Metric Swivel DIN 20078 Heavy Series (Without O-Ring) 1C958 (With O-Ring)

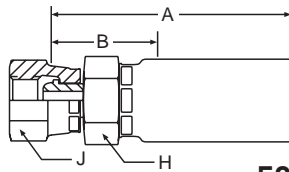

58 Series Permanent

Steel Part Number	C	Thread Size	Hose I.D.	A		Cutoff Allow. B		H Hex	J Hex	Pusher Number
				inch	mm	inch	mm	mm	mm	
#										
Hose Fitting			inch	inch	mm	inch	mm	mm	mm	
1C658-10-4 (+)	+	M18x1,5	1/4	2.31	59	1.13	29	19	24	PUF 505
1C658-12-5 (+)	+	M20x1,5	5/16	2.45	62	1.19	30	24	24	PUF 505
1C658-14-6 (+)	+	M22x1,5	3/8	2.70	69	1.24	31	27	27	PUF 505
1C658-16-8 (+)	+	M24x1,5	1/2	2.87	73	1.26	32	27	30	PUF 506
1C658-20-12	+	M30x2	3/4	3.22	82	1.30	34	36	36	PUF 507
1C658-25-12 (+)	+	M36x2	3/4	3.23	82	1.38	35	41	42	PUF 508
1C658-30-16 (+)	+	M42x2	1	3.86	98	1.34	34	41	46	PUF 509

1D058 Male Stud DIN 20078 Light Series

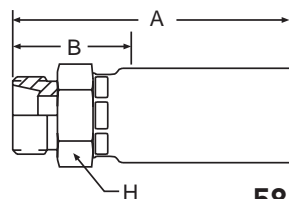

58 Series Permanent

Steel Part Number	C	Thread Size	Tube O.D.	Hose I.D.	A		Cutoff Allow. B		H Hex	Pusher Number
					inch	mm	inch	mm	mm	
#										
Hose Fitting				inch	inch	mm	inch	mm	mm	
1D058-8-4 (+)	+	M14x1,5	8	1/4	2.17	55	0.98	25	19	PUM 503
1D058-10-5 (+)	+	M16x1,5	10	5/16	2.28	58	1.02	26	19	PUM 503
1D058-10-6 (+)	+	M16x1,5	10	3/8	2.52	64	1.02	26	22	PUM 503
1D058-12-6 (+)	+	M18x1,5	12	3/8	2.52	64	1.06	27	22	PUM 504
1D058-15-8 (+)	+	M22x1,5	15	1/2	2.80	71	1.18	30	27	PUM 507
1D058-18-12 (+)	+	M26x1,5	18	3/4	3.30	77	1.18	30	32	PUM 509
1D058-22-12 (+)	+	M30x2	22	3/4	3.11	79	1.22	31	36	PUM 510
1D058-28-16 (+)	+	36x2	28	1	3.54	90	1.22	31	41	PUM 511

(+) Non Standard. See page ii for information on non-standard products.

1D258 Male Stud DIN 20078 Heavy Series

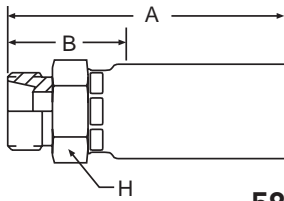

58 Series Permanent

Steel Part Number	C	Thread Size	Tube O.D.	Hose I.D.	A		Cutoff Allow. B		H Hex	Pusher Number
					inch	mm	inch	mm		
#										
Hose Fitting				inch	inch	mm	inch	mm	mm	
1D258-10-4 (+)	+	M18x1,5	10	1/4	2.28	58	1.10	28	22	PUM 504
1D258-12-5 (+)	+	M20x1,5	12	5/16	2.44	62	1.18	30	24	PUM 505
1D258-14-6 (+)	+	M22x1,5	14	3/8	2.72	69	1.26	32	27	PUM 507
1D258-16-8 (+)	+	M24x1,5	16	1/2	2.87	73	1.26	32	27	PUM 507
1D258-20-12	+	M30x2	20	3/4	3.19	81	1.30	33	36	PUM 510
1D258-25-12 (+)	+	M36x2	25	3/4	3.27	83	1.38	35	41	PUM 511
1D258-30-16	+	M42x2	30	1	3.90	99	1.38	35	46	PUM 512

11D58 Metric Standpipe Light Series

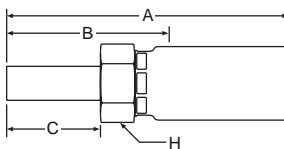

58 Series Permanent

Steel Part Number	C	Tube O.D.	Hose I.D.	A		Cutoff Allow. B		C Hex	H Hex	Pusher Number
				inch	mm	inch	mm	mm	mm	
#										
Hose Fitting			inch	inch	mm	inch	mm	mm	mm	
11D58-8-4 (+)	+	8	1/4	2.60	66	1.42	36	22	17	PUM 502
11D58-10-5 (+)	+	10	5/16	2.76	70	1.46	37	23	17	PUM 502
11D58-10-6 (+)	+	10	3/8	2.95	75	1.46	37	23	19	PUM 502
11D58-12-6 (+)		12	3/8	2.95	75	1.50	38	23	19	PUM 503
11D58-15-8	+	15	1/2	3.23	82	1.61	41	25	22	PUM 504
11D58-18-12	+	18	3/4	3.23	82	1.54	39	25	30	PUM 508
11D58-22-12	+	22	3/4	3.66	93	1.77	45	28	30	PUM 508
11D58-28-16 (+)	+	28	1	4.17	106	1.85	47	30	41	PUM 511

(+) Non Standard. See page ii for information on non-standard products.

19258 BSP Swivel

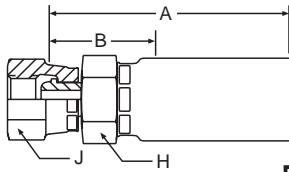

58 Series Permanent

Steel Part Number	C	BSP Thread Size	Hose I.D.	A		Cutoff Allow. B		H Hex	J Hex	Pusher Number
				inch	mm	inch	mm	mm	mm	
#										
Hose Fitting			inch	inch	mm	inch	mm	mm	mm	
19258-4-4 (+)	+	PF 1/4-19	1/4	2.24	57	1.02	26	17	19	PUF 013
19258-6-5 (+)	+	PF 3/8-19	5/16	2.36	60	1.06	27	19	22	PUF 305
19258-6-6 (+)	+	PF 3/8-19	3/8	2.56	65	1.06	27	19	22	PUF 306
19258-8-8 (+)	+	PF 1/2-14	1/2	2.91	74	1.22	31	24	27	PUF 308
19258-10-8 (+)	+	PF 5/8-14	1/2	3.27	83	1.34	34	27	30	PUF 008
19258-12-12	+	PF 3/4-14	3/4	3.27	83	1.38	35	32	36	PUF 008
19258-16-16 (+)	+	PF 1-11	1	3.86	98	1.54	39	36	41	PUF 508

1B158 BSP Swivel 45° Elbow

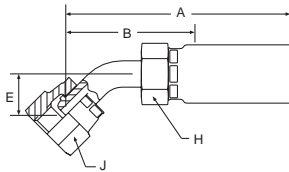

58 Series Permanent

Steel Part Number	C	BSP Thread Size	Hose I.D.	A		Cutoff Allow. B		E		H Hex	J Hex	Pusher Number
				inch	mm	inch	mm	inch	mm	mm	mm	
#												
Hose Fitting			inch	inch	mm	inch	mm	inch	mm	mm	mm	
1B158-4-4 (+)	+	PF 1/4-19	1/4	2.76	70	1.54	39	0.55	14	17	19	PUT 002
1B158-6-5 (+)	+	PF 3/8-19	5/16	2.91	74	1.61	41	0.63	16	17	22	PUT 002
1B158-6-6 (+)	+	PF 3/8-19	3/8	3.11	79	1.61	41	0.63	16	19	22	PUT 003
1B158-8-8 (+)	+	PF 1/2-14	1/2	3.54	90	1.85	47	0.67	17	22	27	PUT 008
1B158-10-8 (+)	+	PF 5/8-14	1/2	3.58	91	1.89	48	0.67	17	22	30	PUT 008
1B158-12-12 (+)	+	PF 3/4-14	3/4	4.09	104	2.20	56	0.87	22	30	32	PUT 005
1B158-16-16	+	PF 1-11	1	4.80	122	2.48	63	0.98	25	38	41	PUT 007

(+) Non Standard. See page ii for information on non-standard products.

PTFE Hose & Fittings

Thermoplastic Tubing

Coiled Air Hose, Fittings & Accessories

Truck (Fleet) Products

Tooling & Equipment

Hose Accessories

Technical & Design Information

Approvals & Guides

Alphanumeric Index

1B258 BSP Swivel 90° Elbow

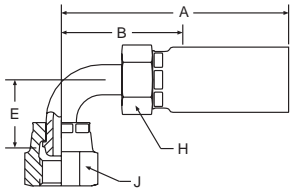

58 Series Permanent

Steel Part Number	C	BSP Thread Size	Hose I.D.	A		Cutoff Allow. B		E		H Hex	J Hex	Pusher Number
				inch	mm	inch	mm	inch	mm	mm	mm	
#												
Hose Fitting			inch	inch	mm	inch	mm	inch	mm	mm	mm	
1B258-4-4 (+)	+	PF 1/4-19	1/4	2.48	63	1.23	32	1.14	29	17	19	PUT 002
1B258-6-5 (+)	+	PF 3/8-19	5/16	2.72	69	1.42	36	1.34	34	17	22	PUT 002
1B258-6-6	+	PF 3/8-19	3/8	2.95	75	1.46	37	1.50	38	19	22	PUT 003
1B258-8-8	+	PF 1/2-14	1/2	3.27	83	1.57	40	1.57	40	22	27	PUT 008
1B258-10-8 (+)	+	PF 5/8-14	1/2	3.27	83	1.57	40	1.54	39	22	30	PUT 005
1B258-12-12 (+)	+	PF 3/4-14	3/4	3.94	100	2.05	52	2.20	56	30	32	PUT 005
1B258-16-16	+	PF 1-11	1	4.69	119	2.36	60	2.28	58	38	41	PUT 007

1D958 Male BSP

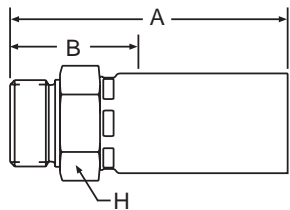

58 Series Permanent

Steel Part Number	C	BSP Thread Size	Hose I.D.	A		Cutoff Allow. B		H Hex	Pusher Number
				inch	mm	inch	mm	mm	
#									
Hose Fitting			inch	inch	mm	inch	mm	mm	
1D958-4-4 (+)	+	PF 1/4-19	1/4	2.24	57	1.02	26	19	PUM 503
1D958-6-5 (+)	+	PF 3/8-19	5/16	2.36	60	1.06	27	22	PUM 504
1D958-6-6 (+)	+	PF 3/8-19	3/8	2.52	64	1.06	27	22	PUM 504
1D958-8-8 (+)	+	PF 1/2-14	1/2	2.87	73	1.22	31	27	PUM 506
1D958-12-12 (+)	+	PF 3/4-14	3/4	3.19	81	1.34	34	32	PUM 509
1D958-16-16	+	PF 1-11	1	3.74	95	1.38	35	41	PUM 511

(+) Non Standard. See page ii for information on non-standard products.

13D58 Metric Standpipe Heavy Series

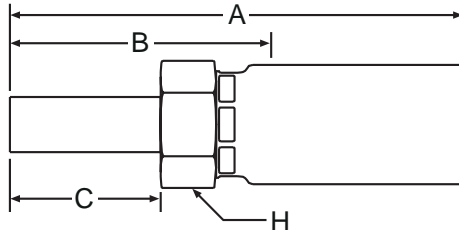

58 Series Permanent

Steel Part Number	C	Tube O.D.	Hose I.D.	A		Cutoff Allow. B		C		H Hex	Pusher Number
				inch	mm	inch	mm	inch	mm		
#											
Hose Fitting			inch	inch	mm	inch	mm	inch	mm	mm	
13D58-10-4 (+)	+	10	1/4	2.72	69	1.54	39	0.94	24	17	PUM 502
13D58-12-5 (+)	+	12	5/16	2.91	74	1.61	41	1.02	26	17	PUM 502
13D58-12-6 (+)	+	12	3/8	3.07	78	1.57	40	1.02	26	19	PUM 503
13D58-14-6 (+)	+	14	3/8	3.19	81	1.73	44	1.02	26	19	PUM 503
13D58-16-8 (+)	+	16	1/2	3.43	87	1.81	46	1.18	30	22	PUM 504
13D58-20-12 (+)	+	20	3/4	3.50	89	1.61	41	1.42	36	30	PUM 508
13D58-25-12 (+)	+	25	3/4	3.58	91	1.69	43	1.57	40	30	PUM 508
13D58-30-16 (+)	+	30	1	4.02	102	2.05	52	1.73	44	41	PUM 511

(+) Non Standard. See page ii for information on non-standard products.

PTFE Hose & Fittings

Thermoplastic Tubing

Coiled Air Hose, Fittings & Accessories

Truck (Fleet) Products

Tooling & Equipment

Hose Accessories

Technical & Design Information

Approvals & Guides

Alphanumeric Index

11192 Ferrul-Fix

Nut and Sleeve Included

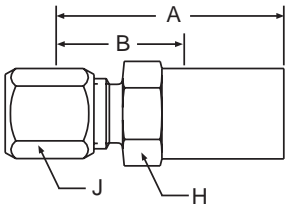

92 Series Permanent

Steel Part Number	B	C	Thread Size	Tube O. D.	Hose I.D.	A		Cutoff Allow. B		H Hex	J Hex	Pusher Number
						inch	mm	inch	mm			
#												
Hose Fitting				inch	inch	inch	mm	inch	mm	inch	inch	
11192-3-3 (+)			3/8-24	3/16	3/16	1.37	35	15/16	24	5/8	7/16	PUM 019

"Ferrul-Fix" affords salvaging of bent tube section of combination tube-hose assemblies and quick, easy repair on the job.

NOTE: Nut Part Number is 111-size
Sleeve Part Number is 110-size

12892 SAE Male Inverted Swivel Straight

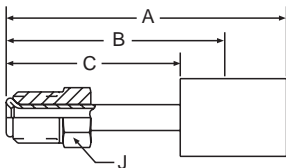

92 Series Permanent

Steel Part Number	B	C	Thread Size	Tube O. D.	Hose I.D.	A		Cutoff Allow. B		C		J Hex	Pusher Number
						inch	mm	inch	mm	inch	mm		
#													
Hose Fitting				inch	inch	inch	mm	inch	mm	inch	mm		
12892-3-3 (+)			3/8-24	3/16	3/16	2.01	51	1-1/2	38	1.25	32	7/16	PUT 014

(+) Non Standard. See page ii for information on non-standard products.

16792 SAE Male Inverted Swivel 45° Elbow

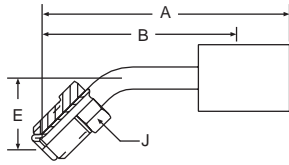

92 Series Permanent

Steel Part Number	B	C	Thread Size	Tube O. D.	Hose I.D.	A		Cutoff Allow. B		J Hex	E		Pusher Number
						inch	mm	inch	mm		inch	mm	
#													
Hose Fitting				inch	inch	inch	mm	inch	mm	inch	inch	mm	
16792-3-3 (+)			3/8-24	3/16	3/16	2.36	60	1-15/16	50	3/8	0.62	16	PUT 014

16992 SAE Male Inverted Swivel 90° Elbow

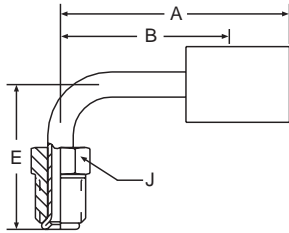

92 Series Permanent

Steel Part Number	B	C	Thread Size	Tube O. D.	Hose I.D.	A		Cutoff Allow. B		J Hex	E		Pusher Number
						inch	mm	inch	mm		inch	mm	
#													
Hose Fitting				inch	inch	inch	mm	inch	mm	inch	inch	mm	
16992-3-3 (+)			3/8-24	3/16	3/16	1.45	37	1	25	3/8	1.25	32	PUT 014

(+) Non Standard. See page ii for information on non-standard products.

PTFE Hose & Fittings

Thermoplastic Tubing

Coiled Air Hose, Fittings & Accessories

Truck (Fleet) Products

Tooling & Equipment

Hose Accessories

Technical & Design Information

Approvals & Guides

Alphanumeric Index

201BA Male NPTF Rigid Straight

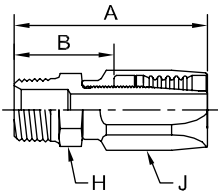

Steel Part Number	B	C	NPTF Thread Size	Hose I.D.	A		Cutoff Allow. B		H Hex	J Hex
					inch	mm	inch	mm		
#										
Hose Fitting				inch	inch	mm	inch	mm	inch	inch
201BA-2-4	+	+	1/8-27	1/4	2.25	57	0.97	25	5/8	3/4
201BA-4-4	+	+	1/4-18	1/4	2.44	62	1.16	30	5/8	3/4
201BA-6-4	+	+	3/8-18	1/4	2.44	62	1.16	30	3/4	3/4
201BA-4-6	+	+	1/4-18	3/8	2.63	67	1.22	31	3/4	7/8
201BA-6-6	+	+	3/8-18	3/8	2.63	67	1.22	31	3/4	7/8
201BA-8-6	+	+	1/2-14	3/8	2.81	71	1.41	36	7/8	7/8
201BA-8-8	+	+	1/2-14	1/2	3.16	80	1.56	40	7/8	1-1/16
201BA-12-12	+	+	3/4-14	3/4	3.19	81	1.53	39	1-1/8	1-5/16
201BA-16-16	+	+	1-11-1/2	1	3.69	94	2.06	52	1-1/2	1-5/8

203BA Male JIC 37° Rigid Straight

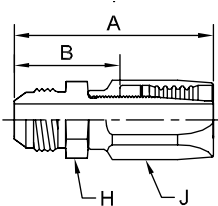

Steel Part Number	B	C	Thread Size	Hose I.D.	A		Cutoff Allow. B		H Hex	J Hex
					inch	mm	inch	mm		
#										
Hose Fitting				inch	inch	mm	inch	mm	inch	inch
203BA-5-4	+	+	1/2-20	1/4	2.42	62	1.13	29	5/8	3/4
203BA-6-6	+	+	9/16-18	3/8	2.63	67	1.22	31	3/4	7/8
203BA-8-6	+	+	3/4-16	3/8	2.72	69	1.31	33	3/4	7/8
203BA-10-8	+	+	7/8-14	1/2	3.16	80	1.56	40	1	1-1/16
203BA-12-12	+	+	1 1/16-12	3/4	3.30	84	1.66	42	1 1/8	1-5/16

206BA Female JIC 37° Swivel Straight

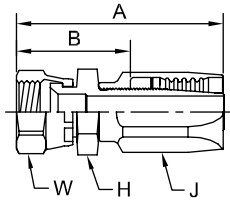

Steel Part Number	B	C	Thread Size	Hose I.D.	A		Cutoff Allow. B		H Hex	J Hex	W Hex
					inch	mm	inch	mm			
#											
Hose Fitting				inch	inch	mm	inch	mm	inch	inch	inch
206BA-4-4	+	+	7/6-20	1/4	2.52	64	1.22	31	5/8	3/4	9/16
206BA-5-4	+	+	1/2-20	1/4	2.56	65	1.34	34	5/8	3/4	5/8
206BA-6-4	+	+	9/16-18	1/4	2.58	66	1.28	33	11/16	3/4	11/16
206BA-5-6	+	+	1/2-20	3/8	2.75	70	1.34	34	3/4	7/8	5/8
206BA-6-6	+	+	9/16-18	3/8	2.77	70	1.34	34	3/4	7/8	11/16
206BA-8-6	+	+	3/4-16	3/8	2.81	71	1.41	36	7/8	7/8	7/8
206BA-8-8	+	+	3/4-16	1/2	3.16	80	1.56	40	1	1-1/16	7/8
206BA-10-8	+	+	7/8-14	1/2	3.24	82	1.63	41	1	1-1/16	1
206BA-12-12	+	+	1 1/16-12	3/4	3.33	85	1.69	43	1 1/4	1-5/16	1 1/4
206BA-16-16	+	+	1 5/16-12	1	3.72	95	2.10	53	1 1/2	1-5/8	1 1/2

208BA Female SAE 45° Swivel Straight

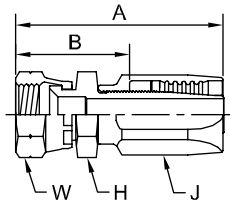

Steel Part Number	B	C	Thread Size	Hose I.D.	A		Cutoff Allow. B		H Hex	J Hex	W Hex
					inch	mm	inch	mm			
#											
Hose Fitting				inch	inch	mm	inch	mm	inch	inch	inch
208BA-6-6 (+)	+	+	5/8-18	3/8	2.83	72	1.41	36	3/4	7/8	3/4

237BA Female JIC 37° Swivel 45° Elbow Short Drop

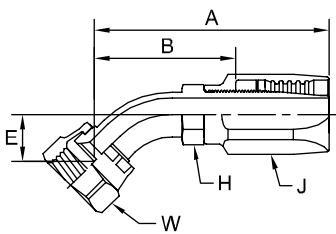

Steel Part Number	B	C	Thread Size	Tube O.D.	Hose I.D.	A		Cutoff Allow. B		E		H Hex	J Hex	W Hex
						inch	mm	inch	mm	inch	mm			
#														
Hose Fitting				inch	inch	inch	mm	inch	mm	inch	mm	inch	inch	inch
237BA-8-6 (+)	+	+	3/4-16	1/2	3/8	3.09	79	1.69	43	0.55	14	3/4	7/8	7/8
237BA-10-8 (+)	+	+	7/8-14	5/8	1/2	3.53	90	1.94	49	0.63	16	7/8	1	1-1/16
237BA-12-12 (+)	+	+	1 1/16-12	1	3/4	3.75	95	2.13	54	0.77	20	1 1/8	1 1/4	1-5/16

239BA Female JIC 37° Swivel 90° Elbow Short Drop

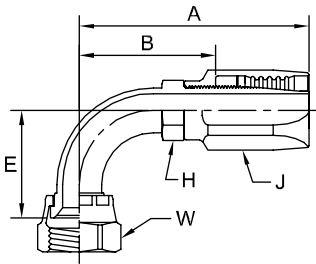

Steel Part Number	B	C	Thread Size	Tube O.D.	Hose I.D.	A		Cutoff Allow. B		E		H Hex	J Hex	W Hex
						inch	mm	inch	mm	inch	mm	inch	inch	inch
#														
Hose Fitting				inch	inch	inch	mm	inch	mm	inch	mm	inch	inch	inch
239BA-6-6	+	+	9/16-18	3/8	3/8	2.70	69	1.31	33	0.86	22	3/4	11/16	0.69
239BA-16-16 (+)	+	+	15/16-12	1	1	4.39	112	2.75	70	2.14	54	1 1/2	1 1/2	1.50

241BA Female JIC 37° Swivel 90° Elbow Long Drop

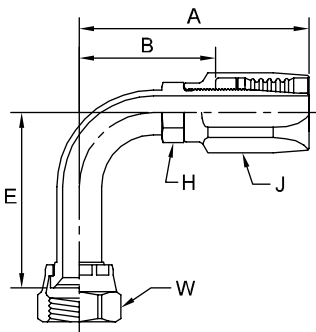

Steel Part Number	B	C	Thread Size	Tube O.D.	Hose I.D.	A		Cutoff Allow. B		E		H Hex	J Hex	W Hex
						inch	mm	inch	mm	inch	mm	inch	inch	inch
#														
Hose Fitting				inch	inch	inch	mm	inch	mm	inch	mm	inch	inch	inch
241BA-12-12 (+)	+	+	1-1/16 - 12	3/4	3/4	3.94	100	2.31	59	3.73	95	1-1/8	1-1/4	1-5/16

PTFE Hose & Fittings

Thermoplastic Tubing

Coiled Air Hose, Fittings & Accessories

Truck (Fleet) Products

Tooling & Equipment

Hose Accessories

Technical & Design Information

Approvals & Guides

Alphanumeric Index

201BG Male NPTF Rigid Straight

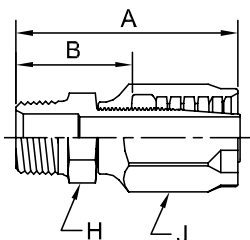

Steel Part Number	B	C	NPTF Thread Size	Hose I.D.	A		Cutoff Allow. B		H Hex	J Hex
					inch	mm	inch	mm		
#										
Hose Fitting				inch	inch	mm	inch	mm	inch	inch
201BG-2-3		+	1/8-27	3/16	1.78	45	0.81	21	1/2	5/8
201BG-4-3	+	+	1/4-18	3/16	1.97	50	1.00	25	5/8	5/8
201BG-4-4	+	+	1/4-18	1/4	2.06	52	1.06	27	5/8	11/16
201BG-4-5	+	+	1/4-18	5/16	2.38	61	1.25	32	5/8	3/4
201BG-6-6	+		3/8-18	3/8	2.63	67	1.31	33	7/8	7/8
201BG-8-8		+	1/2-14	1/2	3.13	80	1.63	41	1	1-1/16

203BG Male JIC 37° Rigid Straight

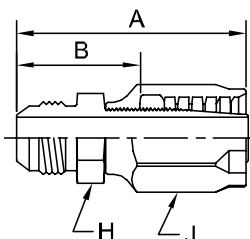

Steel Part Number	B	C	Thread Size	Hose I.D.	A		Cutoff Allow. B		H Hex	J Hex
					inch	mm	inch	mm		
#										
Hose Fitting				inch	inch	mm	inch	mm	inch	inch
203BG-4-3	+	+	7/16-20	3/16	1.96	50	1.00	25	1/2	5/8
203BG-4-4	+	+	7/16-20	1/4	2.05	52	1.06	27	5/8	11/16
203BG-5-4	+	+	1/2-20	1/4	2.05	52	1.06	27	5/8	11/16
203BG-6-5	+	+	9/16-18	5/16	2.37	60	1.25	32	5/8	3/4
203BG-6-6	+	+	9/16-18	3/8	2.62	67	1.31	33	7/8	7/8
203BG-8-6		+	3/4-16	3/8	2.72	69	1.41	36	7/8	7/8
203BG-8-8		+	3/4-16	1/2	3.03	77	1.53	39	1	1-1/16
203BG-10-8		+	7/8-14	1/2	3.13	80	1.63	41	1	1-1/16

DISCONTINUED

PTFE Hose & Fittings

Thermoplastic Tubing

Coiled Air Hose, Fittings & Accessories

Truck (Fleet) Products

Tooling & Equipment

Hose Accessories

Technical & Design Information

Approvals & Guides

Alphanumeric Index

206BG Female JIC 37° Swivel Straight

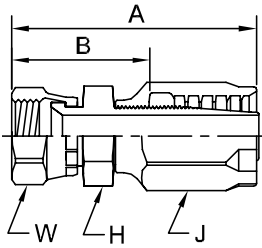

Steel Part Number	B	C	Thread Size	Hose I.D.	A		Cutoff Allow. B		H Hex	J Hex	W Hex
					inch	mm	inch	mm	inch	inch	inch
#											
Hose Fitting				inch	inch	mm	inch	mm	inch	inch	inch
206BG-4-3	+	+	7/16-20	3/16	2.05	52	20.8	27	9/16	5/8	9/16
206BG-4-4	+	+	7/16-20	1/4	2.14	54	29	29	5/8	11/16	9/16
206BG-5-4	+	+	1/2-20	1/4	2.25	57	30	30	5/8	11/16	5/8
206BG-6-5	+	+	9/16-18	5/16	2.52	64	35	35	11/16	3/4	11/16
206BG-6-6	+	+	9/16-18	3/8	2.77	70	37	37	7/8	7/8	11/16
206BG-8-6		+	3/4-16	3/8	2.81	71	38	38	7/8	7/8	7/8
206BG-8-8		+	3/4-16	1/2	3.06	78	40	40	1	1-1/16	1

213BG Male NPTF Pipe Swivel Under Pressure - Straight

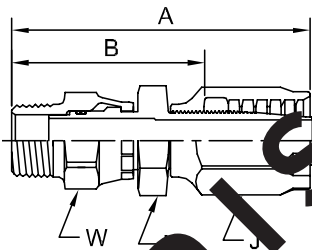

Steel Part Number	B	C	NPTF Thread Size	Hose I.D.	A		Cutoff Allow. B		H Hex	J Hex	W Hex
					inch	mm	inch	mm	inch	inch	inch
#											
Hose Fitting				inch	inch	mm	inch	mm	inch	inch	inch
213BG-2-3	+	+	1/8-27	3/16	2.44	62	1.47	37	5/8	5/8	5/8
213BG-4-3	+	+	1/4-18	3/16	2.50	64	1.53	39	5/8	5/8	5/8
213BG-4-4	+	+	1/4-18	1/4	2.59	66	1.59	40	5/8	11/16	5/8
213BG-4-5	+	+	1/4-18	5/16	3.03	77	1.91	49	11/16	3/4	11/16
213BG-6-6	+	+	3/8-18	3/8	3.28	83	1.97	50	7/8	7/8	7/8
213BG-8-8		+	1/2-14	1/2	3.78	96	2.28	58	1	1-1/16	1

SQ Mender

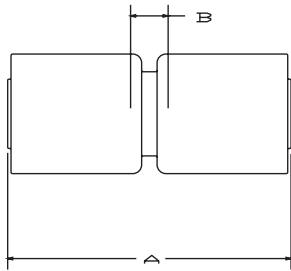

Part Number	Steel Part Number	Hose I.D.	A		Cutoff Allow. B		Swage Die
			inch	mm	inch	mm	
#	#						
Hose	Fitting	inch	inch	mm	inch	mm	
S612	1HUSQ-12-12	3/4	3.70	94	0.53	14	SQ-101-12S6/S9
S616	1HUSQ-16-16	1	3.99	101	0.53	14	SQ-101-16S6
S620	1HUSQ-20-20	1 1/4	4.53	115	0.53	14	SQ-101-20S6
S912	1HUSQ-12-12	3/4	3.70	94	0.53	14	SQ-101-12S9
S916	1HUSQ-16-16	1	3.99	101	0.53	14	SQ-101-16S9

101SQ

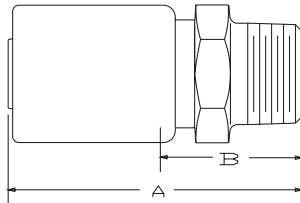

Part Number	Steel Part Number	Hose I.D.	A		Cutoff Allow. B		Swage Die	Swage Pusher
			inch	mm	inch	mm		
#	#							
Hose	Fitting	inch	inch	mm	inch	mm		
S612	101SQ-12-12	3/4	3.70	94	0.53	13	SQ-101-12S6/S9	SQ-101-12P
S616	101SQ-16-16	1	3.99	101	0.53	13	SQ-101-16S6	SQ-101-16P
S620	101SQ-20-20	1 1/4	4.53	115	0.53	13	SQ-101-20S6	SQ-101-20P
S912	101SQ-12-12	3/4	3.70	94	0.53	13	SQ-101-12S9	SQ-101-12P
S916	101SQ-16-16	1	3.99	101	0.53	13	SQ-101-16S9	SQ-101-16P

PTFE Hose & Fittings

Thermoplastic Tubing

Coiled Air Hose, Fittings & Accessories

Truck (Fleet) Products

Tooling & Equipment

Hose Accessories

Technical & Design Information

Approvals & Guides











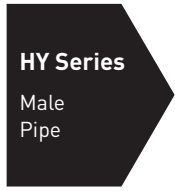
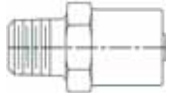
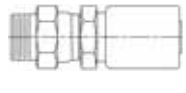
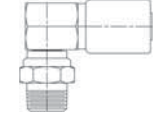
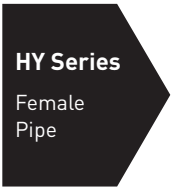
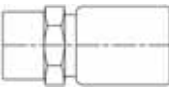
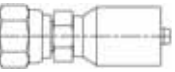

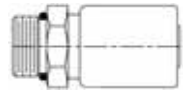
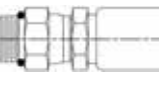

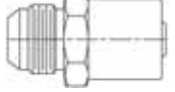
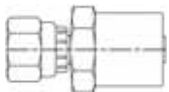
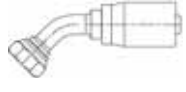



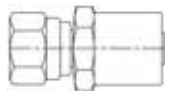
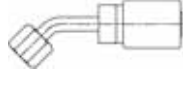
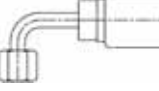

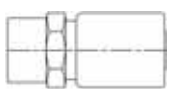

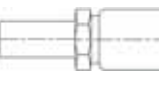

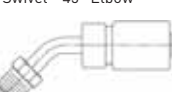
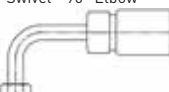
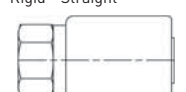
Alphanumeric Index

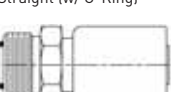
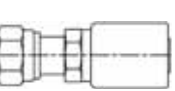
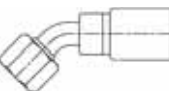
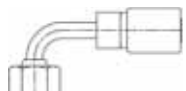

A large section of the page consisting of numerous horizontal lines, intended for taking notes.

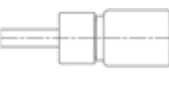
Alphanumeric Index	Approvals & Guides	Technical & Design Information	Hose Accessories	Tooling & Equipment	Truck (Fleet) Products	Coiled Air Hose, Fittings & Accessories	Thermoplastic Tubing	PTFE Hose & Fittings	Hydraulic & Pneumatic Hose & Fit.
--------------------	--------------------	--------------------------------	------------------	---------------------	------------------------	---	----------------------	----------------------	-----------------------------------

HY fittings have been added to this catalog for reference only purposes.

HY Series Hose Fittings

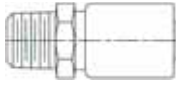
PTFE Hose & Fittings	 <p>HY Series Male Pipe</p>	<p>101 Male NPTF Pipe Rigid - Straight</p>  <p>HY-MP pg. 114</p>	<p>113 Male NPTF Pipe - Swivel - Straight</p>  <p>HY-MS & HY-SP pg. 114</p>	<p>111L Male NPTF Pipe - Swivel - 90° Elbow</p>  <p>HY-SP90 pg. 115</p>	 <p>HY Series Female Pipe</p>	<p>102 Female NPTF Pipe Rigid - Straight</p>  <p>HY-FF pg. 115</p>
	Thermoplastic Tubing	<p>107 Female NPSM Pipe - Swivel - Straight (60° Cone)</p>  <p>HY-RV pg. 115</p>	 <p>HY Series Straight Thread O-Ring</p>	<p>105 Male SAE Straight Thread with O-Ring - Rigid - Straight</p>  <p>HY-RA pg. 116</p>	<p>106 Male SAE Straight Thread with O-Ring - Swivel - Straight</p>  <p>HY-RC pg. 116</p>	<p>10L Male SAE Straight Thread with O-Ring - Swivel - 90° Elbow</p>  <p>HY-RC90 pg. 117</p>
Coiled Air Hose, Fittings & Accessories		<p>103 Male JIC 37° Rigid - Straight</p>  <p>HY-MJ pg. 117</p>	<p>106 Female JIC 37° Swivel - Straight</p>  <p>HY-FJ pg. 118</p>	<p>137 Female JIC 37° Swivel - 45° Elbow - Short Drop</p>  <p>HY-FJ45T pg. 119</p>	<p>139 Female JIC 37° Swivel - 90° Elbow - Short Drop</p>  <p>HY-FJ90T pg. 119</p>	<p>141 Female JIC 37° Swivel - 90° Elbow - Long Drop</p>  <p>HY-FJ90TL pg. 120</p>
	Truck (Fleet) Products	 <p>HY Series SAE 45°</p>	<p>108 Female SAE 45° Swivel - Straight</p>  <p>HY-FA pg. 121</p>	<p>177 Female SAE 45° Swivel - 45° Elbow</p>  <p>HY-FA45T pg. 121</p>	<p>179 Female SAE 45° Swivel - 90° Elbow</p>  <p>HY-FA90T pg. 121</p>	 <p>HY Series Flareless</p>
Tooling & Equipment		 <p>HY Series Grease Connection</p>	<p>16J Female Grease Connection - Special PTF Taper Thread - Rigid - Straight - 1/2x27</p>  <p>HY-NV pg. 122</p>	 <p>HY Series Standpipe</p>	<p>134 Male Standpipe Rigid - Straight</p>  <p>HY-RL pg. 122</p>	 <p>HY Series Inverted Flare</p>
	Hose Accessories	<p>167 Male Inverted SAE 45° - Swivel - 45° Elbow</p>  <p>HY-MF45T pg. 123</p>	<p>169 Male Inverted SAE 45° - Swivel - 90° Elbow</p>  <p>HY-MF90T pg. 123</p>	<p>129 Female Inverted SAE 45° - Rigid - Straight</p>  <p>HY-NG pg. 124</p>	 <p>HY Series Seal-Lok™</p>	<p>1J0 Male Seal-Lok™ Rigid - Straight (w/ O-Ring)</p>  <p>HY-OM pg. 124</p>
Technical & Design Information		<p>1JS Female Seal-Lok™ Swivel - Straight - Long</p>  <p>HY-OFT pg. 125</p>	<p>1J7 Female Seal-Lok™ Swivel - 45° Elbow</p>  <p>HY-OF45T pg. 125</p>	<p>1J9 Female Seal-Lok™ Swivel - 90° Elbow - Short Drop</p>  <p>HY-OF90T pg. 126</p>	<p>1J1 Female Seal-Lok™ Swivel - 90° Elbow - Long Drop</p>  <p>HY-OF90TL pg. 126</p>	 <p>HY Series DIN "L" Series</p>
	Approvals & Guides	 <p>HY Series DIN "S" Series</p>	<p>13D Male Standpipe Metric S - Rigid - Straight</p>  <p>HY-RZT pg. 127</p>	 <p>HY Series BSP</p>	<p>1D9 Male BSP Parallel Pipe - Rigid - Straight (60° Cone)</p>  <p>HY-BP pg. 127</p>	<p>16U Female BSP Parallel Pipe - Swivel - Straight (60° Flare)</p>  <p>HY-BPF pg. 128</p>
Alphanumeric Index						

HY Series Hose Fittings					
HY Series BSP 60° Cone	1UT Male BSP Taper Pipe Rigid - Straight  HY-BT pg. 128	HY Series BSP 30° Flare	1XU Female Metric Swivel - Straight (30° Flare)  HY-KMF pg. 128		

Note: HY fittings shown in this catalog are for reference purposes only. HY, 43, and 82 series hose fittings used on some Parflex® products are the sole property of the Parker Hannifin Hose Products Division. The Hose Products Division is ultimately responsible for all engineering drawings and running manufacturing changes. The Monoblock™ construction processes, specific to the HY series, may result in dimensional changes. Please consult HPD should you have any questions when ordering these products or before consulting Crimp Source.

101HY (HY-MP) Male NPTF Pipe Rigid - Straight

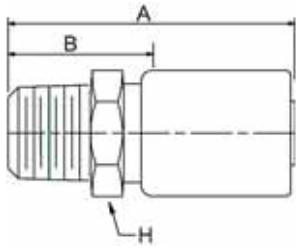

Note: "C303" - Stainless Steel Fitting

Steel Part Number	Thread Size		Hose I.D.		A		H Hex	Cutoff Allow. B	
	inch		inch		inch	mm	inch	inch	mm
#									
Hose Fitting	inch		inch		inch	mm	inch	inch	mm
101HY-2-4	1/8x27	-2	1/4	-4	2.34	59	5/8	1.00	25
101HY-4-4	1/4x18	-4	1/4	-4	2.53	64	9/16	1.19	30
101HY-4-4C303	1/4x18	-4	1/4	-4	2.53	64	9/16	1.19	30
101HY-4-6	1/4x18	-4	3/8	-6	2.55	65	11/16	1.19	30
101HY-6-4	3/8x18	-6	1/4	-4	2.53	64	3/4	1.19	30
101HY-6-6	3/8x18	-6	3/8	-6	2.55	65	3/4	1.19	30
101HY-6-6C303	3/8x18	-6	3/8	-6	2.55	65	3/4	1.19	30
101HY-8-4	1/2x14	-8	1/4	-4	2.72	69	7/8	1.38	35
101HY-8-6	1/2x14	-8	3/8	-6	2.73	69	7/8	1.38	35
101HY-8-8	1/2x14	-8	1/2	-8	2.91	74	7/8	1.56	40
101HY-8-8C303	1/2x14	-8	1/2	-8	2.91	74	7/8	1.56	40
101HY-8-10	1/2x14	-8	5/8	-10	2.94	75	1-1/8	1.59	40
101HY-8-12	1/2x14	-8	3/4	-12	3.08	78	1-1/4	1.50	38
101HY-12-8	3/4x14	-12	1/2	-8	2.91	74	1-1/16	1.56	40
101HY-12-10	3/4x14	-12	5/8	-10	2.98	76	1-1/8	1.59	40
101HY-12-12	3/4x14	-12	3/4	-12	3.08	78	1-1/4	1.50	38
101HY-12-12C303	3/4x14	-12	3/4	-12	3.08	78	1-1/4	1.50	38
101HY-12-16	3/4x14	-12	1	-16	3.23	82	1-3/8	1.63	41
101HY-16-12	1x11-1/2	-16	3/4	-12	3.27	83	1-3/8	1.69	43
101HY-16-16	1x11-1/2	-16	1	-16	3.42	87	1-3/8	1.81	46
101HY-16-16C303	1x11-1/2	-16	1	-16	3.42	87	1-3/8	1.81	46

113HY (HY-MS and HY-SP) Male NPTF Pipe - Swivel - Straight

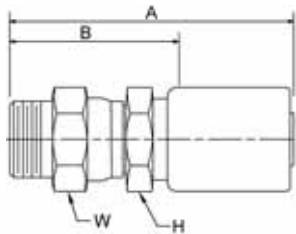

Steel Part Number	Thread Size		Hose I.D.		A		H Hex	W Hex	Cutoff Allow. B	
	inch		inch		inch	mm	inch	inch	inch	mm
#										
Hose Fitting	inch		inch		inch	mm	inch	inch	inch	mm
113HY-2-4	1/8x27	-2	1/4	-4	2.97	75	9/16	5/8	1.63	41
113HY-4-4	1/4x18	-4	1/4	-4	3.06	78	9/16	5/8	1.72	44
113HY-4-6	1/4x18	-4	3/8	-6	3.17	81	11/16	11/16	1.81	46
113HY-6-4	3/8x18	-6	1/4	-4	3.13	80	5/8	11/16	1.78	45
113HY-6-6	3/8x18	-6	3/8	-6	3.11	79	11/16	11/16	1.75	44
113HY-6-8	3/8x18	-6	1/2	-8	3.31	84	7/8	7/8	1.97	50
113HY-8-6	1/2x14	-8	3/8	-6	3.38	86	7/8	7/8	2.03	52
113HY-8-8	1/2x14	-8	1/2	-8	3.50	89	7/8	7/8	2.16	55
113HY-12-12	3/4x14	-12	3/4	-12	3.95	100	1-1/4	1-1/4	2.38	60
113HY-16-16	1x11-1/2	-16	1	-16	4.23	107	1-1/2	1-1/2	2.63	67

11LHY (HY-SP90) Male NPTF Pipe Swivel - 90° Elbow

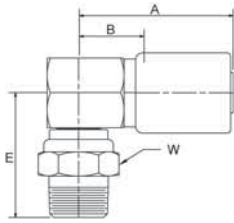

Steel Part Number	Thread Size		Hose I.D.		A		E		W Hex		B	
	inch		inch		inch	mm	inch	mm	inch	inch	mm	
#												
11LHY-4-4	1/4x18	-4	1/4	-4	2.31	59	1.69	43	11/16	0.97	25	
11LHY-4-6	1/4x18	-4	3/8	-6	2.33	59	1.69	43	11/16	0.97	25	
11LHY-6-6	3/8x8	-6	3/8	-6	2.33	59	1.63	41	11/16	0.97	25	
11LHY-8-6	1/2x14	-8	3/8	-6	2.73	69	1.88	48	7/8	0.97	25	
11LHY-8-8	1/2x14	-8	1/2	-8	3.00	76	1.93	49	7/8	1.09	28	

102HY (HY-FF) Female NPTF Pipe Rigid - Straight

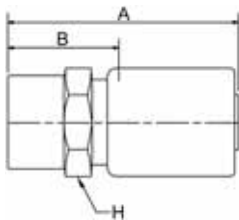

Steel Part Number	Thread Size		Hose I.D.		A		H Hex	Cutoff Allow. B	
	inch		inch		inch	mm	inch	inch	mm
#									
102HY-2-4	1/8x27	-2	1/4	-4	2.34	59	5/8	1.00	25
102HY-4-4	1/4x18	-4	1/4	-4	2.47	63	11/16	1.13	29
102HY-4-6	1/4x18	-4	3/8	-6	2.48	63	11/16	1.13	29
102HY-6-4	3/8x18	-6	1/4	-4	2.47	63	7/8	1.13	29
102HY-6-6	3/8x18	-6	3/8	-6	2.48	63	7/8	1.13	29
102HY-8-6	1/2x14	-8	3/8	-6	2.75	70	1	1.41	36
102HY-8-8	1/2x14	-8	1/2	-8	2.84	72	1	1.50	38
102HY-12-12	3/4x14	-12	3/4	-12	2.83	72	1-1/4	1.25	32
102HY-16-16	1x11-1/2	-16	1	16	3.27	83	1-1/2	1.66	42

107HY (HY-RV) Female NPSM Pipe Swivel - Straight (60° Cone)

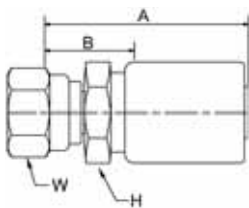

Steel Part Number	Thread Size		Hose I.D.		A		H Hex	W Hex	B	
	inch		inch		inch	mm	inch	inch	inch	mm
#										
107HY-6-6	3/8x18	-6	3/8	-6	2.55	65	3/4	1.19	30	762

105HY (HY-RA) Male SAE Straight Thread with O-Ring - Rigid - Straight

Note: O-Ring is not compatible with Phosphate Ester fluids.

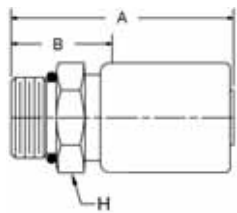

Steel Part Number	Thread Size		Hose I.D.		A		H Hex	Cutoff Allow. B	
#									
Hose Fitting	inch		inch		inch	mm	inch	inch	mm
105HY-4-4	7/16x20	-4	1/4	-4	2.33	59	9/16	0.97	25
105HY-5-4	1/2x20	-5	1/4	-4	2.33	59	5/8	0.97	25
105HY-6-4	9/16x18	-6	1/4	-4	2.42	61	11/16	1.06	27
105HY-6-6	9/16x18	-6	3/8	-6	2.38	60	11/16	1.03	26
105HY-8-6	3/4x16	-8	3/8	-6	2.42	61	7/8	1.06	27
105HY-8-8	3/4x16	-8	1/2	-8	2.59	66	7/8	1.25	32
105HY-10-6	7/8x14	-10	3/8	-6	2.55	65	1	1.19	30
105HY-10-8	7/8x14	-10	1/2	-8	2.66	68	1	1.31	33
105HY-10-10	7/8x14	-10	5/8	-10	2.80	71	1-1/8	1.41	36
105HY-12-8	1-1/16x12	-12	1/2	-8	2.81	71	1-1/4	1.47	37
105HY-12-10	1-1/16x12	-12	5/8	-10	2.83	72	1-1/4	1.44	37
105HY-12-12	1-1/16x12	-12	3/4	-12	2.92	74	1-1/4	1.34	34
105HY-16-12	1-5/16x12	-16	3/4	-12	2.92	74	1-1/2	1.34	34
105HY-16-16	1-5/16x12	-16	1	-16	3.08	78	1-1/2	1.47	37

10GHY (HY-RC) Male SAE Straight Thread with O-Ring - Swivel Straight

Note: The fitting allows minor movement under pressure to relieve stress on hose. It is not to be used for continuous or extensive swiveling.

Note: O-Ring is not compatible with Phosphate Ester fluids.

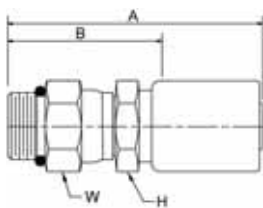

Steel Part Number	Thread Size		Hose I.D.		A		H Hex	W Hex	B	
#										
Hose Fitting	inch		inch		inch	mm	inch	inch	inch	mm
10GHY-4-4	7/16x20	-4	1/4	-4	3.00	76	9/16	5/8	1.66	42
10GHY-5-4	1/2x20	-5	1/4	-4	3.00	76	9/16	5/8	1.66	42
10GHY-6-6	9/16x18	-6	3/8	-6	3.14	80	11/16	11/16	1.78	45
10GHY-8-6	3/4x16	-8	3/8	-6	3.24	82	13/16	7/8	1.88	48
10GHY-8-8	3/4x16	-8	1/2	-8	3.36	85	7/8	7/8	2.00	51
10GHY-10-8	7/8x14	-10	1/2	-8	3.44	87	1	1	2.09	53
10GHY-12-8	1-1/16x12	-12	1/2	-8	3.66	93	1-1/4	1-1/4	2.31	59
10GHY-12-12	1-1/16x12	-12	3/4	-12	3.89	99	1-1/4	1-1/4	2.31	59
10GHY-16-16	1-5/16x12	-16	1	-16	3.95	100	1-3/8	1-1/2	2.34	59

10LHY (HY-RC90) Male SAE Straight Thread with O-Ring - Swivel 90° Elbow

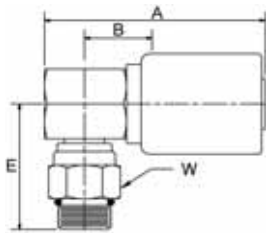

Note: The fitting allows minor movement under pressure to relieve stress on hose. It is not to be used for continuous or extensive swiveling.
 Note: O-Ring is not compatible with Phosphate Ester fluids.

Steel Part Number	Thread Size		Hose I.D.		A		E		W Hex	B	
	inch		inch		inch	mm	inch	mm	inch	inch	mm
#	[Thread Symbol]		[Hose I.D. Symbol]						[Hex Symbol]		
Hose Fitting	inch		inch		inch	mm	inch	mm	inch	inch	mm
10LHY-6-6	9/16x18	-6	3/8	-6	2.33	59	1.66	42	11/16	0.97	25
10LHY-8-6	3/4x16	-8	3/8	-6	2.33	59	1.73	44	7/8	0.97	25
10LHY-8-8	3/4x16	-8	1/2	-8	3.00	76	1.80	46	7/8	1.09	28
10LHY-10-8	7/8x14	-10	1/2	-8	3.00	76	1.88	48	1	1.09	28
10LHY-12-12	1-1/16x12	-12	3/4	-12	2.77	70	2.23	57	1-1/4	1.19	30
10LHY-16-16	1-5/16x12	-16	1	-16	3.03	77	2.40	61	1-1/2	1.41	36

103HY (HY-MJ) Male JIC 37° Rigid - Straight

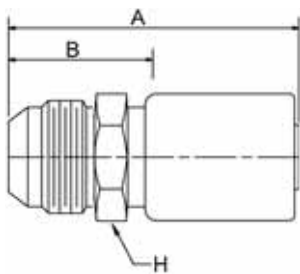

Steel Part Number	Thread Size		Hose I.D.		A		H Hex	Cutoff Allow. B	
	inch		inch		inch	mm	inch	inch	mm
#	[Thread Symbol]		[Hose I.D. Symbol]				[Hex Symbol]		
Hose Fitting	inch		inch		inch	mm	inch	inch	mm
103HY-4-4	7/16x20	-4	1/4	-5	2.52	64	5/8	1.19	30
103HY-5-4	1/2x20	-5	1/4	-4	2.52	64	5/8	1.19	30
103HY-6-4	9/16x18	-6	1/4	-4	2.53	64	11/16	1.19	30
103HY-6-6	9/16x18	-6	3/8	-6	2.54	65	11/16	1.19	30
103HY-6-8	9/16x18	-6	1/2	-8	2.72	69	7/8	1.38	35
103HY-8-6	3/4x16	-8	3/8	-6	2.64	67	13/16	1.28	33
103HY-8-8	3/4x16	-8	1/2	-8	2.81	71	7/8	1.47	37
103HY-10-6	7/8x14	-10	3/8	-6	2.81	71	1	1.47	37
103HY-10-8	7/8x14	-10	1/2	-8	2.91	74	1	1.56	40
103HY-10-10	7/8x14	-10	5/8	-10	2.98	76	1-1/8	1.59	40
103HY-10-12	7/8x14	-10	3/4	-12	3.08	78	1-1/4	1.50	38
103HY-12-8	1-1/16x12	-12	1/2	-8	3.02	77	1-1/8	1.66	42
103HY-12-10	1-1/16x12	-12	5/8	-10	3.09	78	1-1/8	1.72	44
103HY-12-12	1-1/16x12	-12	3/4	-12	3.19	81	1-1/4	1.63	41
103HY-14-12	1-3/16x12	-14	3/4	-12	3.19	81	1-1/4	1.63	41
103HY-16-12	1-5/16x12	-16	3/4	-12	3.23	82	1-3/8	1.66	42
103HY-16-16	1-5/16x12	-16	1	-16	3.39	86	1-3/8	1.78	45

106HY (HY-FJ) Female JIC 37° Swivel - Straight

Note: "C303" - Stainless Steel Fitting

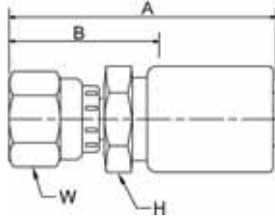

Steel Part Number	Thread Size		Hose I.D.		A		H Hex	W Hex	B	
					inch	mm	inch	inch	inch	mm
#										
Hose Fitting	inch		inch		inch	mm	inch	inch	inch	mm
106HY-3-4	3/8x24	-3	1/4	-4	2.58	66	9/16	1/2	1.22	31
106HY-4-4	7/16x20	-4	1/4	-4	2.60	66	9/16	9/16	1.25	32
106HY-4-4C303	7/16x20	-4	1/4	-4	2.60	66	9/16	9/16	1.25	32
106HY-4-6	7/16x20	-4	3/8	-6	2.67	68	3/4	9/16	1.31	33
106HY-5-4	1/2x20	-5	1/4	-4	2.65	67	9/16	5/8	1.31	33
106HY-5-6	1/2x20	-5	3/8	-6	2.73	69	3/4	5/8	1.38	35
106HY-6-4	9/16x18	-6	1/4	-4	2.67	68	5/8	11/16	1.31	33
106HY-6-6	9/16x18	-6	3/8	-6	2.69	68	11/16	11/16	1.34	34
106HY-6-6C303	9/16x18	-6	3/8	-6	2.69	68	11/16	11/16	1.34	34
106HY-6-8	9/16x18	-6	1/2	-8	2.86	73	7/8	11/16	1.50	38
106HY-8-6	3/4x16	-8	3/8	-6	2.72	69	7/8	7/8	1.38	35
106HY-8-8	3/4x16	-8	1/2	-8	2.90	74	7/8	7/8	1.56	40
106HY-8-8C303	3/4x16	-8	1/2	-8	2.90	74	7/8	7/8	1.56	40
106HY-8-10	3/4x16	-8	5/8	-10	2.98	76	1-1/8	7/8	1.59	40
106HY-8-12	3/4x16	-8	3/4	-10	3.08	78	1-1/4	7/8	1.53	39
106HY-10-6	7/8x14	-10	3/8	-6	2.81	71	7/8	1	1.47	37
106HY-10-8	7/8x14	-10	1/2	-8	2.98	76	1	1	1.63	41
106HY-10-10	7/8x14	-10	5/8	-10	3.06	78	1-1/8	1	1.69	43
106HY-10-12	7/8x14	-10	3/4	-12	3.16	80	1-1/4	1	1.59	40
106HY-12-8	1-1/16x12	-12	1/2	-8	3.05	77	1-1/8	1-1/4	1.69	43
106HY-12-10	1-1/16x12	-12	5/8	-10	3.12	79	1-1/8	1-1/4	1.75	44
106HY-12-12	1-1/16x12	-12	3/4	-12	3.22	82	1-1/4	1-1/4	1.66	42
106HY-12-12C303	1-1/16x12	-12	3/4	-12	3.22	82	1-1/4	1-1/4	1.66	42
106HY-12-16	1-1/16x12	-12	1	-16	3.38	86	1-3/8	1-1/4	1.75	44
106HY-14-12	1-3/16x12	-14	3/4	-12	3.23	82	1-1/4	1 3/8	1.66	42
106HY-16-12	1-5/16x12	-16	3/4	-12	3.30	84	1-3/8	1-1/2	1.72	44
106HY-16-16	1-5/16x12	-16	1	-16	3.45	88	1-3/8	1-1/2	1.84	47
106HY-16-16C303	1-5/16x12	-16	1	-16	3.45	88	1-3/8	1-1/2	1.84	47
106HY-20-16	1-5/8x12	-20	1	-16	3.70	94	1-3/4	2	2.09	53

Hydraulic & Pneumatic Hose & Fit.

PTFE Hose & Fittings

Thermoplastic Tubing

Coiled Air Hose, Fittings & Accessories

Truck (Fleet) Products

Tooling & Equipment

Hose Accessories

Technical & Design Information

Approvals & Guides

Alphanumeric Index



137HY (HY-FJ45T) Female JIC 37° Swivel - 45° Elbow - Short Drop

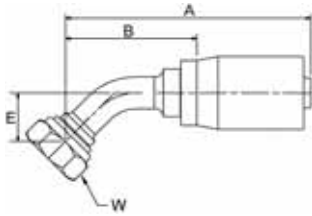

Steel Part Number	Thread Size		Hose I.D.		A		E		W Hex	B	
	inch	mm	inch	mm	inch	mm	inch	mm	inch	mm	
#	[Thread Symbol]		[Hose I.D. Symbol]						[Hex Symbol]		
Hose Fitting	inch		inch		inch	mm	inch	mm	inch	inch	mm
137HY-4-4	7/16x20	-4	1/4	-4	3.24	82	0.33	8	9/16	1.88	48
137HY-5-4	1/2x20	-5	1/4	-4	3.27	83	0.36	9	5/8	1.91	49
137HY-6-4	9/16x18	-6	1/4	-4	3.34	85	0.39	10	3/4	2.00	51
137HY-6-6	9/16x18	-6	3/8	-6	3.33	85	0.39	10	11/16	1.97	50
137HY-8-6	3/4x16	-8	3/8	-6	3.66	93	0.54	14	7/8	2.31	59
137HY-8-8	3/4x16	-8	1/2	-8	3.77	96	0.54	14	7/8	2.41	61
137HY-10-8	7/8x14	-10	1/2	-8	3.41	87	0.63	16	1	2.06	52
137HY-10-10	7/8x14	-10	5/8	-10	3.69	94	0.63	16	1	2.31	59
137HY-12-10	1-1/16x12	-12	5/8	-10	3.94	100	0.77	20	1-1/8	2.56	65
137HY-12-12	1-1/16x12	-12	3/4	-12	3.89	99	0.77	20	1-1/4	2.31	59
137HY-16-12	1-5/16x12	-16	3/4	-12	4.35	110	0.89	23	1-1/2	2.78	71
137HY-16-16	1-5/16x12	-16	1	-16	4.31	109	0.89	23	1-1/2	2.69	68

139HY (HY-FJ90T) Female JIC 37° Swivel - 90° Elbow - Short Drop

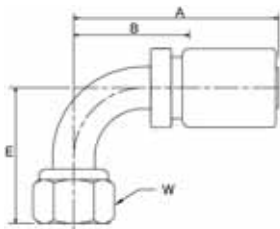

Steel Part Number	Thread Size		Hose I.D.		A		E		W Hex	B	
	inch	mm	inch	mm	inch	mm	inch	mm	inch	mm	
#	[Thread Symbol]		[Hose I.D. Symbol]						[Hex Symbol]		
Hose Fitting	inch		inch		inch	mm	inch	mm	inch	inch	mm
139HY-4-4	7/16x20	-4	1/4	-4	3.13	80	0.69	18	9/16	1.78	45
139HY-5-4	1/2x20	-5	1/4	-4	3.16	80	0.77	20	5/8	1.81	46
139HY-6-4	9/16x18	-6	1/4	-4	3.25	83	0.86	22	3/4	1.91	49
139HY-6-6	9/16x18	-6	3/8	-6	3.23	82	0.86	22	11/16	1.88	48
139HY-8-6	3/4x16	-8	3/8	-6	3.48	88	1.12	28	7/8	2.13	54
139HY-8-8	3/4x16	-8	1/2	-8	3.59	91	1.13	29	7/8	2.25	57
139HY-10-8	7/8x14	-10	1/2	-8	3.11	79	1.23	31	1	1.75	44
139HY-10-10	7/8x14	-10	5/8	-10	3.39	86	1.23	31	1	2.00	51
139HY-10-12	7/8x14	-10	3/4	-12	3.25	83	1.23	31	1	1.69	43
139HY-12-8	1-1/16x12	-12	1/2	-8	3.61	92	1.83	46	1-1/4	2.25	57
139HY-12-10	1-1/16x12	-12	5/8	-10	3.89	99	1.83	46	1-1/4	2.50	64
139HY-12-12	1-1/16x12	-12	3/4	-12	3.84	98	1.83	46	1-1/4	2.28	58
139HY-16-12	1-5/16x12	-16	3/4	-12	4.33	110	2.14	54	1-1/2	2.78	71
139HY-16-16	1-5/16x12	-16	1	-16	4.31	109	2.31	59	1-1/2	2.69	68

141HY (HY-FJ90TL) Female JIC 37° Swivel - 90° Elbow - Long Drop

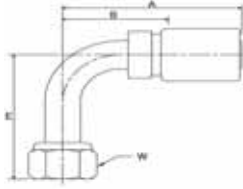

Steel Part Number	Thread Size		Hose I.D.		A		E		W Hex	B	
					inch	mm	inch	mm	inch	inch	mm
#	[Thread Symbol]		[Hose I.D. Symbol]						[Hex Symbol]		
Hose Fitting	inch		inch		inch	mm	inch	mm	inch	inch	mm
141HY-4-4	7/16x20	-4	1/4	-4	3.13	80	1.8	46	9/16	1.78	45
141HY-5-4	1/2x20	-5	1/4	-4	3.16	80	1.77	45	5/8	1.81	46
141HY-6-4	9/16x18	-6	1/4	-4	3.22	82	2.19	56	11/16	1.88	48
141HY-6-6	9/16x18	-6	3/8	-6	3.23	82	2.19	56	11/16	1.88	48
141HY-8-6	3/4x16	-8	3/8	-6	3.48	88	2.44	62	7/8	2.13	54
141HY-8-8	3/4x16	-8	1/2	-8	3.59	91	2.44	62	7/8	2.25	57
141HY-10-8	7/8x14	-10	1/2	-8	3.36	85	2.58	66	1	2.00	51
141HY-12-12	1-1/16x12	-12	3/4	-12	3.59	91	3.73	95	1-1/4	2.03	52
141HY-16-16	1-5/16x12	-16	1	-16	4.56	116	4.33	110	1-1/2	2.94	75

193HY (HY-FJ90) Female JIC 37° Swivel - 90° Elbow - Block

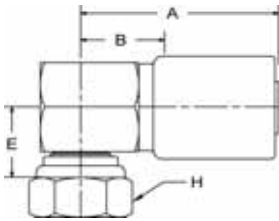

Steel Part Number	Thread Size		Hose I.D.		A		E		W Hex	B	
					inch	mm	inch	mm	inch	inch	mm
#	[Thread Symbol]		[Hose I.D. Symbol]						[Hex Symbol]		
Hose Fitting	inch		inch		inch	mm	inch	mm	inch	inch	mm
193HY-6-6	9/16x18	-6	3/8	-6	2.33	59	0.78	20	11/16	0.97	25
193HY-8-8	3/4x16	-8	1/2	-8	3.00	76	0.85	22	7/8	1.09	28
193HY-10-8	7/8x14	-10	1/2	-8	3.00	76	0.89	23	1	1.09	28
193HY-10-12	7/8x14	-10	3/4	-12	3.25	83	0.96	24	1	1.19	30
193HY-12-12	1-1/16x12	-12	3/4	-12	3.33	85	0.99	25	1-1/4	1.19	30

108HY (HY-FA) Female SAE 45° Swivel - Straight

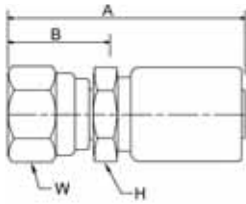

Steel Part Number	Thread Size		Hose I.D.		A		H Hex	W Hex	B	
	inch		inch		inch	mm	inch	inch	inch	mm
#										
108HY-4-4	7/16x20	-4	1/4	-4	2.60	66	9/16	9/16	1.26	32
108HY-5-4	1/2x20	-5	1/4	-4	2.66	68	9/16	5/8	1.31	33
108HY-6-4	5/8x18	-6	1/4	-4	2.73	69	11/16	3/4	1.38	35
108HY-6-6	5/8x18	-6	3/8	-6	2.75	70	11/16	3/4	1.41	36
108HY-8-6	3/4x16	-8	3/8	-6	2.73	69	13/16	7/8	1.38	35
108HY-8-8	3/4x16	-8	1/2	-8	2.90	74	7/8	7/8	1.56	40
108HY-10-8	7/8x14	-10	1/2	-8	2.98	76	1	1	1.63	41

177HY (HY-FA45T) Female SAE 45° Swivel - 45° Elbow

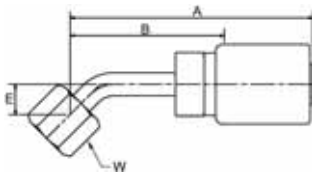

Steel Part Number	Thread Size		Hose I.D.		A		E		W Hex	B	
	inch		inch		inch	mm	inch	mm	inch	inch	mm
#											
177HY-5-6	1/2x20	-5	3/8	-6	3.28	83	0.36	9	5/8	1.94	49
177HY-6-6	5/8x18	-6	3/8	-6	3.33	85	0.39	10	3/4	1.97	50

179HY (HY-FA90T) Female SAE 45° Swivel - 90° Elbow

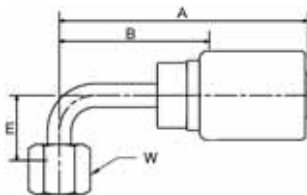

Steel Part Number	Thread Size		Hose I.D.		A		E		W Hex	B	
	inch		inch		inch	mm	inch	mm	inch	inch	mm
#											
179HY-4-6	7/16x20	-4	3/8	-6	3.08	78	0.69	18	9/16	1.72	44
179HY-6-6	5/8x18	-6	3/8	-6	3.23	82	0.86	22	3/4	1.88	48
179HY-12-12	1-1/16x14	-12	3/4	-12	3.98	101	1.83	46	1-1/4	2.39	61

111HY (HY-MV, HY-MH and HY-MM) Male Ferulok® Flareless - Rigid - Straight (24° Cone w/Nut and Ferrule)

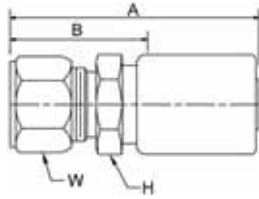

Steel Part Number	Thread Size		Hose I.D.		A		H Hex	W Hex	B	
#										
Hose Fitting	inch		inch		inch	mm	inch	inch	inch	mm
111HY-4-4	7/16x20	-4	1/4	-4	2.42	61	9/16	9/16	1.06	27
111HY-4-6	7/16x20	-4	3/8	-6	2.44	62	3/4	9/16	1.09	28
111HY-5-6	1/2x20	-5	3/8	-6	2.44	62	3/4	5/8	1.09	28
111HY-6-4	9/16x18	-6	1/4	-4	2.44	62	5/8	11/16	1.09	28
111HY-6-6	9/16x18	-6	3/8	-6	2.45	62	11/16	11/16	1.09	28
111HY-8-6	3/4x16	-8	3/8	-6	2.61	66	7/8	7/8	1.25	32
111HY-8-8	3/4x16	-8	1/2	-8	2.72	69	7/8	7/8	1.38	35
111HY-10-8	7/8x14	-10	1/2	-8	2.78	71	1	1	1.44	37
111HY-12-12	1-1/16x12	-12	3/4	-12	3.02	77	1-1/4	1-1/4	1.44	37
111HY-16-16	1-5/16x12	-16	1	-16	3.17	81	1	1-1/2	1.56	40

1GJHY (HY-NV) Female Grease Connection - Special PTF Taper Thread - Rigid - Straight - 1/2x27

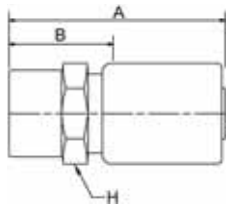

Steel Part Number	Thread Size		Hose I.D.		A		H Hex	Cutoff Allow. B	
#									
Hose Fitting	inch		inch		inch	mm	inch	inch	mm
1GJHY-8-4	1/2x27	-8	1/4	-4	2.41	61	3/4	1.06	27

134HY (HY-RL) Male Standpipe Rigid - Straight (Inch Size Tube O.D.)

Note: 134HY requires the use of Ferrule nut (BU), Ferrule (TU), and Ferulok® Fittings.

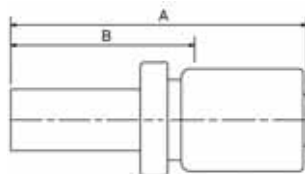

Steel Part Number	R		Hose I.D.		A		B	
#								
Hose Fitting	mm		inch		inch	mm	inch	mm
134HY-4-4	1/4	-4	1/4	-4	3.03	77	1.69	43
134HY-6-4	3/8	-6	1/4	-4	3.16	80	1.81	46
134HY-6-6	3/8	-6	3/8	-6	3.17	81	1.81	46
134HY-8-6	1/2	-8	3/8	-6	3.33	85	1.97	50
134HY-8-8	1/2	-8	1/2	-8	3.44	87	2.09	53
134HY-10-8	5/8	-10	1/2	-8	3.66	93	2.31	59
134HY-12-10	3/4	-12	5/8	-10	3.80	97	2.41	61
134HY-12-12	3/4	-12	3/4	-12	3.89	99	2.31	59
134HY-16-16	1	-16	1	-16	4.23	107	2.63	67

128HY (HY-MF) Male Inverted SAE 45° Swivel - Straight

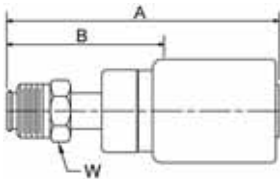

Steel Part Number	Thread Size		Hose I.D.		A		W Hex		Cutoff Allow. B	
#										
Hose Fitting	inch		inch		inch	mm	inch	mm	inch	mm
128HY-3-4	3/8x24	-3	1/4	-4	3.09	78	3/8	1.75	44	
128HY-4-4	7/16x24	-4	1/4	-4	3.28	83	7/16	1.94	49	
128HY-5-4	1/2x20	-5	1/4	-4	3.34	85	1/2	2.00	51	
128HY-5-6	1/2x20	-5	3/8	-6	3.17	81	1/2	1.81	46	
128HY-6-6	5/8x18	-6	3/8	-6	3.73	95	5/8	2.38	60	
128HY-8-6	3/4x18	-8	3/8	-8	3.42	87	3/4	2.06	52	
128HY-8-8	3/4x18	-8	1/2	-8	3.66	93	3/4	2.31	59	

167HY (HY-MF45T) Male Inverted SAE 45° - Swivel - 45° Elbow

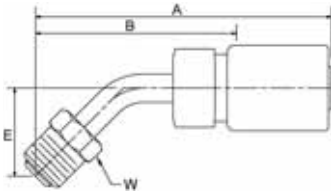

Steel Part Number	Thread Size		Hose I.D.		A		E		W Hex		B	
#												
Hose Fitting	inch		inch		inch	mm	inch	mm	inch	mm	inch	mm
167HY-3-4	3/8x24	-3	1/4	-4	3.03	77	0.72	18	3/8	1.69	43	
167HY-4-4	7/16x24	-4	1/4	-4	3.31	84	0.78	20	7/16	1.97	50	
167HY-4-6	7/16x24	-4	3/8	-6	3.14	80	0.78	20	7/16	1.78	45	
167HY-5-4	1/2x20	-5	1/4	-4	3.55	90	0.88	22	1/2	2.19	56	
167HY-5-6	1/2x20	-5	3/8	-6	3.38	86	0.88	22	1/2	2.03	52	
167HY-6-6	5/8x18	-6	3/8	-6	4.16	106	0.94	24	5/8	2.81	71	
167HY-8-8	3/4x18	-8	1/2	-8	4.22	107	1.06	27	3/4	2.88	73	

169HY (HY-MF90T) Male Inverted SAE 45° - Swivel - 90° Elbow

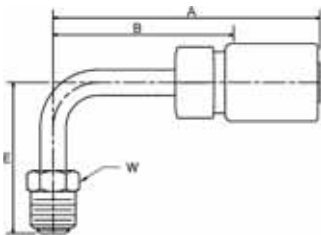

Steel Part Number	Thread Size		Hose I.D.		A		E		W Hex		B	
#												
Hose Fitting	inch		inch		inch	mm	inch	mm	inch	mm	inch	mm
169HY-3-4	3/8x24	-3	1/4	-4	3.09	78	1.38	35	3/8	1.75	44	
169HY-4-4	7/16x24	-4	1/4	-4	3.28	83	1.47	37	7/16	1.94	49	
169HY-4-6	7/16x24	-4	3/8	-6	3.11	79	1.47	37	7/16	1.75	44	
169HY-5-4	1/2x20	-5	1/4	-4	3.52	89	1.66	42	1/2	2.16	55	
169HY-5-6	1/2x20	-5	3/8	-6	3.34	85	1.66	42	1/2	2.00	51	
169HY-6-6	5/8x18	-6	3/8	-6	4.03	102	1.69	43	5/8	2.69	68	
169HY-7-6	11/16x18	-7	3/8	-6	4.16	106	1.69	43	11/16	2.81	71	
169HY-8-6	3/4x18	-8	3/8	-6	4.05	103	1.88	48	3/4	2.72	69	
169HY-8-8	3/4x18	-8	1/2	-8	4.09	104	1.88	48	3/4	2.75	70	

129HY (HY-NG) Female Inverted SAE 45° - Rigid - Straight

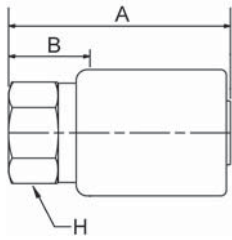

Steel Part Number	Thread Size		Hose I.D.		A		H Hex	Cutoff Allow. B	
					inch	mm	inch	inch	mm
#									
Hose Fitting	inch		inch		inch	mm	inch	inch	mm
129HY-4-4	7/16x24	-4	1/4	-4	2.16	55	9/16	0.81	21
129HY-5-4	1/2x20	-5	1/4	-5	2.25	57	5/8	0.91	23
129HY-6-6	5/8x18	-6	3/8	-6	2.25	57	7/8	0.91	23

1J0HY (HY-OM) Male Seal-Lok™ Rigid - Straight (with O-Ring)

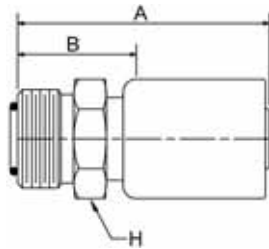

Steel Part Number	Thread Size		Hose I.D.		A		H Hex	Cutoff Allow. B	
					inch	mm	inch	inch	mm
#									
Hose Fitting	inch		inch		inch	mm	inch	inch	mm
1J0HY-4-4	9/16x18	-4	1/4	-4	2.36	60	5/8	1.00	25
1J0HY-6-6	11/16x16	-6	3/8	-6	2.49	63	3/4	1.13	29
1J0HY-8-8	13/16x16	-8	1/2	-8	2.69	68	7/8	1.34	34
1J0HY-12-8	1-3/16x12	-12	1/2	-8	2.91	74	1-1/4	1.56	40

1JCHY (HY-OF) Female Seal-Lok™ Swivel - Straight - Short

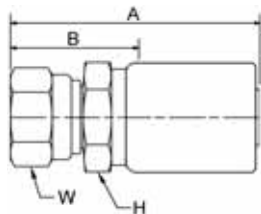

Steel Part Number	Thread Size		Hose I.D.		A		H Hex	W Hex	B	
					inch	mm	inch	inch	inch	mm
#										
Hose Fitting	inch		inch		inch	mm	inch	inch	inch	mm
1JCHY-4-4	9/16x18	-4	1/4	-4	2.61	66	9/16	11/16	0.94	24
1JCHY-6-6	11/16x16	-6	3/8	-6	2.69	68	11/16	13/16	0.94	24
1JCHY-8-8	13/16x16	-8	1/2	-8	2.91	74	7/8	15/16	1.13	29
1JCHY-12-12	1-3/16x12	-12	3/4	-12	3.31	84	1-1/4	1-3/8	1.13	29

1JSHY (HY-OFT) Female Seal-Lok™ Swivel - Straight - Long ISO 12151-1 - SWSB

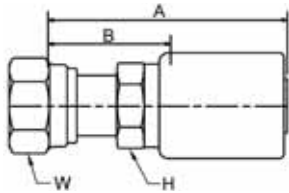

Steel Part Number	Thread Size		Hose I.D.		A		H Hex	W Hex	B	
	inch		inch		inch	mm	inch	inch	inch	mm
#										
Hose Fitting	inch		inch		inch	mm	inch	inch	inch	mm
1JSHY-4-4	9/16x18	-4	1/4	-4	2.59	66	9/16	11/16	1.25	32
1JSHY-6-4	11/16x16	-6	1/4	-4	2.67	68	5/8	13/16	1.31	33
1JSHY-6-6	11/16x16	-6	3/8	-6	2.75	70	11/16	13/16	1.34	34
1JSHY-6-8	11/16x16	-6	1/2	-8	2.87	73	7/8	15/16	1.53	39
1JSHY-8-6	13/16x16	-8	3/8	-6	2.84	72	7/8	15/16	1.50	38
1JSHY-8-8	13/16x16	-8	1/2	-8	2.95	75	7/8	15/16	1.59	40
1JSHY-10-8	1x14	-10	1/2	-8	3.16	80	15/16	1-1/8	1.81	46
1JSHY-10-10	1x14	-10	5/8	-10	3.17	81	1-1/8	1-1/8	1.78	45
1JSHY-10-12	1x14	-10	3/4	-12	3.27	83	1-1/4	1-1/8	1.69	43
1JSHY-12-10	1-3/16x12	-12	5/8	-10	3.20	81	1-1/8	1-3/8	1.81	46
1JSHY-12-12	1-3/16 x12	-12	3/4	-12	3.30	84	1-1/4	1-3/8	1.72	44
1JSHY-16-12	1-7/16x12	-16	3/4	-12	3.44	87	1-3/8	1-5/8	1.88	48
1JSHY-16-16	1-7/16x12	-16	1	-16	3.59	91	1-3/8	1-5/8	1.97	50
1JSHY-20-16	1-11/16x12	-20	1	-16	3.47	88	1-5/8	1-7/8	2.31	59

1J7HY (HY-OF45T) Female Seal-Lok™ Swivel - 45° Elbow ISO 12151-1 - SWE45

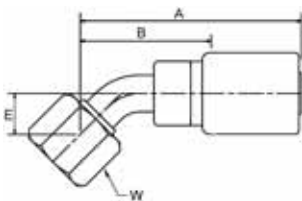

Steel Part Number	Thread Size		Hose I.D.		A		E		W Hex	B	
	inch		inch		inch	mm	inch	mm	inch	inch	mm
#											
Hose Fitting	inch		inch		inch	mm	inch	mm	inch	inch	mm
1J7HY-4-4	9/16x18	-4	1/4	-4	3.22	82	0.4	10	11/16	1.88	48
1J7HY-6-4	11/16x16	-6	1/4	-4	3.31	84	0.44	11	13/16	1.97	50
1J7HY-6-6	11/16x16	-6	3/8	-6	3.23	82	0.44	11	13/16	1.88	48
1J7HY-6-8	11/16x16	-6	1/2	-8	3.41	87	0.44	11	13/16	2.06	52
1J7HY-8-6	13/16x16	-8	3/8	-6	3.37	86	0.56	14	15/16	2.03	52
1J7HY-8-8	13/16x16	-8	1/2	-8	3.34	85	0.56	14	15/16	2.00	51
1J7HY-10-8	1x14	-10	1/2	-8	3.58	91	0.69	18	1-1/8	2.22	56
1J7HY-10-10	1x14	-10	5/8	-10	3.59	91	0.69	18	1-1/8	2.22	56
1J7HY-12-10	1-3/16x12	-12	5/8	-10	4.11	104	0.83	21	1-3/8	2.72	69
1J7HY-12-12	1-3/16x12	-12	3/4	-12	4.00	102	0.83	21	1-3/8	2.44	62
1J7HY-16-12	1-7/16x12	-16	3/4	-12	4.39	112	0.97	25	1-5/8	2.84	72
1J7HY-16-16	1-7/16x12	-16	1	-16	4.55	116	0.97	25	1-5/8	2.94	75

1J9HY (HY-OF90T) Female Seal-Lok™ Swivel - 90° Elbow - Short Drop ISO 12151-1 - SWES90

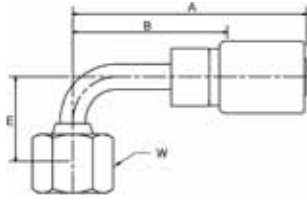

Steel Part Number	Thread Size		Hose I.D.		A		E		W Hex	B	
	inch		inch		inch	mm	inch	mm	inch	inch	mm
#											
Hose Fitting	inch		inch		inch	mm	inch	mm	inch	inch	mm
1J9HY-4-4	9/16x18	-4	1/4	-4	3.06	78	.83	21	11/16	1.72	44
1J9HY-4-6	9/16x18	-4	3/8	-6	3.08	78	.83	21	11/16	1.72	44
1J9HY-6-4	11/16x16	-6	1/4	-4	3.20	81	.95	24	13/16	1.84	47
1J9HY-6-6	11/16x16	-6	3/8	-6	3.13	80	.95	24	13/16	1.72	44
1J9HY-6-8	11/16x16	-6	1/2	-8	3.30	84	.95	24	13/16	1.94	49
1J9HY-8-6	13/16x16	-8	3/8	-6	3.19	81	1.16	29	15/16	1.84	47
1J9HY-8-8	13/16x16	-8	1/2	-8	3.16	80	1.16	29	15/16	1.81	46
1J9HY-10-8	1x14	-10	1/2	-8	3.47	88	1.33	34	1 1/8	2.13	54
1J9HY-10-10	1x14	-10	5/8	-10	3.42	87	1.33	34	1 1/8	2.03	52
1J9HY-12-10	1 3/16x12	-12	5/8	-10	3.91	99	1.91	49	1 3/8	2.53	64
1J9HY-12-12	1 3/16x12	-12	3/4	-12	3.92	100	1.91	49	1 3/8	2.34	59
1J9HY-16-12	1 7/16x12	-16	3/4	-12	4.27	108	2.25	57	1 5/8	2.69	68
1J9HY-16-16	1 7/16x12	-16	1	-16	4.45	113	2.25	57	1 5/8	2.84	72

1J1HY (HY-OF90TL) Female Seal-Lok™ Swivel - 90° Elbow Long Drop - ISO 12151-1 - SWEL90

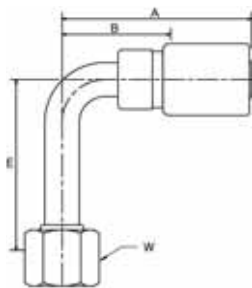

Steel Part Number	Thread Size		Hose I.D.		A		E		W Hex	B	
	inch		inch		inch	mm	inch	mm	inch	inch	mm
#											
Hose Fitting	inch		inch		inch	mm	inch	mm	inch	inch	mm
1J1HY-4-4	9/16x18	-4	1/4	-4	3.06	78	1.80	46	11/16	1.72	44
1J1HY-6-6	11/16x16	-6	3/8	-6	3.13	80	2.13	54	13/16	1.72	44
1J1HY-8-8	13/16x16	-8	1/2	-8	3.16	80	2.50	64	15/16	1.81	46
1J1HY-10-8	1x14	-10	1/2	-8	3.41	87	2.77	70	1-1/8	1.81	46
1J1HY-10-10	1x14	-10	5/8	-10	3.42	87	2.77	70	1-1/8	2.03	52
1J1HY-12-12	1-3/16x12	-12	3/4	-12	3.95	100	3.83	97	1-3/8	2.38	60
1J1HY-16-16	1-7/16x12	-16	1	-16	4.45	113	4.50	114	1-5/8	2.84	72

1D0HY (HY-MZ) Male Metric L - Rigid Straight (24° Cone) - ISO 8434-1

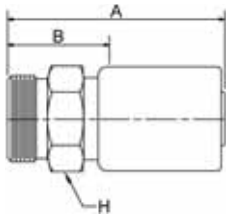

Steel Part Number	Thread Size		Hose I.D.		A		H Hex	Cutoff Allow. B	
	#		[Symbol]		[Symbol]		[Symbol]	[Symbol]	
Hose Fitting	inch		inch		inch	mm	inch	inch	mm
1D0HY-6-4	6	M12x1.5	-6	1/4	-4	2.36	60	14	1.00
1D0HY-8-4	8	M14x1.5	-8	1/4	-4	2.36	60	17	1.00
1D0HY-10-4	10	M16x1.5	-10	1/4	-4	2.40	61	19	1.03
1D0HY-10-6	10	M16x1.5	-10	3/8	-6	2.42	61	19	1.06
1D0HY-12-6	12	M18x1.5	-12	3/8	-6	2.42	61	22	1.06
1D0HY-15-6	15	M22x1.5	-15	3/8	-6	2.52	64	24	1.16
1D0HY-15-8	15	M22x1.5	-15	1/2	-8	2.63	67	24	1.28
1D0HY-18-10	18	M26x1.5	-18	5/8	-10	2.71	69	27	1.31
1D0HY-22-12	22	M30x2.0	-22	3/4	-12	2.88	73	32	1.31
1D0HY-28-16	28	M36x2.0	-28	1	-16	3.04	77	41	1.41

13DHY (HY-RZT) Male Standpipe Metric S - Rigid - Straight ISO 8434-1

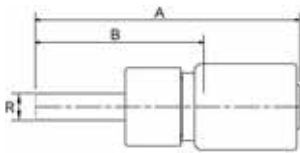

Steel Part Number	R		Hose I.D.		A		B	
	#		[Symbol]		[Symbol]		[Symbol]	
Hose Fitting	mm		inch		inch	mm	inch	mm
13DHY-16-8	16	-16	1/2	-8	3.53	90	2.16	55
13DHY-20-10	20	-20	5/8	-10	3.62	92	2.22	56
13DHY-25-12	25	-25	3/4	-12	3.79	96	2.22	56

1D9HY (HY-BP) Male BSP Parallel Pipe - Rigid - Straight (60° Cone) ISO 228-1

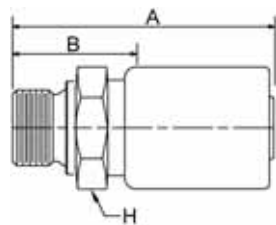

Steel Part Number	Thread Size		Hose I.D.		A		H Hex	Cutoff Allow. B	
	#		[Symbol]		[Symbol]		[Symbol]	[Symbol]	
Hose Fitting	inch		inch		inch	mm	inch	inch	mm
1D9HY-4-4	1/4x19	-4	1/4	-4	2.40	61	13/16	1.03	26
1D9HY-6-6	3/8x19	-6	3/8	-6	2.55	65	7/8	1.19	30
1D9HY-8-8	1/2x14	-8	1/2	-8	2.83	72	1-1/16	1.47	37
1D9HY-12-12	3/4x14	-12	3/4	-12	3.09	78	1-5/16	1.50	38
1D9HY-16-16	1x11	-16	1	-16	3.31	84	1-9/16	1.69	43

1GUHY (HY-BPF) Female BSP Parallel Pipe - Swivel - Straight (60° Flare) ISO 228-1

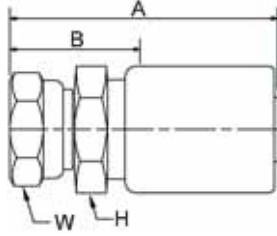

Steel Part Number	Thread Size		Hose I.D.		A		H Hex	W Hex	B	
	inch		inch		inch	mm	inch	inch	inch	mm
#										
Hose Fitting	inch		inch		inch	mm	inch	inch	inch	mm
1GUHY-2-4	1/8x28	-2	1/4	-4	2.51	64	14	14	1.16	29
1GUHY-4-4	1/4x19	-4	1/4	-4	2.62	67	14	17	1.28	33
1GUHY-4-6	1/4x19	-4	3/8	-6	2.64	67	19	17	1.28	33
1GUHY-6-4	3/8x19	-6	1/4	-4	2.69	68	19	22	1.34	34
1GUHY-6-6	3/8x19	-6	3/8	-6	2.70	69	19	22	1.34	34
1GUHY-8-8	1/2x14	-8	1/2	-8	3.02	77	22	25	1.66	42
1GUHY-10-10	5/8x14	-10	5/8	-10	3.09	78	27	29	1.72	44
1GUHY-12-12	3/4x14	-12	3/4	-12	3.25	83	32	32	1.69	43
1GUHY-16-16	1x11	-16	1	-16	3.45	88	35	38	1.84	47

1UTHY (HY-BT) Male BSP Taper Pipe Rigid - Straight

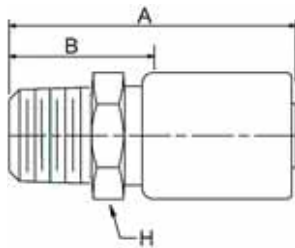

Steel Part Number	Thread Size		Hose I.D.		A		H Hex	Cutoff Allow. B	
	inch		inch		inch	mm	inch	inch	mm
#									
Hose Fitting	inch		inch		inch	mm	inch	inch	mm
1UTHY-4-4	1/4x19	-4	1/4	-4	2.53	64	9/16	1.19	30
1UTHY-6-4	3/8x19	-6	1/4	-4	2.53	64	11/16	1.19	30
1UTHY-6-6	3/8x19	-6	3/8	-6	2.55	65	11/16	1.19	30
1UTHY-8-6	1/2x14	-8	3/8	-6	2.73	69	7/8	1.38	35
1UTHY-8-8	1/2x14	-8	1/2	-8	2.91	74	7/8	1.56	40
1UTHY-12-12	3/4x14	-12	3/4	-12	3.08	78	1-1/4	1.50	38
1UTHY-16-16	1x11	-16	1	-16	3.42	87	1-3/8	1.82	46

1XUHY (HY-KMF) Female Metric Swivel - Straight (30° Flare)

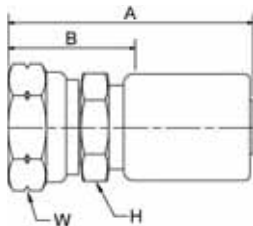

Steel Part Number	Thread Size		Hose I.D.		A		H Hex	W Hex	B	
	inch		inch		inch	mm	inch	inch	inch	mm
#										
Hose Fitting	inch		inch		inch	mm	inch	inch	inch	mm
1XUHY-24-8	24	M24x1.5	-24	1/2	-8	3.14	80	22	30	1.72
1XUHY-24-10	24	M24x1.5	-24	5/8	10	3.22	82	30	30	1.84
1XUHY-30-12	30	M30x1.5	-30	3/4	-12	3.31	84	32	38	1.75

PTFE Hose & Fittings

Tutorial, Introduction & Benefits 130-131

PTFE Hose Assembly & Fittings Nomenclature 132

Smooth Bore Hose

919 – SAE 100R14A Hose 133

919B – SAE 100R14B Hose (Static-Dissipative Tube)..... 133

919J – SAE 100R14A Performance, Silicone Jacket 134

919U – SAE 100R14 Performance, Urethane Jacket..... 135

929 – SAE 100R14 Performance, Heavy Wall 136

929B – SAE 100R14 Performance, Heavy Wall (Static-Dissipative Tube) 136

929BJ – SAE 100R14 Performance, Heavy Wall (Static-Dissipative Tube),
Silicone Jacket 137

943B – 3000 PSI W.P., High Temperature Hydraulic Hose 139

950B – 4000 PSI W.P., High Temperature Hydraulic Hose 139

Convoluted Hose

939 - PTFE Convoluted Tube Hose 138

939B - PTFE Convoluted Tube Hose (Static-Dissipative Tube) 138

Permanent & Field Attachable Hose Fittings

Visual Index 140-141

90 Series - Field Attachable Fittings for 919 Series PTFE Hose 142-149

91N Series - Crimp Fittings for 919 & 929 Series PTFE Hose 150-164

93N/ 96N Fittings - Crimp Fittings for 939 Series Hose 165-168

94/95 Series - Factory Crimp Fittings for 943B & 950B Series PTFE Hose 169





PTFE Hoses Tutorial

- Familiarize yourself with the definition and operating characteristics of PTFE hose- general, features, advantages, and benefits follow
- The **STAMPED** guide on **page 131** is provided as your template for the gathering of information to help you in selecting a hose
- Review the information pertaining to static dissipation (electrical dissipation) - it may be pertinent to your application
- Review the **symbols on page ii** and **nomenclature information on page 132** - this will clear up any questions on assemblies and component call outs- examples are provided
- PTFE hose are often used for the conveyance of chemicals –please refer to our general chemical compatibility guide in the technical section guide- feel free to contact our technical department if you have concerns
- A visual index of PTFE fittings follows the hose portion of this section- this will help you quickly determine what configurations are available

PTFE Fittings visual index starts on page 140.

NOTE: If higher or lower temperature requirements are required please refer to our **Metal Hose Catalog 4660-MH1**

Tubing made of PTFE and other fluoropolymer materials may be found in. **Atlantic Tubing Catalog 4150**

What is PTFE and why is it a superior hose core material?

PTFE (Polytetrafluoroethylene) is a high-performance fluoroplastic with high crystallinity and high molecular weight. Discovered in 1938 by DuPont chemist, Dr. Roy J. Plunkett. PTFE is more commonly known as Teflon®, the DuPont trade name for PTFE. Parflex PTFE hose provides fluid conveyance solutions for a wide array of markets and applications because of the unique properties of PTFE:

Chemical Resistance – inert to virtually all chemicals

Extreme Temperature Ranges – 65F to 500F

Low friction – Minimizes pressure drop and deposits on hose.

Non-Stick - Easier to clean

Flexible – convoluted designs have excellent bend radius properties

Resists Moisture

Unlimited Shelf Life





How To Select A Hose (STAMPED)

Size	The appropriate inside and outside diameters and length of the hose should be determined
Temperature	The maximum temperature of the material being conveyed
Application	External conditions including abrasion, climate, heat, flexing, internal vacuum, and degrees of bending
Media	The composition of the substance being conveyed and chemical compatibility with the hose inner core, and if applicable, outer jacket
Pressure	The maximum pressure of the system, including pressure spikes
Ends	The appropriate end connection and attachment method for the application
Delivery	Testing, quality, packaging, and delivery requirements

NOTE: Static dissipation and PTFE hoses

In the case of a PTFE hose, static electricity is caused when a non-conducting fluid flows at a high velocity through the PTFE natural core tube. When a static charge builds up in the tube of a PTFE hose, it will look for the path of least resistance to ground. If the tube is non-conductive, then the path of least resistance may be to pierce through the wall of the PTFE tube to the conductive stainless steel braid and eventually to the metal fittings and back to ground through the equipment to which the hose assembly is connected.

The purpose of a static dissipating tube on the inside of the hose is to provide an acceptable path of less resistance and allow the static buildup to dissipate through the core tube to the metal fittings and eventually to ground. Parflex static-dissipating hose is designated with a B after the series number. Example: Hose type 919B-6 is the static-dissipative version of hose type 919-6.

Hose Assembly Nomenclature

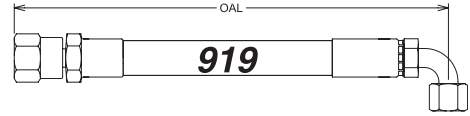

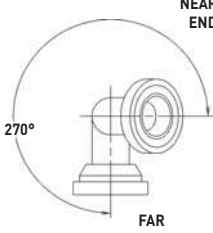
P	919	06	39	08	08	08	C	30	N/A
Prefix	Hose Type	Fitting 1st End Configuration	Fitting 2nd End Configuration	Size 1st End	Size 2nd End	Hose End Dash Size	Fitting Material	Length	Displacement Angle
R= Field Attachable Fitting P= Permanent Crimp 91N & 93N Series F= 91 Series Crimp							Blank= Steel C= Stainless B= Brass	Overall Length always expressed in inches If elbow fittings are used overall length is measured from the centerline of the seat	Specified only if two elbow fittings are used. Starting with either end as the far end, measure the angle clockwise to describe the displacement of the near end. 

This assembly example reflects a 13/32" [-8] ID 919 hose with an SAE 1/2" female JIC 37° straight fitting on the first end and an SAE 1/2" 90° female JIC 37° elbow fitting on the other. The fittings are crimped (permanently attached) and stainless steel. The overall length is 30".

The first fitting part number is 10691N-8-8
The second fitting part number is 13991N-8-8

Special Notes

Assemblies are to be measured extreme end to end. Exceptions:

1. Face seal type fittings shall be measured from sealing face.
2. Where elbow fittings are used, measurement shall be to the centerline of the sealing surface of the elbow end.
3. "A-LOK" and "CPI" fittings are measured from the tube stops.

Hose Fittings Nomenclature

1	03	91N	8	6	
Type	End Configuration Code	Series of Fitting	End Size	Hose Size	Material
1=Crimp 2=Field Attachable					Blank=Steel or Brass/ Steel B=All Brass C=Stainless Steel S= All Carbon Steel

This example describes a permanent crimp 1/2" Male SAE JIC 37° hose end with a 5/16" hose end-this commonly referred to as a "jump size". This fitting is constructed from carbon steel since the designated material is blank.

The callout is: **10391N-8-6**

Other end configuration codes found on page 40.

919 PTFE Hose Exceeds SAE 100R14A



Part Number	Hose I. D.		Max. Hose O. D.		Tube Wall	Max. Working Pressure		Min. Bend Radius		Vac. Rating	Weight		Crimp Fitting		80C Crimp Die	Field Attachable Fitting	
	#	inch	mm	inch		mm	wpsi	MPa	inch		mm	inch/Hg.	lbs/ft	kg/m		series	pg
919-3 (+)	1/8	3	1/4	6	.030	3000	20.7	1.5	38	28	.038	5.7	91	150-164	T03		
919-4	3/16	5	5/16	8	.030	3000	20.7	2.0	51	28	.059	8.9	91N	150-164	T04N	90	142-149
919-5	1/4	6	3/8	10	.030	3000	20.7	3.0	76	28	.086	12.7	91N	150-164	T05N	90	142-149
919-6	5/16	8	7/16	11	.030	2500	17.2	4.0	102	28	.103	15.3	91N	150-164	T06N	90	142-149
919-8	13/32	10.5	17/32	14	.030	2000	13.8	5.0	127	28	.126	18.8	91N	150-164	T08N	90	142-149
919-10	1/2	12.5	5/8	16	.030	1500	10.3	6.5	165	28	.149	22.1	91N	150-164	T10N	90	142-149
919-12	5/8	16	3/4	19	.030	1200	8.3	7.5	191	12	.186	27.7	91N	150-164	T12N	90	142-149
919-16	7/8	22	1-1/32	26	.035	1000	6.9	9.0	229	14	.268	39.9	91N	150-164	T16N	90	142-149
919-20	1-1/8	29	1-9/32	33	.042	625	4.3	16.0	406	10	.388	57.7	91	150-164	T20	90	142-149

Min. Burst Pressure is 4x Max. Working Pressure

Tube: Natural FDA Compliant PTFE

Reinforcement: 304 Stainless Steel

Temperature: -100°F to +450°F
-73°C to +232°C

Change in length at working pressure is +2% to -4%.

Applications:

- Transfer lines for nearly all chemicals
- Hot oils
- Compressed Air/Gases
- Coolant Lines
- Adhesive dispensing
- Medical Gases

*Use hose type 919B with static-dissipative core tube when conveying non-conducting fluids such as oils, paints, fuels, steam, etc..

919B PTFE Hose with Static-Dissipative Tube Exceeds SAE 100R14B



Part Number	Hose I. D.		Max. Hose O. D.		Tube Wall	Max. Working Pressure		Min. Bend Radius		Vac. Rating	Weight		Crimp Fitting		80C Crimp Die	Field Attachable Fitting	
	#	inch	mm	inch		mm	wpsi	MPa	inch		mm	inch/Hg.	lbs/ft	kg/m		series	pg
919B-5	1/4	6	3/8	10	.030	3000	20.7	3.0	76	28	.086	12.7	91N	150-164	T05N	90	142-149
919B-6	5/16	8	7/16	11	.030	2500	17.2	4.0	102	28	.103	15.3	91N	150-164	T06N	90	142-149
919B-8	13/32	10	17/32	14	.030	2000	13.8	5.0	127	28	.126	18.8	91N	150-164	T08N	90	142-149

Min. Burst Pressure is 4x Max. Working Pressure

Tube: Black Static-Dissipative PTFE

Reinforcement: 304 Stainless Steel

Temperature: -100°F to +450°F
-73°C to +232°C

Change in length at working pressure is +2% to -4%.

Applications:

- Transfer lines for nearly all chemicals
- Hot oils
- Compressed Air/Gases
- Adhesive dispensing
- Paints/Coatings
- Fuel Lines
- Coolant Lines
- Steam Transfer

(+) Non Standard. See page ii for information on non-standard products.



919J Silicone Jacketed PTFE Hose Exceeds SAE 100R14A Performance



Part Number	Hose I. D.		Max. Hose O. D.		Tube Wall	Max. Working Pressure		Min. Bend Radius		Vacuum Rating	Weight		Crimp Fitting		80C Crimp Die
	#	inch	mm	inch		mm	wpsi	MPa	inch		mm	lbs/ft	kg/m	series	
919J-4-RED	3/16	5	0.45	11	.030	3000	21	2.0	51	28	.124	18.4	91N	150-164	T04J
919J-5-RED (+)	1/4	6.3	0.52	13	.030	3000	21	3.0	76	28	.142	21.1	91N	150-164	T05J
919J-6-RED	5/16	8	0.58	15	.030	2500	17	4.0	102	28	.165	24.5	91N	150-164	T06J
919J-8-RED	13/32	10	0.68	17	.030	2000	14	5.0	127	28	.202	30.3	91N	150-164	T08J
919J-10-RED	1/2	12.5	0.78	20	.030	1500	10	6.5	165	28	.236	35.2	91N	150-164	T10J
919J-12-RED	5/8	16	0.91	23	.030	1200	8	7.5	191	12	.291	43.2	91N	150-164	T12J

Min. Burst Pressure is 4x Max. Working Pressure

Tube: Natural FDA Compliant PTFE

Reinforcement: 304 Stainless Steel

Cover: Red Extruded Silicone

Temperature: -40°F to +450°F
-40°C to +232°C

Change in length at working pressure is +2% to -4%.

Applications:

- Transfer lines for nearly all chemicals
- Coolant Lines
- Compressed Air/Gases
- Adhesive dispensing

Special Features:

- Silicone jacket protects stainless steel wire reinforcement against wear and fraying even at temperatures up to 450F.
- Silicone jacket provides clean smooth cover and prevents contaminants from accumulating in braided reinforcement.
- Steam Cleanable
- Other non-standard colors available, including white FDA compliant silicone.
- Cover must be skived prior to fitting attachment

(+) Non Standard. See page ii for information on non-standard products.

919U High Abrasion Resistance PTFE Hose Exceeds SAE 100R14A Performance



Part Number	Hose I. D.		Max. Hose O. D.		Tube Wall	Max. Working Pressure		Min. Bend Radius		Vacuum Rating	Weight		Crimp Fitting		80C Crimp Die
#															
hose	inch	mm	inch	mm	inch	wpsi	MPa	inch	mm	inch/Hg.	lbs/ft	kg/m	series	pg	crimp die
919U-4	3/16	5	3/8	10	.030	3000	21	2.0	51	28	.084	12.5	91N	150-164	T04N
919U-6	5/16	8	1/2	13	.030	2500	17	4.0	102	28	.132	13.2	91N	150-164	T06N
919U-8	13/32	10	5/8	16	.030	2000	14	5.0	127	28	.15	15.0	91N	150-164	T08N
919U-12	5/8	16	27/32	21	.030	1200	8	7.5	191	12	.221	22.1	91N	150-164	T12N
919U-16	7/8	22	1-1/16	27	.035	1000	7	9.0	229	14	.314	31.4	91N	150-164	T16N

Min. Burst Pressure is 4x Max. Working Pressure

Tube: Natural FDA Compliant PTFE
Reinforcement: 304 Stainless Steel
Cover: Black Abrasion Resistant Urethane
Temperature: -40°F to +275°F
 -40°C to +135°C

Change in length at working pressure is +2% to -4%.

Applications:

- Transfer lines for nearly all chemicals
- Coolant Lines
- Compressed Air/Gases
- Adhesive dispensing

Special Features:

- Urethane jacket protects stainless steel wire reinforcement against wear and fraying.
- Cover must be skived prior to fitting attachment

929 Heavy Wall PTFE Hose Exceeds SAE 100R14A Performance



Part Number	Hose I. D.		Max. Hose O. D.		Tube Wall	Max. Working Pressure		Min. Bend Radius		Vacuum Rating	Weight		Crimp Fitting		80C Crimp Die
	#	inch	mm	inch		mm	wpsi	MPa	inch		mm	inch/Hg.	lbs/ft	kg/m	
929-4	3/16	5	5/16	8	.040	3000	21	1.5	38	28	.8	11.9	91N	150-164	T04N
929-6	5/16	8	7/16	11	.040	2500	17	3.5	89	28	.121	18.0	91N	150-164	T06N
929-8	13/32	10	9/16	14	.042	2000	14	4.5	114	28	.157	23.3	91N	150-164	T08N
929-12 (+)	5/8	16	3/4	19	.048	1200	8	6.5	165	12	.186	27.7	91N	150-164	T12N

Min. Burst Pressure is 4x Max. Working Pressure

Tube: Natural FDA Compliant PTFE
Reinforcement: 304 Stainless Steel
Temperature: -100°F to +450°F
 -73°C to +232°C

Change in length at working pressure is +2% to -4%.

Applications:

- Instrumentation Lines
- Sampling/Analyzing Lines
- 919 applications requiring tight routing

*Use hose type 929B with static-dissipative core tube when conveying non-conducting fluids such as oils, paints, fuels, steam, etc.

Special Features:

- Tighter bend radius
- Better kink resistance
- Enhanced resistance to gas permeation

929B Heavy Wall PTFE Hose with Static-Dissipative Tube Exceeds SAE 100R14B Performance



Part Number	Hose I. D.		Max. Hose O. D.		Tube Wall	Max. Working Pressure		Min. Bend Radius		Vacuum Rating	Weight		Crimp Fitting		80C Crimp Die
	#	inch	mm	inch		mm	wpsi	MPa	inch		mm	inch/Hg.	lbs/ft	kg/m	
929B-4	3/16	5	5/16	8	.040	3000	21	1.5	38	28	.8	11.9	91N	150-164	T04N
929B-6	5/16	8	7/16	11	.040	2500	17	3.5	89	28	.121	18.0	91N	150-164	T06N
929B-8	13/32	10	9/16	14	.042	2000	14	4.5	114	28	.157	23.3	91N	150-164	T08N
929B-12	5/8	16	3/4	19	.048	1200	8	6.5	165	12	.186	27.7	91N	150-164	T12N
929B-16	7/8	22	1-1/8	29	.048	1250	9	7.4	188	14	.488	72.6	91N	150-164	T16H

Min. Burst Pressure is 4x Max. Working Pressure

Tube: Black Static-Dissipative PTFE
Reinforcement: 304 Stainless Steel
Temperature: -100°F to +450°F
 -73°C to +232°C

Change in length at working pressure is +2% to -4%.

Applications:

- 919B applications requiring tight routing or enhanced permeation resistance

Special Features:

- Tighter bend radius
- Better kink resistance
- Enhanced resistance to gas permeation

929BJ Silicone Jacketed PTFE Hose with Static-Dissipative Tube Exceeds SAE 100R14B Performance

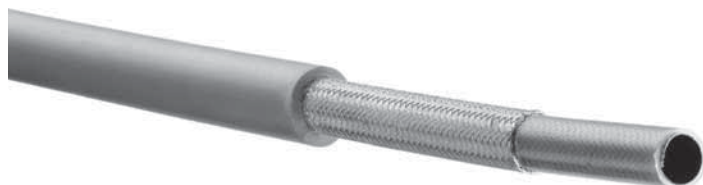

Part Number	Hose I. D.		Max. Hose O. D.		Tube Wall	Max. Working Pressure		Min. Bend Radius		Vacuum Rating	Weight		Crimp Fitting		80C Crimp Die
	#	inch	mm	inch		mm	wpsi	MPa	inch		mm	inch/Hg.	lbs/ft	kg/m	
929BJ-4	3/16	5	0.58	15	.040	3000	21	2.0	51	28	.17	25.3	91N	150-164	T04J
929BJ-5 (+)	1/4	6.3	0.63	16	.040	2500	17	2.0	51	28	.194	28.9	91N	150-164	T05J
929BJ-6	5/16	8	0.69	18	.040	2500	17	4.0	102	28	.232	34.5	91N	150-164	T06J
929BJ-8	13/32	10	0.79	20	.042	2000	14	4.6	117	28	.288	42.9	91N	150-164	T08J
929BJ-12	5/8	16	1.04	26	.042	1200	8	6.5	165	12	.403	60.0	91N	150-164	T12J
929BJ-16	7/8	22	1.36	35	.042	1250	9	7.4	188	14	.782	116.4	91N	150-164	T16HJ

Min. Burst Pressure is 4x Max. Working Pressure

Tube: Black Static-Dissipative PTFE

Reinforcement: 304 Stainless Steel

Cover: Brown Silicone Jacket

Temperature: -65°F to +450°F
-54°C to +232°C

Change in length at working pressure is +2% to -4%.

Applications:

- Vacuum lines for high temperature autoclaves
- Tough smooth bore hose applications requiring any or all of these special features.

Special Features:

- Silicone jacket protects stainless steel wire reinforcement against wear and fraying even at temperatures up to 450F.
- Silicone jacket provides clean smooth cover and prevents contaminants from accumulating in braided reinforcement.
- Steam Cleanable
- Tighter bend radius
- Better kink resistance
- Enhanced resistance to gas permeation
- Cover must be skived prior to fitting attachment

(+) Non Standard. See page ii for information on non-standard products.

939 Convoluted PTFE Hose



Part Number	Hose I. D.		Max. Hose O. D.		Max. Working Pressure		Min. Bend Radius		Vacuum Rating	Weight		Crimp Fitting		83C Crimp Die
	#	inch	mm	inch	mm	wpsi	MPa	inch		mm	inch/Hg.	lbs/ft	kg/m	
939-6	3/8	10	0.59	15	1500	10	2.25	57	28	.12	17.9	93	165-168	
939-8	1/2	12.5	0.79	20	1350	9	2.88	73	28	.211	31.4	93N	165-168	T08
939-10	5/8	16	0.88	22	1000	7	3.00	76	28	.24	35.7	93N	165-168	T10
939-12	3/4	19	1.09	28	1100	8	3.75	95	28	.316	47.0	93N	165-168	T12
939-16	1	25	1.33	34	1000	7	5.00	127	28	.451	67.1	93N	165-168	T16
939-20	1-1/4	31.5	1.75	44	1000	7	6.25	159	20*	.697	103.7	93N	165-168	T20
939-24	1-1/2	38	2.05	52	750	5	7.50	191	12*	.795	118.3	93N	165-168	T24
939-32	2	51	2.56	57	250	2	10.00	254	5*	1.01	150.3	93N	165-168	T32

Min. Burst Pressure is 4x Max. Working Pressure

Tube: Natural FDA Compliant PTFE

Reinforcement: 304 Stainless Steel

Temperature: -100°F to +450°F
-73°C to +232°C

Not recommended for steam-cold water cycling applications.

Applications:

- Transfer lines for nearly all chemicals
 - Compressed Air/Gases
- *Use hose type 939B with static-dissipative core tube when conveying non-conducting fluids such as oils, paints, fuels, steam, etc.

Special Features:

- Better flexibility
- Exceptional kink resistance

939B Convoluted PTFE Hose



Part Number	Hose I. D.		Max. Hose O. D.		Max. Working Pressure		Min. Bend Radius		Vacuum Rating	Weight		Crimp Fitting		83C Crimp Die
	#	inch	mm	inch	mm	wpsi	MPa	inch		mm	inch/Hg.	lbs/ft	kg/m	
939B-6	3/8	10	0.59	15	1500	10	2.25	57	28	.12	17.9	93	165-168	
939B-8	1/2	12.5	0.79	20	1350	9	2.88	73	28	.211	31.4	93N	165-168	T08
939B-10	5/8	16	0.88	22	1000	7	3.00	76	28	.24	35.7	93N	165-168	T10
939B-12	3/4	19	1.09	28	1100	8	3.75	95	28	.316	47.0	93N	165-168	T12
939B-16	1	25	1.33	34	1000	7	5.00	127	28	.451	67.1	93N	165-168	T16
939B-20	1-1/4	31.5	1.75	44	1000	7	6.25	159	20*	.697	103.7	93N	165-168	T20
939B-24	1-1/2	38	2.05	52	750	5	7.50	191	12*	.795	118.3	93N	165-168	T24
939B-32	2	51	2.56	57	250	2	10.00	254	5*	1.01	150.3	93N	165-168	T32

Min. Burst Pressure is 4x Max. Working Pressure

Tube: Black Static-Dissipative PTFE

Reinforcement: 304 Stainless Steel

Temperature: -100°F to +450°F
-73°C to +232°C

Not recommended for steam-cold water cycling applications.

Applications:

- Transfer lines for nearly all chemicals
- Hot oils
- Compressed Air/Gases

Special Features:

- Better flexibility
- Exceptional kink resistance

Note: A non-standard version of this hose is available with blue polyester braid instead of stainless steel reinforcement. Contact Parflex for performance specifications and availability.

943B - 3000 PSI W.P., High Temperature Hydraulic Hose Meets or exceeds 100R17 and 100R7 Performance



Part Number	Hose I. D.		Max. Hose O. D.		Tube Wall	Max. Working Pressure		Min. Bend Radius		Vacuum Rating	Weight		Crimp Fitting	
	#	inch	mm	inch		mm	wpsi	MPa	inch		mm	lbs./ft.	kg/m	series
943B-6	5/16	8	0.49	12	.040	3000	20.68	2.50	64	28	.175	26.0	94	169
943B-8	13/32	10	0.62	16	.045	3000	20.68	2.88	73	28	.235	35.0	94	169
943B-10	1/2	12.5	0.73	19	.051	3000	20.68	3.25	83	28	.264	39.3	94	169
943B-12	5/8	16	0.99	25	.051	3000	20.68	4.00	102	28	.66	98.2	94	169
943B-16	29/32	23	1.25	32	.051	3000	20.68	5.00	127	28	1.02	151.8	94	169

Min. Burst Pressure is 4x Max. Working Pressure

Tube: Black Static-Dissipative PTFE

Reinforcement: 304 Stainless Steel

Temperature: -65°F to +400°F
-54°C to +204°C

Change in length at working pressure is +2% to -2%

Not recommended for steam-cold water cycling applications.

Applications:

- High temperature hydraulic hose
- Transfer lines for nearly all chemicals
- Compressed Air/Gases
- Factory Crimp only

950B - 4000 PSI W.P., High Temperature Hydraulic Hose



Part Number	Hose I. D.		Max Hose O. D.		Tube Wall	Max. Working Pressure		Min. Bend Radius		Vacuum Rating	Weight		Crimp Fitting	
	#	inch	mm	inch		mm	wpsi	MPa	inch		mm	lbs./ft.	kg/m	series
950B-4	15/64	6	0.50	10	.050	4000	28	3.00	38	28	.196	29.2	95	169
950B-6	5/16	8	0.62	16	.050	4000	28	5.00	127	28	.24	35.7	95	169
950B-8	7/16	11	0.75	19	.050	4000	28	5.75	146	28	.454	67.6	95	169
950B-12	5/8	16	1.08	27	.060	4000	28	7.75	197	28	.96	142.9	95	169
950B-16	29/32	23	1.36	35	.060	4000	28	9.63	245	14	1.297	193.0	95	169

Min. Burst Pressure is 4x Max. Working Pressure

Tube: Black Static-Dissipative PTFE











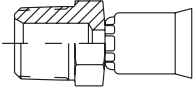
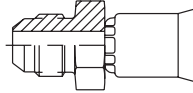
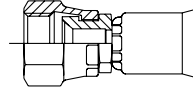

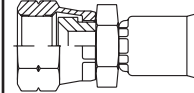
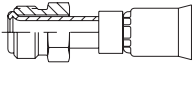
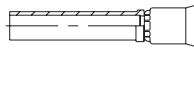
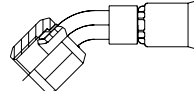
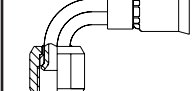
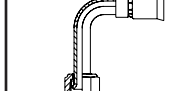
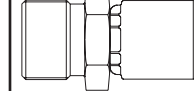
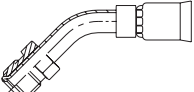
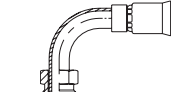
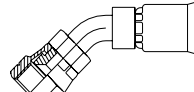
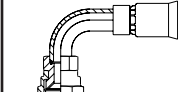
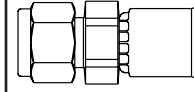
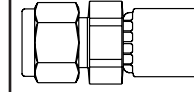
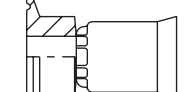
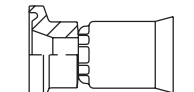
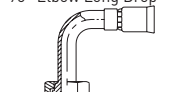
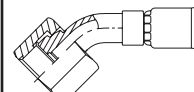
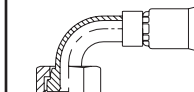
Reinforcement: Double High Density Braids of 304 Stainless Steel

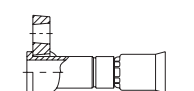
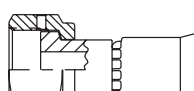
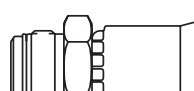
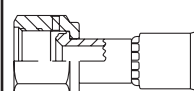
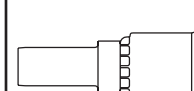
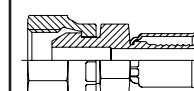
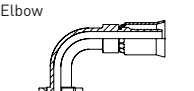

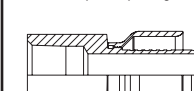

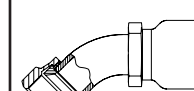
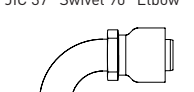
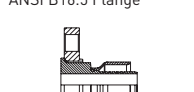
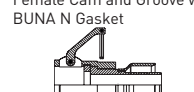



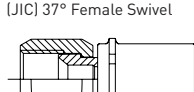

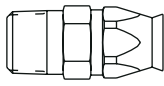
Temperature: -65°F to +400°F
-54°C to +204°C

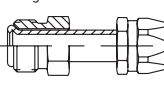
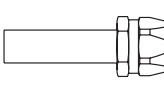
Change in length at working pressure is +2% to -2%

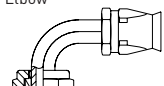
Applications:

- High temperature hydraulic hose
- Transfer lines for nearly all chemicals
- Compressed Air/Gases
- Factory Crimp only

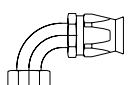
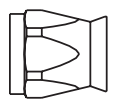
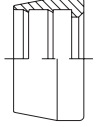
PTFE Permanent Hose Fittings						
91N Series Hose Fittings	101 Male Taper Pipe Rigid  91N pg. 150	103 Male (JIC) 37°  91N pg. 150	106 SAE (JIC) 37° Swivel  91N, 91NRD pg. 151	107 Female Pipe Swivel  91N pg. 152	108 SAE 45° Swivel  91N pg. 153	
	128 Male Inverted Swivel-Straight  91N pg. 153	134 Straight Tube  91N pg. 154	137 JIC 37° Swivel 45° Elbow  91N pg. 154	139 JIC 37° Swivel 90° Elbow  91N pg. 155	141 JIC 37° Swivel 90° Long Elbow  91N pg. 155	161 Compression Air Brake  91N pg. 156
	167 Male Inverted Swivel 45° Elbow  91N pg. 156	169 Male Inverted Swivel 90° Elbow  91N pg. 157	177 SAE 45° Swivel 45° Elbow  91N pg. 157	179 SAE 45° Swivel 90° Elbow  91N pg. 158	1A1 A-LOK® Compression  91N pg. 158	1P6 CPI® Compression (With Nut and Ferrule)  91N pg. 159
	1FN Sanitary Flange  91N pg. 159	1FV Mini Sanitary Flange  91N pg. 159	1J1 Female Seal-Lok™ Swivel 90° Elbow Long Drop  91N pg. 160	1J7 Seal-Lok™ Swivel 45° Elbow  91N pg. 161	1J9 Seal-Lok™ Swivel 90° Elbow  91N pg. 161	1JC Seal-Lok™ Straight  91N pg. 162
	1LF Laundry Flange Fitting  91N pg. 162	1Q1 Ultra Seal  91N pg. 162	1HV Male VacuSeal  91N pg. 163	1VH Female VacuSeal  91N pg. 163	1TU Universal Rube Stub Fitting  91N pg. 163	192 Female BSP Swivel  91N pg. 164
	1B2 Female BSP Swivel 90° Elbow  91N pg. 164	93N Series Hose Fittings	101 Male Taper Pipe Rigid  93N pg. 165	102 Female Taper Pipe Rigid  93N pg. 165	106 (JIC) 37° Female Swivel  93N pg. 165	137 JIC 37° Swivel 45° Elbow  93N pg. 166
	139 JIC 37° Swivel 90° Elbow  93N pg. 166	14K ANSI B16.5 Flange  93N pg. 167	1FC Female Cam and Groove with BUNA N Gasket  93N pg. 167	1MC Male Cam and Groove  93N pg. 167	1JC Seal-Lok™ Straight  93N pg. 168	1J7 Seal-Lok™ 45° Elbow  93N pg. 168
	1J9 Seal-Lok™ 90° Elbow  93N pg. 168	94, 95 Series Hose Fittings	106 (JIC) 37° Female Swivel  94, 95 pg. 169			

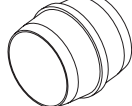
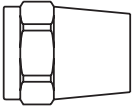
PTFE Field Attachable Hose Fittings						
 <p>90 Series Hose Fittings</p>	<p>201 Male Taper Pipe Rigid</p>  <p>90 pg. 142</p>	<p>206 SAE (JIC) 37° Swivel</p>  <p>90 pg. 142</p>	<p>208 SAE 45° Swivel</p>  <p>90 pg. 143</p>	<p>228 SAE Male Inverted Swivel-Straight</p>  <p>90 pg. 143</p>	<p>234 Straight Tube</p>  <p>90 pg. 143</p>	
	<p>237 SAE (JIC) 37° Swivel 45° Elbow</p>  <p>90 pg. 144</p>	<p>239 SAE (JIC) 37° Swivel 90° Elbow</p>  <p>90 pg. 145</p>	<p>261 SAE Compression Air Brake</p>  <p>90 pg. 145</p>	<p>267 SAE Male Inverted Swivel 45° Elbow</p>  <p>90 pg. 146</p>	<p>269 SAE Male Inverted Swivel 90° Elbow</p>  <p>90 pg. 147</p>	<p>277 SAE 45° Swivel 45° Elbow</p>  <p>90 pg. 147</p>
	<p>279 SAE 45° Swivel 90° Elbow</p>  <p>90 pg. 148</p>	<p>200 Replacement Socket for Field Attachable Fittings</p>  <p>90 pg. 149</p>	<p>0 Replacement Ferrule for 90 Series Field Attachable Fittings</p>  <p>90 pg. 149</p>	 <p>HAB Series Hose Fittings</p>	<p>60 HAB SAE Compression Airbrake Sleeve</p>  <p>HAB pg. 149</p>	<p>61 HAB SAE Compression Airbrake Nut</p>  <p>HAB pg. 149</p>

Note: Brass or stainless steel fittings are recommended for use with water-based fluids to avoid potential corrosion.

20190 Male Taper Pipe Rigid

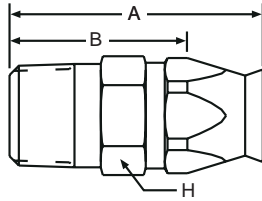

90 Series Field Attachable

*Part Number	B	C	NPTF Thread Size	Hose Size	A		Cutoff Allow. B		H Hex
#									
Hose Fitting				inch	inch	mm	inch	mm	inch
20190-2-4	+		1/8-27	-4	1.33	34	7/8	22	9/16
20190-4-4	+	+	1/4-18	-4	1.58	40	1-1/16	27	9/16
20190-4-5	+	+	1/4-18	-5	1.66	42	1-1/8	29	5/8
20190-4-6	+	+	1/4-18	-6	1.66	42	1-1/8	29	11/16
20190-6-6	+	+	3/8-18	-6	1.66	42	1-1/8	29	11/16
20190-6-8	+	+	3/8-18	-8	1.77	45	1-3/16	30	7/8
20190-8-8	+	+	1/2-14	-8	1.97	50	1-7/16	37	7/8
20190-8-10	+	+	1/2-14	-10	2.13	54	1-7/16	37	1
20190-12-12	+	+	3/4-14	-12	2.26	57	1-9/16	40	1-1/8
20190-12-16	+	+	3/4-14	-16	2.29	58	1-5/8	41	1-3/8
20190-16-16	+	+	1-11-1/2	-16	2.46	62	1-7/8	48	1-3/8
20190-20-20	+	+	1-1/4-11-1/2	-20	2.69	68	2-1/16	52	2

* Brass nipple and ferrule, steel socket.
 B - Brass nipple, brass shell.
 C - All components 303 stainless steel.

20690 SAE (JIC) 37° Swivel

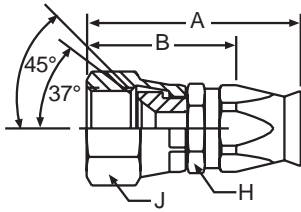

90 Series Field Attachable

*Part Number	B	C	NPTF Thread Size	Hose Size	A		Cutoff Allow. B		H Hex	J Hex
#										
Hose Fitting				inch	inch	mm	inch	mm	inch	
20690-4-4 ~	+		7/16-20	-4	1.58	40	1-1/8	29	9/16	9/16
20690-5-5 ~	+		1/2-20	-5	1.66	42	1-1/8	29	5/8	5/8
20690-6-6	+		9/16-18	-6	1.74	44	1-1/4	32	11/16	11/16
20690-8-6 ~	+	+	3/4-16	-6	1.85	47	1-5/16	33	7/8	7/8
20690-8-8 ~	+		3/4-16	-8	1.98	50	1-3/8	35	7/8	7/8
20690-8-10 ~	+	+	3/4-16	-10	2.07	53	1-7/16	37	1	7/8
20690-10-10 ~	+		7/8-14	-10	2.22	56	1-9/16	40	1	1
20690-12-12	+		1-1/16-12	-12	2.33	59	1-11/16	43	1-1/4	1-1/4
20690-16-16	+		1-5/16-12	-16	2.52	64	1-15/16	49	1-3/8	1-1/2
20690-20-20	+		1-5/8-12	-20	2.63	67	2-5/16	59	2	2

* Brass nipple and ferrule, steel nut and socket.
 ~ These fittings contain a dual seat that accepts both the JIC (37 deg.) and SAE (45 deg.) male configurations. The size -6 and -12 SAE (45 deg.) swivel fittings are shown under part number 20890.
 B - Brass nipple, brass nut, shell.

[+] Non Standard. See page ii for information on non-standard products.



20890 SAE 45° Swivel

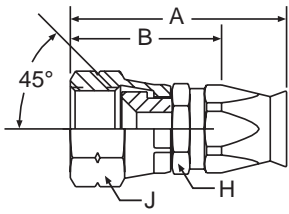

90 Series Field Attachable

*Part Number	B	C	NPTF Thread Size	Hose Size	Tube Size	A		Cutoff Allow. B		H Hex	J Hex
#											
Hose Fitting				inch	inch	inch	mm	inch	mm	inch	inch
20890-6-6	+	+	5/8-18	-6	3/8	1.77	45	1-5/16	33	11/16	3/4
20890-12-12	+	+	1-1/16-14	-12	1-11/16	2.34	59	1-11/16	43	1-1/4	1-1/4

* Brass nipple and ferrule, steel nut and socket.
 B - Brass nipple, brass nut, shell.
 C - All components 303 stainless steel.

22890 SAE Male Inverted Swivel-Straight

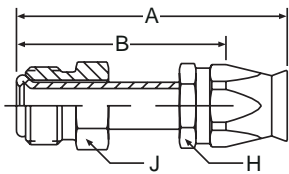

90 Series Field Attachable

*Part Number	B	C	NPTF Thread Size	Hose Size	Tube Size	A		Cutoff Allow. B		H Hex	J Hex
#											
Hose Fitting				inch	inch	inch	mm	inch	mm	inch	inch
22890-4-4	+	+	7/16-24	-4	1/4	2.15	55	1-5/8	41	9/16	7/16
22890-5-5	+	+	1/2-20	-5	5/16	2.21	56	1-11/16	43	5/8	1/2
22890-5-6	+	+	1/2-20	-6	5/16	2.20	56	1-11/16	43	11/16	1/2
22890-6-6	+	+	5/8-18	-6	3/8	2.22	56	1-3/4	44	11/16	5/8
22890-8-8	+	+	3/4-18	-8	1/2	2.34	59	1-3/4	44	7/8	3/4
22890-10-10	+	+	7/8-18	-10	5/8	2.77	70	2-1/8	54	15/16	7/8
22890-12-12	+	+	1-1/16-16	-12	3/4	3.01	76	2-3/8	60	1-1/8	1-1/16

* Brass ferrule, steel tube, nut and socket.
 B - Brass nipple, brass shell.
 C - All components 303 stainless steel.

23490 Straight Tube

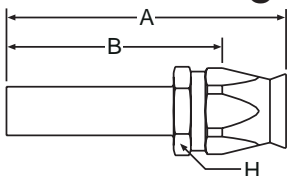

90 Series Field Attachable

*Part Number	B	C	Hose Size	Tube Size	A		Cutoff Allow. B		H Hex
#									
Hose Fitting			inch	inch	inch	mm	inch	mm	inch
23490-8-8	+	+	-8	1/2	3.06	78	2-7/16	62	13/16
23490-8-10	+	+	-10	1/2	3.18	81	2-1/2	64	1
23490-10-8 (+)	+	+	-8	5/8	3.26	83	2-11/16	69	13/16
23490-10-10	+	+	-10	5/8	3.32	84	2-5/8	67	1
23490-12-12	+	+	-12	3/4	3.74	95	3-1/16	78	1-1/8

* Brass nipple and ferrule, steel socket.
 B - Brass nipple, brass shell.
 C - All components 303 stainless steel.
 26T90 fitting includes 23490 with the 60HAB sleeve and 61HAB nut.

(+) Non Standard. See page ii for information on non-standard products.

23790 SAE (JIC) 37° Swivel 45° Elbow

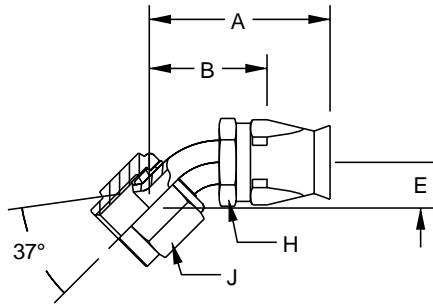

90 Series Field Attachable

*Part Number	B	C	NPTF Thread Size	Hose Size	Tube Size	A		Cutoff Allow. B		E		H Hex	J Hex
						inch	mm	inch	mm	inch	mm	inch	inch
#													
Hose Fitting				inch	inch	inch	mm	inch	mm	inch	mm	inch	inch
23790-4-4	+	+	7/16-20	-4	1/4	1.79	45	1-3/8	35	0.33	8	9/16	9/16
23790-5-5	+	+	1/2-20	-5	5/16	1.86	47	1-1/8	29	0.36	9	5/8	5/8
23790-6-6	+	+	9/16-18	-6	3/8	1.96	50	1-7/16	37	0.39	10	11/16	11/16
23790-8-6	+	+	3/4-16	-6	1/2	2.11	54	1-11/16	43	0.55	14	11/16	7/8
23790-8-8	+	+	3/4-16	-8	1/2	2.32	59	1-3/4	44	0.55	14	13/16	7/8
23790-10-10	+	+	7/8-14	-10	5/8	2.45	62	1-7/8	48	0.63	16	15/16	1
23790-12-12	+	+	1-1/16-12	-12	3/4	3.04	77	2-7/16	62	0.78	20	1-1/8	1-1/4
23790-16-16	+	+	1-5/16-12	-16	1	3.28	83	2-11/16	68	0.90	23	1-3/8	1-1/2
23790-20-20	+	+	1-5/8-12	-20	1-1/4	3.70	94	3-1/16	78	1.10	28	1-3/4	2

* Brass ferrule, steel tube, nut and socket.

B - Brass nipple, brass nut, shell.

C - All components 303 stainless steel.

[+] Non Standard. See page ii for information on non-standard products.

23990 SAE (JIC) 37° Swivel 90° Elbow

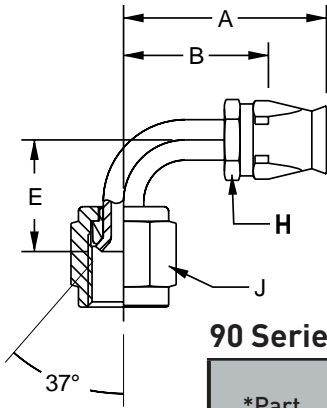

90 Series Field Attachable

*Part Number	C	Thread Size	Hose Size	Tube Size	A		Cutoff Allow. B		E		H Hex	J Hex
					inch	mm	inch	mm	inch	mm	inch	inch
#												
Hose Fitting			inch	inch	inch	mm	inch	mm	inch	mm	inch	inch
23990-4-4	+	7/16-20	-4	1/4	1.67	41	1-1/4	32	0.68	17	9/16	9/16
23990-5-5	+	1/2-20	-5	5/16	1.75	44	1-1/4	32	0.77	20	5/8	5/8
23990-6-6	+	9/16-18	-6	3/8	1.86	47	1-3/8	35	0.85	22	11/16	11/16
23990-8-6	+	3/4-16	-6	1/2	1.95	50	1-7/16	37	1.09	28	11/16	7/8
23990-8-8	+	3/4-16	-8	1/2	2.15	55	1-1/2	38	1.09	28	13/16	7/8
23990-10-10	+	7/8-14	-10	5/8	2.38	60	1-3/4	44	1.23	31	15/16	1
23990-12-12	+	1-1/16-12	-12	3/4	2.95	75	2-5/16	59	1.82	46	1-1/8	1-1/4
23990-16-16	+	1-5/16-12	-16	1	3.13	80	2-1/2	64	2.14	54	1-3/8	1-1/2
23990-20-20	+	1-5/8-12	-20	1-1/4	3.54	90	1-7/8	73	2.57	65	2	1-3/4

* Brass ferrule, steel tube, nut and socket.
C - All components 303 stainless steel.

26190 SAE Compression Air Brake

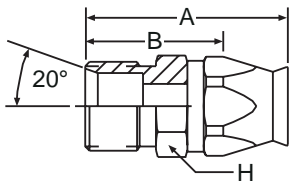

90 Series Field Attachable

*Part Number	B	C	Thread Size	Hose Size	Tube Size	A		Cutoff Allow. B		H Hex
#										
Hose Fitting				inch	inch	inch	mm	inch	mm	inch
26190-8-8	+	+	11/16-20	-8	1/2	1.69	43	1-1/16	27	13/16
26190-8-10	+	+	11/16-20	-10	1/2	1.86	47	1-3/16	30	1
26190-10-10	+	+	13/16-18	-10	5/8	1.92	49	1-15/16	49	1
26190-12-10 (+)	+	+	1-18	-10	3/4	1.31	33	1-5/16	33	1
26190-12-12	+	+	1-18	-12	3/4	2.09	53	1-7/16	37	1-1/8

* Brass nipple and ferrule, steel socket.
B - Brass nipple, brass shell.
C - All components 303 stainless steel.

(+) Non Standard. See page ii for information on non-standard products.

26790 SAE Male Inverted Swivel 45° Elbow

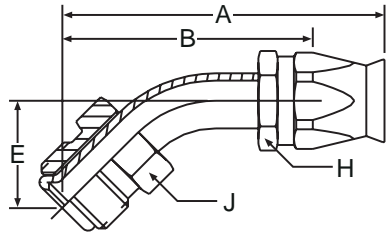

90 Series Field Attachable

*Part Number	B	C	Thread Size	Hose Size	Tube Size	A		Cutoff Allow. B		E		H Hex	J Hex
						inch	mm	inch	mm	inch	mm	inch	inch
#													
Hose Fitting				inch	inch	inch	mm	inch	mm	inch	mm	inch	inch
26790-4-4	+	+	7/16-24	-4	1/4	2.11	54	1-11/16	43	0.63	16	9/16	7/16
26790-5-5	+	+	1/2-20	-5	5/16	2.51	64	2	51	0.94	24	5/8	1/2
26790-5-6	+	+	1/2-20	-6	5/16	2.55	65	2-1/16	52	0.94	24	11/16	1/2
26790-6-6	+	+	5/8-18	-6	3/8	2.61	66	2-1/8	54	0.94	24	11/16	5/8
26790-8-8	+	+	3/4-18	-8	1/2	2.68	68	2-1/16	52	0.94	24	7/8	3/4
26790-8-10 (+)	+	+	3/4-18	-10	1/2	2.77	70	2-1/8	54	0.94	24	15/16	3/4
26790-10-10 (+)	+	+	7/8-18	-10	5/8	2.92	74	2-5/16	59	1.02	26	15/16	7/8
26790-12-12 (+)	+	+	1-1/16-16	-12	3/4	3.14	80	2-1/2	64	1.02	26	1-1/8	1-1/16

* Brass ferrule, steel tube, nut and socket.
 B - Brass nipple, brass shell.
 C - All components 303 stainless steel.

(+) Non Standard. See page ii for information on non-standard products.

26990 SAE Male Inverted Swivel 90° Elbow

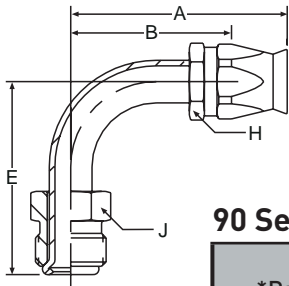

90 Series Field Attachable

*Part Number	C	Thread Size		Tube Size	A		Cutoff Allow. B		E		H Hex	J Hex
					inch	mm	inch	mm	inch	mm	inch	inch
#												
Hose Fitting			inch	inch	inch	mm	inch	mm	inch	mm	inch	inch
26990-4-4	+	7/16-24	-4	1/4	1.79	45	1-5/16	33	1.19	30	9/16	7/16
26990-5-5	+	1/2-20	-5	5/16	2.01	51	1-1/2	38	1.65	42	5/8	1/2
26990-5-6	+	1/2-20	-6	5/16	2.05	52	1-9/16	40	1.65	42	11/16	1/2
26990-6-6	+	5/8-18	-6	3/8	2.03	52	1-1/2	38	1.70	43	11/16	5/8
26990-8-8	+	3/4-18	-8	1/2	2.30	58	1-11/16	43	1.78	45	13/16	3/4
26990-8-10 (+)	+	3/4-18	-10	1/2	2.39	61	1-3/4	44	1.78	45	15/16	3/4
26990-10-10 (+)	+	7/8-18	-10	5/8	2.65	67	2	51	2.18	55	15/16	7/8
26990-12-12 (+)	+	1-1/16-16	-12	3/4	2.81	71	2-3/16	56	2.51	64	1-1/8	1-1/16

* Brass ferrule, steel tube, nut and socket.
C - All components 303 stainless steel.

27790 SAE 45° Swivel 45° Elbow

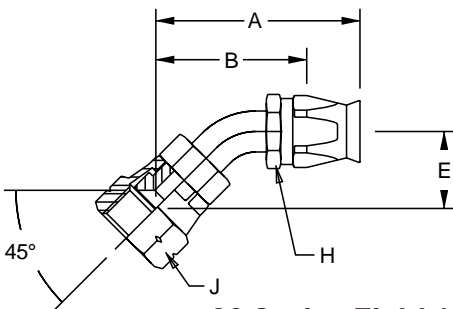

90 Series Field Attachable

*Part Number	C	Thread Size		Tube Size	A		Cutoff Allow. B		E		H Hex	J Hex
					inch	mm	inch	mm	inch	mm	inch	inch
#												
Hose Fitting			inch	inch	inch	mm	inch	mm	inch	mm	inch	inch
27790-6-6	+	5/8-18	-6	3/8	1.72	44	1-3/16	30	0.39	10	11/16	3/4
27790-12-12	+	1-1/16-14	-12	3/4	2.87	73	2-1/4	57	0.78	20	1-1/8	1-1/4

* Brass ferrule, steel tube, nut and socket.
C - All components 303 stainless steel.

(+) Non Standard. See page ii for information on non-standard products.



27990 SAE 45° Swivel 90° Elbow

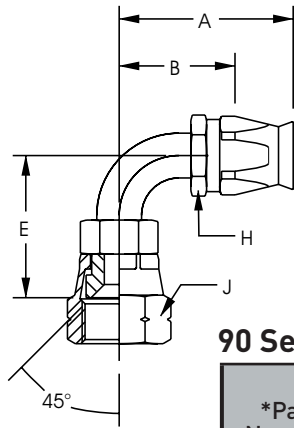

90 Series Field Attachable

*Part Number	C	Thread Size	Tube Size		A		Cutoff Allow. B		E		H Hex	J Hex
			inch	mm	inch	mm	inch	mm	inch	mm	inch	inch
#												
Hose Fitting			inch	inch	inch	mm	inch	mm	inch	mm	inch	inch
27990-4-4 (+)	+	7/16-20	-4	1/4	1.67	42	1-1/4	32	0.68	17	9/16	9/16
27990-5-5 (+)	+	1/2-20	-5	5/16	1.75	44	1-1/4	32	0.77	20	5/8	5/8
27990-6-6	+	5/8-18	-6	3/8	1.86	47	1-3/8	35	0.85	22	3/4	11/16
27990-8-8 (+)	+	3/4-16	-8	1/2	2.15	55	1-1/2	38	1.09	28	7/8	13/16
27990-12-12	+	1-1/16-14	-12	3/4	2.95	75	2-5/16	59	1.82	46	1-1/4	1-1/8

* Brass ferrule, steel tube, nut and socket.

B - Brass nipple, brass shell.

C - All components 303 stainless steel.

(+) Non Standard. See page ii for information on non-standard products.

20090 Replacement Socket for Field Attachable Fittings

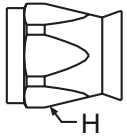

Steel Socket Part Number	Stainless Steel Socket Part Number	H Hex
#	#	
20090-4	20090-4C	9/16
20090-5	20090-5C	5/8
20090-6	20090-6C	11/16
20090-8	20090-8C	7/8
20090-10	20090-10C	1
20090-12	20090-12C	1-1/8
20090-16	20090-16C	1-3/8
20090-20	20090-20C	1-3/4

60 HAB SAE Compression Airbrake Sleeve

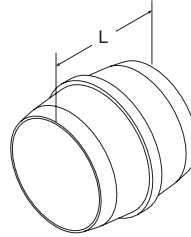

*Part Number	Tube Size	L
#		
60HAB-4	1/4	.250
60HAB-6	3/8	.313
60HAB-8	1/2	.375
60HAB-10	5/8	.438
60HAB-12	3/4	.500

*Brass
*To be used with "34" Fittings

090 Replacement Ferrule for 90 Series Field Attachable Fittings

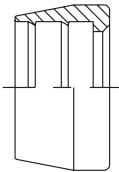

Brass Ferrule Part Number	Stainless Steel Ferrule Part Number	Hose Size
#	#	
090-4B	090-4C	-4
090-5B	090-5C	-5
090-6B	090-6C	-6
090-8B	090-8C	-8
090-10B	090-10C	-10
090-12B	090-12C	-12
090-16B	090-16C	-16
090-20B	090-20C	-20

61 HAB SAE Compression Airbrake Nut

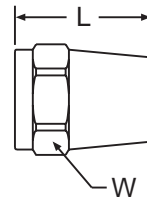

*Part Number	Thread Size	Tube Size	E		H Hex
#					
Hose Fitting		inch	inch	mm	inch
61HAB-4	7/16-24	1/4	0.75	19	9/16
61HAB-6	7/32-24	3/8	1.13	29	5/8
61HAB-8	11/16-20	1/2	1.25	32	13/16
61HAB-10	13/16-18	5/8	1.38	35	15/16
61HAB-12	1-18	3/4	1.56	40	1-1/8

*Brass
*To be used with "34" Fittings

(+) Non Standard. See page ii for information on non-standard products.

10191N Male Taper Pipe Rigid

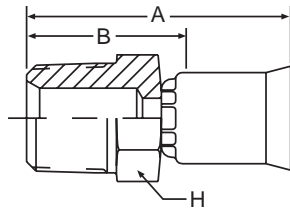

91N Series Permanent

*Part Number	B	C	NPTF Thread Size	A			Cutoff Allow. B		H Hex
#									
Hose Fitting				inch	inch	mm	inch	mm	inch
10191N-2-4			1/8-27	-4	1.27	32	3/4	19	7/16
10191N-4-4	+		1/4-18	-4	1.50	38	15/16	24	9/16
10191N-4-5	+		1/4-18	-5	1.55	39	15/16	24	9/16
10191N-4-6	+		1/4-18	-6	1.60	41	15/16	24	9/16
10191N-6-6	+		3/8-18	-6	1.65	58	1	25	11/16
10191N-6-8	+		3/8-18	-8	1.71	43	1	25	11/16
10191N-8-8	+		1/2-14	-8	1.94	49	1-1/4	32	7/8
10191N-8-10	+		1/2-14	-10	1.96	50	1-1/4	32	7/8
10191N-8-12 (+)	+	+	1/2-14	-12	2.42	61	1-1/4	32	7/8
10191N-12-12	+		3/4-14	-12	2.19	56	1-3/8	35	1-1/8
10191N-16-16	+		1-11-1/2	-16	2.46	62	1-1/2	38	1-3/8
10191-20-20			1-1/4-11-1/2	-20	3.05	77	2-1/16	52	1-3/4

* Brass nipple, steel shell.
 B - Brass nipple, brass shell.
 C - All components 303 stainless steel.

10391N Male (JIC) 37°

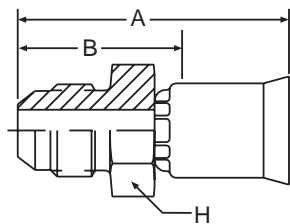

91N Series Permanent

*Part Number	B	C	NPTF Thread Size	A			Cutoff Allow. B		H Hex
#									
Hose Fitting				inch	inch	mm	inch	mm	inch
10391N-4-4 (+)	+	+	7/16-20	-4	1.37	35	13/16	21	1/2
10391N-5-5 (+)	+	+	1/2-20	-5	1.48	38	7/8	22	9/16
10391N-6-6 (+)	+	+	9/16-18	-6	1.64	42	1	25	11/16
10391N-8-8 (+)	+	+	3/4-16	-8	1.79	35	1-1/8	29	7/8
10391N-8-6 (+)	+	+	3/4-16	-6	1.73	44	1-1/16	27	7/8
10391N-10-10 (+)	+	+	7/8-14	-10	2.07	53	1-3/8	35	7/8
10391N-12-12 (+)	+	+	1-1/16-12	-12	2.10	53	1-5/16	33	1-1/8
10391N-16-16 (+)	+	+	1-5/16-12	-16	2.43	62	1-1/2	38	1-3/8

* Brass nipple, steel shell.
 B - Brass nipple, brass shell.
 C - All components 303 stainless steel.

(+) Non Standard. See page ii for information on non-standard products.

10691N SAE (JIC) 37° Swivel

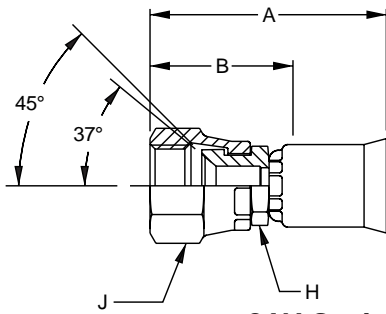

91N Series Permanent

*Part Number	S	B	C	Thread Size		Tube Size	A		Cutoff Allow. B		H Hex	J Hex
#												
Hose Fitting					inch	inch	inch	mm	inch	mm	inch	inch
10691N-4-4 ~				7/16-20	-4	1/4	1.43	36	7/8	22	3/8	9/16
10691N-5-5 ~		+		1/2-20	-5	5/16	1.56	40	15/16	24	7/16	5/8
10691N-6-6				9/16-18	-6	3/8	1.63	41	1	25	1/2	11/16
10691N-6-8	+	+	+	9/16-18	-8	1/2	1.69	43	1	25	9/16	11/16
10691N-8-8 ~		+		3/4-16	-8	1/2	1.89	48	1-3/16	30	11/16	7/8
10691N-8-10 ~	+	+		3/4-16	-10	5/8	1.86	58	1-1/8	29	3/4	7/8
10691N-10-10 ~		+		7/8-14	-10	5/8	2.03	52	1-5/16	33	13/16	1
10691N-12-12		+		1-1/16-12	-12	3/4	2.12	54	1-5/16	33	1	1-1/4
10691N-16-16		+		1-5/16-12	-16	1	2.45	62	1-9/16	40	1-1/4	1-1/2
10691-20-20	+	+		1-5/8-12	-20	1-1/4	2.98	76	1-13/16	46	1-11/16	2

* Brass nipple, steel nut, shell.

~ These fittings contain a dual seat that accepts both the JIC (37 deg.) and SAE (45 deg.) male configurations. The size -6 and -12 swivel fittings are shown under part number 10891N.

S - Steel nipple, steel nut, shell.

B - Brass nipple, brass nut, shell.

C - All components 303 stainless steel.

10691NRD

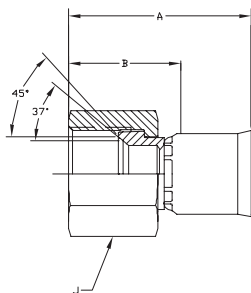

91N Series Permanent

*Part Number	B	C	Thread Size		Tube Size	A		Cutoff Allow. B		J Hex	
#											
Hose Fitting					inch	inch	inch	mm	inch	mm	inch
10691N-4-4-RD ~ (+)	+	+	7/16-20	-4	1/4	1.34	34	13/16	21	9/16	
10691N-5-5-RD ~ (+)	+	+	1/2-20	-5	5/16	1.51	38	7/8	22	5/8	
10691N-6-6-RD (+)	+	+	9/16-18	-6	3/8	1.60	41	15/16	24	11/16	
10691N-8-8-RD ~ (+)	+	+	3/4-16	-8	1/2	1.79	45	1-1/16	27	7/8	
10691N-10-10-RD ~	+	+	7/8-14	-10	5/8	1.91	49	1-3/16	30	1	
10691N-12-12-RD (+)	+	+	1-1/16-12	-12	3/4	2.09	58	1-5/16	33	1-1/4	
10691N-16-16-RD ~ (+)	+	+	1-5/16-12	-16	1	2.27	58	1-5/16	33	1-1/2	

* Brass nipple, steel nut, shell.

~ These fittings contain a dual seat that accepts both the JIC (37 deg.) and SAE (45 deg.) male configurations. The size -6 and -12 swivel fittings are shown under part number 10891N.

B - Brass nipple, brass nut, shell.

C - All components 303 stainless steel.

(+) Non Standard. See page ii for information on non-standard products.



10791N Female Pipe Swivel

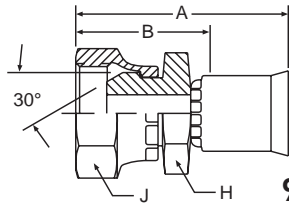

91N Series Permanent

*Part Number	B	C	Thread Size		Tube Size	A		Cutoff Allow. B		H Hex	J Hex
#											
Hose Fitting				inch	inch	inch	mm	inch	mm	inch	inch
10791N-4-4	+		1/4-18	-4	1/4	1.50	38	15/16	24.00	9/16	11/16
10791N-6-6	+		3/8-18	-6	3/8	1.67	42	1	25	5/8	7/8
10791N-8-8	+		1/2-14	-8	1/2	1.83	46	1-1/8	29	3/4	1
10791N-12-12	+		3/4-14	-12	3/4	2.09	53	1-5/16	33	1	1-1/4
10791N-16-16	+		1-11-1/2	-16	1	2.26	57	1-5/16	33	1-3/16	1-3/8

* Brass nipple , steel nut and shell.
 B – Brass nipple, brass nut, shell.
 C – All components are 300 series stainless steel.

PTFE Hose & Fittings

Thermoplastic Tubing

Coiled Air Hose, Fittings & Accessories

Truck (Fleet) Products

Tooling & Equipment

Hose Accessories

Technical & Design Information

Approvals & Guides

Alphanumeric Index

[+] Non Standard. See page ii for information on non-standard products.

10891N SAE 45° Swivel

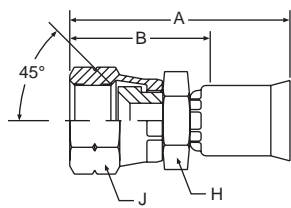

91N Series Permanent

*Part Number	S	C	Thread Size	Tube Size	A		Cutoff Allow. B		H Hex	J Hex
#										
Hose Fitting				inch	inch	inch	mm	inch	mm	inch
10891N-6-6	+	+	5/8-18	-6	3/8	1.69	43	1-1/16	27.00	5/8
10891N-12-12	+	+	1-1/16-14	-12	3/4	2.12	54	1-5/16	33	1

* Brass nipple, steel nut and shell.
 S – Steel nipple, nut and shell.
 C – All components are 300 series stainless steel.

12891N Male Inverted Swivel–Straight

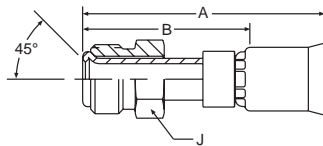

91N Series Permanent

*Part Number	B	C	Thread Size	Tube Size	A		Cutoff Allow. B		J Hex	
#										
Hose Fitting				inch	inch	inch	mm	inch	mm	inch
12891N-4-4	+	+	7/16-24	-4	1/4	2.09	53	1-1/2	38	7/16
12891N-5-5	+	+	1/2-20	-5	5/16	2.15	55	1-9/16	40	1/2
12891N-5-6	+	+	1/2-20	-6	3/8	2.23	57	1-9/16	40	1/2
12891N-6-6	+	+	5/8-18	-6	3/8	2.23	57	1-9/16	40	5/8
12891N-8-8	+	+	3/4-18	-8	1/2	2.31	59	1-5/8	41	3/4
12891N-10-10	+	+	7/8-18	-10	5/8	2.43	58	1-3/4	44	7/8
12891N-12-12	+	+	1-1/16-16	-12	3/4	2.50	64	1-11/16	43	1-1/16

* Steel nipple, tube, nut and shell.
 B – Brass nipple, brass shell.
 C – All components 303 stainless steel.

[+] Non Standard. See page ii for information on non-standard products.

13491N Straight Tube

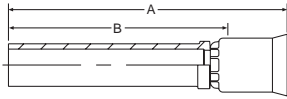

91N Series Permanent

*Part Number	B	C		Tube Size	A		Cutoff Allow. B	
#								
Hose Fitting			inch	inch	inch	mm	inch	mm
13491N-8-8	+	+	-8	1/2	2.80	71	2-1/8	54
13491N-8-10	+	+	-10	1/2	2.81	71	2-1/8	54
13491N-10-10	+	+	-10	5/8	2.96	75	2-1/4	58
13491N-12-12	+	+	-12	3/4	3.37	86	2-9/16	65

* Brass nipple, steel shell.

B - Brass nipple, brass nut, shell.

C - All components 303 stainless steel.

The 16T91N fitting includes 13491N with the 60HAB sleeve and 61HAB nut.

13791N JIC 37° Swivel 45° Elbow

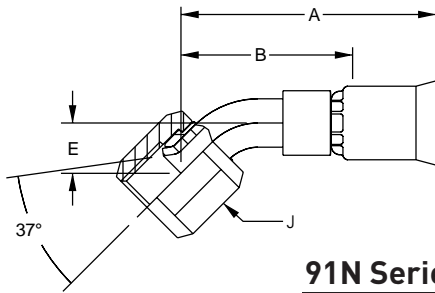

91N Series Permanent

*Part Number	C	Thread Size		Tube Size	A		Cutoff Allow. B		E	J Hex	
#											
Hose Fitting			inch	inch	inch	mm	inch	mm	inch	mm	
13791N-4-4		7/16-20	-4	1/4	1.74	44	1-3/16	30	0.33	8	9/16
13791N-5-5	+	1/2-20	-5	5/16	1.87	47	1-1/4	32	0.36	9	5/8
13791N-6-6		9/16-18	-6	3/8	1.94	49	1-5/16	33	0.39	10	11/16
13791N-8-8		3/4-16	-8	1/2	2.28	58	1-9/16	37	0.55	14	7/8
13791N-10-10		7/8-14	-10	5/8	2.42	61	1-11/16	43	0.64	43	1
13791N-12-12	+	1-1/16-12	-12	3/4	2.83	58	2-1/16	52	0.78	20	1-1/4
13791N-16-16	+	1-5/16-12	-16	1	3.18	81	2-1/4	57	0.89	23	1-1/2
13791-20-20	+	1-5/8-12	-20	1-1/4	3.67	93	2-9/16	65	1.10	28	2

* Steel tube, nipple, nut and shell.

B - Brass nipple, brass shell.

C - All components 303 stainless steel.

[+] Non Standard. See page ii for information on non-standard products.

13991N JIC 37° Swivel 90° Elbow

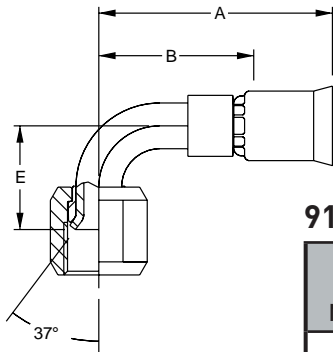

91N Series Permanent

*Part Number	C	Thread Size		Tube Size	A		Cutoff Allow. B		E		J Hex
#											
Hose Fitting			inch	inch	inch	mm	inch	mm	inch	mm	inch
13991N-4-4		7/16-20	-4	1/4	1.62	41	1-1/16	37	0.68	17	9/16
13991N-5-5	+	1/2-20	-5	5/16	1.71	43	1-1/8	29	0.77	20	5/8
13991N-6-6	+	9/16-18	-6	3/8	1.91	49	1-1/4	32	0.85	22	11/16
13991N-8-8		3/4-16	-8	1/2	2.03	52	1-5/16	33	1.09	28	7/8
13991N-10-10		7/8-14	-10	5/8	2.27	58	1-9/16	37	1.23	43	1
13991N-12-12	+	1-1/16-12	-12	3/4	2.75	58	1-15/16	49	1.82	46	1-1/2
13991N-16-16	+	1-5/16-12	-16	1	3.15	80	2-3/16	56	2.14	52	1-1/2
13991-20-20	+	1-5/8-12	-20	1-1/4	3.53	90	2-7/16	62	1.18	30	2

* Steel tube, nipple, nut and shell.
C - All components 303 stainless steel.

14191N JIC 37° Swivel 90° Long Elbow

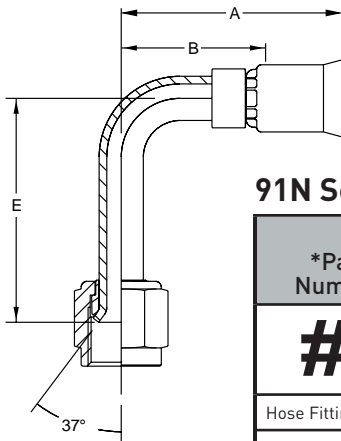

91N Series Permanent

*Part Number	C	Thread Size		Tube Size	A		Cutoff Allow. B		E		J Hex
#											
Hose Fitting			inch	inch	inch	mm	inch	mm	inch	mm	inch
14191N-4-4		7/16-20	-4	1/4	1.66	42	1-1/8	29	1.80	46	9/16
14191N-5-5	+	1/2-20	-5	5/16	1.72	44	1-1/8	29	1.77	45	5/8
14191N-6-6	+	9/16-18	-6	3/8	1.93	49	1-5/16	33	2.18	55	11/16
14191N-8-8	+	3/4-16	-8	1/2	2.11	54	1-3/8	35	2.43	62	7/8
14191N-10-10	+	7/8-14	-10	5/8	2.34	59	1-5/8	41	2.57	43	1
14191N-12-12	+	1-1/16-12	-12	3/4	2.63	58	1-7/8	48	3.73	95	1-1/4
14191N-16-16	+	1-5/16-12	-16	1	3.15	80	2-3/16	56	4.33	110	1-1/2
14191-20-20 (+)	+	1-5/8-12	-20	1-1/4	4.00	102	2-15/16	75	5.28	134	2

* Steel tube, nipple, nut and shell.
C - All components 303 stainless steel.

(+) Non Standard. See page ii for information on non-standard products.



16191N Compression Air Brake

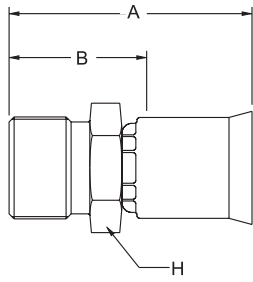

91N Series Permanent

*Part Number	B	C	Thread Size	Tube Size	A		Cutoff Allow. B		H Hex	
#										
Hose Fitting				inch	inch	inch	mm	inch	mm	inch
16191N-8-8	+	+	11/16-20	-8	1/2	1.61	41	15/16	24	3/4
16191N-8-10	+	+	11/16-20	-10	5/8	1.61	41	15/16	24	7/8
16191N-10-10	+	+	13/16-18	-10	5/8	1.82	46	1-1/8	29	15/16
16191N-12-12	+	+	1-18	-12	3/4	1.93	49	1-1/8	29	1-1/4

* Brass nipple, steel shell.
 B - Brass nipple, brass shell.
 C - All components 303 stainless steel.

16791N Male Inverted Swivel 45° Elbow

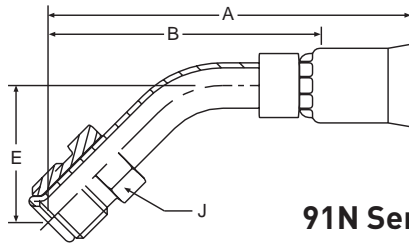

91N Series Permanent

*Part Number	C	Thread Size	Tube Size	A		Cutoff Allow. B		E		J Hex	
#											
Hose Fitting			inch	inch	inch	mm	inch	mm	inch	mm	inch
16791N-4-4	+	7/16-24	-4	1/4	2.05	52	1-1/2	38	0.63	16	7/16
16791N-5-5	+	1/2-20	-5	5/16	2.48	63	1-7/8	48	0.71	18	1/2
16791N-6-6	+	5/8-18	-6	3/8	2.60	66	1-15/16	49	0.96	24	5/8
16791N-8-8	+	3/4-18	-8	1/2	2.85	72	2-1/8	54	0.90	23	3/4
16791N-10-10	+	7/8-18	-10	5/8	3.30	84	2-5/8	67	1.02	43	7/8
16791N-12-12	+	1-1/16-16	-12	3/4	3.64	58	2-13/16	71	1.15	29	1-1/16

* Steel tube, nipple, nut and shell.
 B - Brass nipple, brass shell.
 C - All components 303 stainless steel.

[+] Non Standard. See page ii for information on non-standard products.

16991N Male Inverted Swivel 90° Elbow

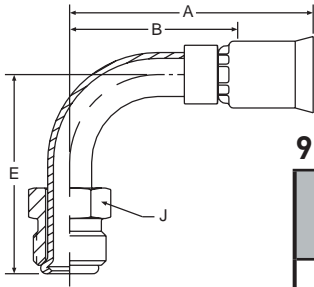

91N Series Permanent

*Part Number	C	Thread Size	Tube Size		A		Cutoff Allow. B		E		J Hex
			inch	mm	inch	mm	inch	mm	inch	mm	inch
#											
Hose Fitting			inch	inch	inch	mm	inch	mm	inch	mm	inch
16991N-4-4	+	7/16-24	-4	1/4	1.72	44	1-3/16	30	1.19	30	7/16
16991N-5-5	+	1/2-20	-5	5/16	1.98	50	1-3/8	35	1.65	42	1/2
16991N-5-6 (+)	+	1/2-20	-6	3/8	2.03	52	1-7/16	37	1.65	42	1/2
16991N-6-6	+	5/8-18	-6	3/8	2.08	53	1-7/16	37	1.70	43	5/8
16991N-8-8	+	3/4-18	-8	1/2	2.18	55	1-1/2	38	1.87	43	3/4
16991N-10-10	+	7/8-18	-10	5/8	3.02	58	2-5/16	59	2.18	55	7/8
16991N-12-12	+	1-1/16-16	-12	3/4	3.36	85	2-9/16	64	2.51	64	1-1/16

* Steel tube, nipple, nut and shell.
 C - All components 303 stainless steel.

17791N SAE 45° Swivel 45° Elbow

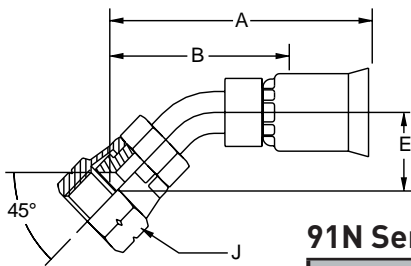

91N Series Permanent

*Part Number	C	Thread Size	Tube Size		A		Cutoff Allow. B		E		J Hex
			inch	mm	inch	mm	inch	mm	inch	mm	inch
#											
Hose Fitting			inch	inch	inch	mm	inch	mm	inch	mm	inch
17791N-6-6	+	5/8-18	-6	3/8	2.06	52	1-5/16	33	0.39	10	3/4
17791N-12-12	+	1-1/16-14	-12	3/4	3.07	78	2-7/16	62	0.78	20	1-1/4

* Steel tube, nipple, nut and shell.
 C - All components 303 stainless steel.

(+) Non Standard. See page ii for information on non-standard products.



17991N SAE 45° Swivel 90° Elbow

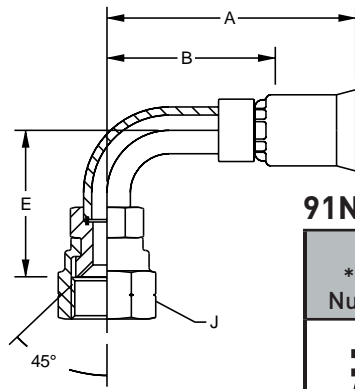

91N Series Permanent

*Part Number	C	Thread Size	Tube Size	A		Cutoff Allow. B		E		J Hex	
#											
Hose Fitting			inch	inch	inch	mm	inch	mm	inch	mm	inch
17991N-6-6	+	5/8-18	-6	3/8	2.06	52	1-5/16	49	1.19	30	3/4
17991N-12-12	+	1-1/16-14	-12	3/4	2.92	74	2-1/8	54	1.82	46	1-1/4

* Steel tube, nipple, nut and shell.
 C - All components 303 stainless steel.

1AL91N A-LOK® Compression

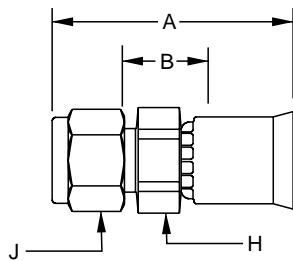

91N Series Permanent

Part Number (w/ nut/ferrules)	Part Number (w/o nut/ferrules)	C	Tube Size	A		Cutoff Allow. B		H Hex	J Hex	
#	#									
Hose Fitting	Hose Fitting		inch	inch	inch	mm	inch	mm	inch	
1AL91N-4-4 (+)	1AL91N-4-4N (+)		-4	1/4	1.30	33	7/16	11	1/2	9/16
1AL91N-4-5 (+)	1AL91N-4-5N (+)		-5	1/4	1.35	34	7/16	11	1/2	9/16
1AL91N-6-6 (+)	1AL91N-6-6N (+)		-6	3/8	1.53	39	1/2	13	5/8	11/16
1AL91N-8-8 (+)	1AL91N-8-8N (+)		-8	1/2	1.61	41	7/16	11	13/16	7/8
1AL91N-12-12 (+)	1AL91N-12-12N (+)		-12	3/4	1.86	47	1/2	13	1-1/8	1-1/8
1AL91N-16-16 (+)	1AL91N-16-16N (+)		-16	1	2.11	58	7/16	11	1-3/8	1-1/2

C - 316 stainless steel nipple, nut, ferrules; 303 stainless steel shell.

Note: Nut part No. is XNUX-316; front ferrule part No. is XFFX-316; back ferrule part No. is XBFX-316. X denotes dash size.

Please reference Instrument Tubing Selection Guide, Bulletin 4200-TS, or contact the Instrumentation Connectors Division in Huntsville, Alabama, (Phone: 256-881-2040) directly for correct installation and application information.

(+) Non Standard. See page ii for information on non-standard products.

1P691N CPI® Compression (With Nut and Ferrule)

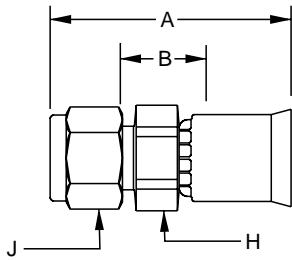

91N Series Permanent

Part Number	Tube Size	A		Cutoff Allow. B		H Hex	J Hex	
		inch	mm	inch	mm	inch	inch	
#								
Hose Fitting	inch	inch	inch	mm	inch	mm	inch	inch
1P691N-4-4C (+)	-4	1/4	1.30	33	7/16	11	1/2	9/16
1P691N-4-5C (+)	-5	1/4	1.35	34	7/16	11	1/2	9/16
1P691N-6-6C (+)	-6	3/8	1.53	39	1/2	13	5/8	11/16
1P691N-8-8C (+)	-8	1/2	1.61	41	7/16	11	13/16	7/8
1P691N-12-12C (+)	-12	3/4	1.86	47	1/2	13	1-1/8	1-1/8
1P691N-16-16C (+)	-16	1	2.06	58	7/16	14	1-3/8	1-1/2

C - 316 stainless steel nipple, nut and ferrule; 303 stainless steel shell.

Note: Nut part No. is XBZ-SS; ferrule part No. is XTZ-SS. X denotes dash size.

Please reference Instrument Tubing Selection Guide, Bulletin 4200-TS, or contact the Instrumentation Connectors Division in Huntsville, Alabama, (Phone: 256-881-2040) directly for correct installation and application information.

1FN91N Sanitary Flange

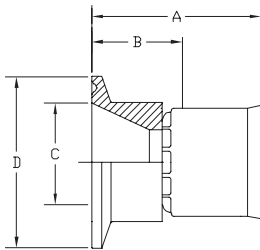

91N Series Permanent

Part Number	Flange Size D	A		Cutoff Allow. B		C		
		inch	mm	inch	mm	inch	mm	
#								
Hose Fitting	inch	inch	inch	mm	inch	mm	inch	mm
1FN91N-16-8C (+)	-8	1.98	1.69	43	1	25	0.87	22
1FN91N-16-10C (+)	-10	1.98	1.72	44	1-1/16	27	0.87	22
1FN91N-16-12C (+)	-12	1.98	1.82	46	1-1/16	27	0.87	22
1FN91N-16-16C (+)	-16	1.98	1.96	50	1-1/16	27	0.87	22
1FN91N-24-8C (+)	-8	1.98	2.33	59	1-5/8	41	1.37	43
1FN91N-24-12C (+)	-12	1.98	1.73	58	7/8	22	1.37	35
1FN91N-24-20C (+)	-20	1.98	2.20	56	15/16	24	1.37	35

C - 316L stainless steel nipple, 303 stainless steel shell.

1FV91N Mini Sanitary Flange

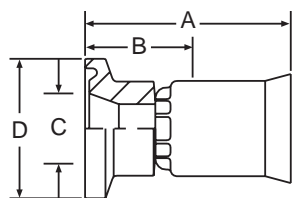

91N Series Permanent

Part Number	Flange Size D	A		Cutoff Allow. B		C		
		inch	mm	inch	mm	inch	mm	
#								
Hose Fitting	inch	inch	inch	mm	inch	mm	inch	mm
1FV91N-8-8C (+)	-8	0.99	1.37	35	11/16	17	0.50	13
1FV91N-12-12C (+)	-12	0.99	1.59	40	13/16	21	0.75	19

C - 316L stainless steel nipple, 303 stainless steel shell.

(+) Non Standard. See page ii for information on non-standard products.

1J191N Female Seal-Lok™ Swivel 90° Elbow Long Drop

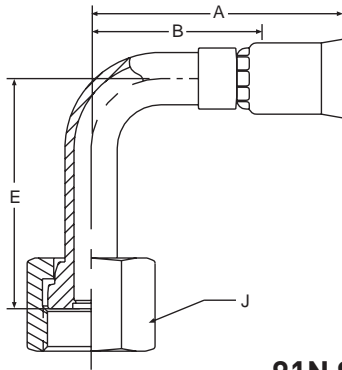

91N Series Permanent

*Part Number	C	Thread Size		Tube Size	A		Cutoff Allow. B		E		J Hex
#											
Hose Fitting			inch	inch	inch	mm	inch	mm	inch	mm	inch
1J191N-4-4		9/16-18	-4	1/4	1.66	42	1-1/16	27	1.80	46	11/16
1J191N-4-5 (+)	+	9/16-18	-5	5/16	1.78	45	1-1/16	27	1.80	46	11/16
1J191N-6-5 (+)	+	11/16-16	-5	5/16	1.92	49	1-3/16	30	2.13	54	13/16
1J191N-6-6	+	11/16-16	-6	3/8	1.92	49	1-3/16	30	2.13	54	13/16
1J191N-8-6 (+)	+	13/16-16	-6	3/8	2.00	51	1-9/16	40	2.51	43	15/16
1J191N-8-8	+	13/16-16	-8	1/2	2.15	58	1-7/16	37	2.51	64	15/16
1J191N-10-10 (+)	+	1-14	-10	5/8	1.25	32	1-9/16	40	2.76	70	1-1/8
1J191N-12-12 (+)	+	1-3/16-12	-12	3/4	2.65	67	1-13/16	46	3.78	96	1-3/8
1J191N-16-16 (+)	+	1-7/16-12	-16	1	3.15	80	2-1/4	57	4.50	114	1-1/2

* Steel tube, nipple, nut, and shell.

C – All components 303 stainless steel.

(+) Non Standard. See page ii for information on non-standard products.

1J791N Seal-Lok™ Swivel 45° Elbow

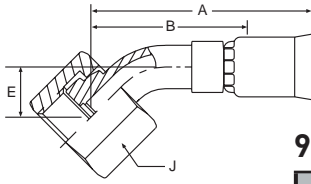

91N Series Permanent

*Part Number	C	Thread Size		Tube Size	A		Cutoff Allow. B		E		J Hex
#											
Hose Fitting			inch	inch	inch	mm	inch	mm	inch	mm	inch
1J791N-4-4	+	9/16-18	-4	1/4	1.73	44	1-1/4	32	0.41	10	11/16
1J791N-4-6 (+)	+	9/16-18	-6	3/8	1.91	49	1-5/16	33	0.41	10	11/16
1J791N-6-6	+	11/16-16	-6	3/8	2.02	51	1-3/8	35	0.43	11	13/16
1J791N-8-8	+	13/16-16	-8	1/2	2.18	55	1-1/2	38	0.59	15	15/16
1J791N-8-10 (+)	+	13/16-16	-8	1/2	2.39	61	1-11/16	43	0.59	15	15/16
1J791N-10-10	+	1-14	-10	5/8	2.47	63	1-3/4	44	0.59	43	1-1/8
1J791N-12-12	+	1-3/16-12	-12	3/4	2.74	58	1-15/16	49	0.81	21	1-3/8
1J791N-16-16	+	1-7/16-12	-16	1	3.50	89	2-1/2	64	0.94	24	1-5/8

* Steel tube, nipple, nut, and shell.
 C - All components 303 stainless steel.

1J991N Seal-Lok™ Swivel 90° Elbow

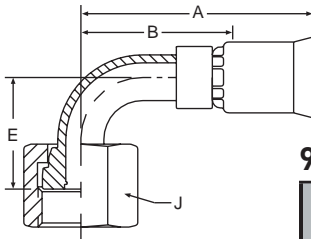

91N Series Permanent

*Part Number	C	Thread Size		Tube Size	A		Cutoff Allow. B		E		J Hex
#											
Hose Fitting			inch	inch	inch	mm	inch	mm	inch	mm	inch
1J991N-4-4	+	9/16-18	-4	1/4	1.79	45	1-1/4	32	0.82	21	11/16
1J991N-6-6	+	11/16-16	-6	3/8	1.87	47	1-1/4	32	0.90	23	13/16
1J991N-8-8	+	13/16-16	-8	1/2	2.07	53	1-3/8	35	1.15	29	15/16
1J991N-10-10	+	1-14	-10	5/8	2.23	57	1-1/2	38	1.27	32	1-1/8
1J991N-12-12	+	1-3/16-12	-12	3/4	2.63	67	1-7/8	48	1.85	43	1-3/8
1J991N-16-16	+	1-7/16-12	-16	1	3.45	58	2-9/16	65	2.21	56	1-5/8
1J991-20-20 (+)	+	1-11/16-12	-20	1-1/4	3.91	99	2-7/8	73	2.51	64	1-7/8

* Steel tube, nipple, nut, and shell.
 C - All components 303 stainless steel.

(+) Non Standard. See page ii for information on non-standard products.



1JC91N Seal-Lok™ Straight

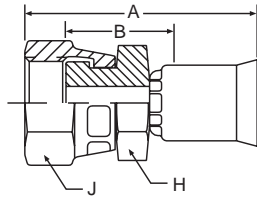

91N Series Permanent

*Part Number	B	C	Thread Size	A		Cutoff Allow. B		H Hex	J Hex	
#										
Hose Fitting				inch	inch	mm	inch	mm	inch	
1JC91N-4-4	+		9/16-18	-4	1.46	37	5/8	16	9/16	11/16
1JC91N-6-6	+		11/16-16	-6	1.62	41	11/16	17	5/8	13/16
1JC91N-8-8	+		13/16-16	-8	1.93	49	13/16	21	3/4	15/16
1JC91N-10-10	+		1-14	-10	2.05	52	7/8	22	15/16	1-1/8
1JC91N-12-10	+		1-3/16-12	-10	2.05	52	1-1/4	32	15/16	1-3/8
1JC91N-12-12	+		1-3/16-12	-12	2.05	58	1-1/4	32	15/16	1-3/8
1JC91N-16-16	+		1-7/16-12	-16	2.56	65	1-1/16	27	1-3/8	1-5/8
1JC91N-20-16	+	+	1-11/16-12	-16	2.30	58	1-3/8	35	1-5/8	1-7/8
1JC91-20-20	+	+	1-11/16-12	-20	2.68	68	1-11/16	43	1-11/16	1-7/8

* Steel nipple, nut, and shell.
 B – Brass nipple, brass nut, shell.
 C – All components 303 stainless steel.

1Q191N Ultra Seal

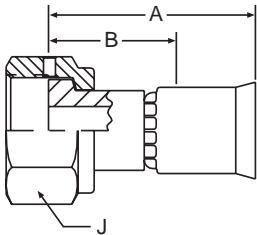

91N Series Permanent

Part Number	Thread Size	A		Cutoff Allow. B		J Hex		
#								
Hose Fitting		inch	inch	inch	mm	inch		
1Q191N-4-4C (+)	9/16-18	-4	1/4	1.63	41	3/4	19	11/16
1Q191N-6-6 C (+)	3/4-20	-6	3/8	1.81	46	7/8	22	7/8
1Q191N-8-8C (+)	7/8-20	-8	1/2	1.62	41	15/16	24	1
1Q191N-12-12C (+)	1-15/16-20	-12	3/4	1.93	49	1-1/8	29	1-1/2

C – 316L stainless steel nipple and nut; 303 stainless steel shell.

(+) Non Standard. See page ii for information on non-standard products.

1HV91N Male VacuSeal

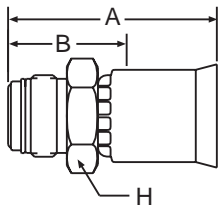

91N Series Permanent

Part Number	Thread Size			A		Cutoff Allow. B		H Hex
		inch	inch	inch	mm	inch	mm	inch
#								
Hose Fitting		inch	inch	inch	mm	inch	mm	inch
1HV91N-4-4C (+)	9/16-18	-4	1/4	1.59	40	1	25	3/4
1HV91N-6-6C (+)	7/8-14	-6	3/8	1.80	46	1	24	1-1/16
1HV91N-8-8C (+)	7/8-14	-8	1/2	1.89	48	1-1/16	27	1-1/16

C - 316L stainless steel nipple and nut; 303 stainless steel shell.

1VH91N Female VacuSeal

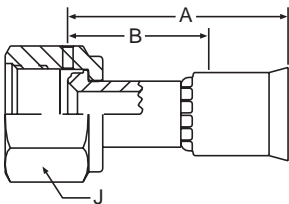

91N Series Permanent

Part Number	Thread Size			A		Cutoff Allow. B		H Hex
		inch	inch	inch	mm	inch	mm	inch
#								
Hose Fitting		inch	inch	inch	mm	inch	mm	inch
1VH91N-4-4C (+)	9/16-18	-4	1/4	1.59	40	1-1/16	27	3/4
1VH91N-8-6C (+)	7/8-14	-6	3/8	1.83	46	1-3/16	30	1-1/16
1VH91N-8-8C (+)	7/8-14	-8	1/2	1.94	49	1-3/16	30	1-1/16

C - 316L stainless steel nipple and nut; 303 stainless steel shell.

1TU91N Universal Tube Stub Fitting

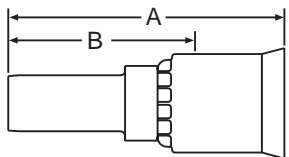

91N Series Permanent

Part Number			A		Cutoff Allow. B	
	inch	inch	inch	mm	inch	mm
#						
Hose Fitting	inch	inch	inch	mm	inch	mm
1TU91-2-3C	-3	1/8	1.33	34	7/8	22
1TU91-3-3C	-3	3/16	1.33	34	7/8	22
1TU91N-4-4C	-4	1/4	1.63	41	1-1/16	27
1TU91N-4-5C	-5	1/4	1.70	43	1-1/16	27
1TU91N-6-6C	-6	3/8	1.81	46	1-3/16	30
1TU91N-8-8C	-8	1/2	2.72	58	1-7/16	37
1TU91N-8-10C	-10	1/2	2.14	54	1-7/16	37
1TU91N-10-10C (+)	-10	5/8	2.14	54	1-7/16	37
1TU91N-12-12C	-12	3/4	2.24	57	1-7/16	37
1TU91N-16-16C	-16	1	2.73	69	1-3/4	44

C - 316 stainless steel nipple, 303 stainless steel shell.

(+) Non Standard. See page ii for information on non-standard products.



Hydraulic & Pneumatic Hose & Fit.

PTFE Hose & Fittings

Thermoplastic Tubing

Coiled Air Hose, Fittings & Accessories

Truck (Fleet) Products

Tooling & Equipment

Hose Accessories

Technical & Design Information

Approvals & Guides

Alphanumeric Index

19291N Female BSP Swivel

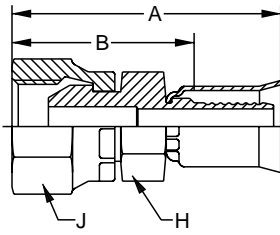

91N Series Permanent

*Part Number	B	C	Thread Size	Tube Size	A		Cutoff Allow. B		H Hex	J Hex	
#											
Hose Fitting				inch	inch	inch	mm	inch	mm	mm	mm
19291N-8-8	+	+	1/2-14	8	1/2	1.99	51	1-5/16	33	27	27
19291N-12-12	+	+	3/4-14	12	3/4	2.35	60	1-9/16	40	36	36

* Steel nipple, nut and shell.
 B - Brass nipple, brass nut, shell.
 C - All components 303 stainless steel.

1B291N Female BSP Swivel 90° Elbow

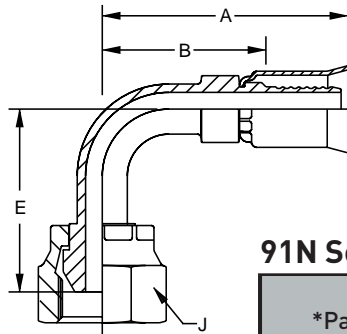

91N Series Permanent

*Part Number	B	C	Thread Size	Tube Size	A		Cutoff Allow. B		E		J Hex	
#												
Hose Fitting				inch	inch	inch	mm	inch	mm	inch	mm	mm
1B291N-8-8	+	+	1/2-14	8	1/2	2.04	52	1-3/8	35	1.57	40	27
1B291N-12-12 (+)	+	+	3/4-14	12	3/4	2.93	74	2-1/8	54	2.54	65	36

* Steel nipple, tube, nut and shell.
 B - Brass nipple, brass nut, shell.
 C - All components 303 stainless steel.

(+) Non Standard. See page ii for information on non-standard products.

10193N Male Taper Pipe Rigid

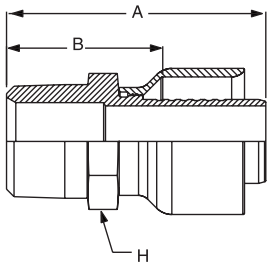

* Steel nipple and shell.

C - 316 stainless steel nipple, 303 stainless steel shell.

*Part Number	C	NPTF Thread Size	Hose I.D.	A		Cutoff Allow. B		H Hex
#								
Hose Fitting			inch	inch	mm	inch	mm	inch
10193N-8-8		1/2-14	1/2	2.09	53	1-1/2	38	7/8
10193N-12-12		3/4-14	3/4	2.70	69	1-5/8	41	1-1/8
10193N-16-16		1-11-1/2	1	3.03	77	1-13/16	46	1-3/8
10193N-20-20		1-1/4-11-1/2	1-1/4	3.20	58	1-7/8	48	1-11/16
10193N-24-24		1-1/2-11-1/2	1-1/2	3.76	96	2-1/16	52	2
10193N-32-32		2-11-1/2	2	3.97	101	2-5/16	59	2-1/2

10293N Female Taper Pipe Rigid

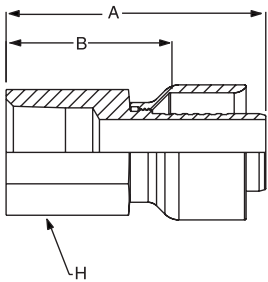

* Steel nipple and shell.

C - 316 stainless steel nipple, 303 stainless steel shell.

*Part Number	C	NPTF Thread Size	Hose I.D.	A		Cutoff Allow. B		H Hex
#								
Hose Fitting			inch	inch	mm	inch	mm	inch
10293N-8-8 (+)	+	1/2-14	1/2	2.36	60	1-3/4	44	7/8
10293N-12-12 (+)	+	3/4-14	3/4	2.90	74	1-13/16	46	1-1/8
10293N-16-16 (+)	+	1-11-1/2	1	3.28	83	2-1/16	52	1-3/8
10293N-20-20 (+)	+	1-1/4-11-1/2	1-1/4	3.37	86	2-1/16	52	1-3/4
10293N-24-24 (+)	+	1-1/2-11-1/2	1-1/2	3.84	98	2-1/8	54	2
10293N-32-32 (+)	+	2-11-1/2	2	3.83	58	2-1/8	54	2-1/2

10693N (JIC) 37° Female Swivel

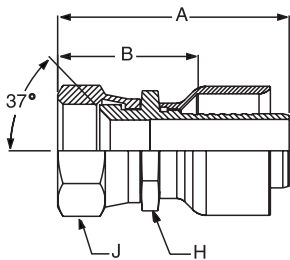

* Steel nipple, nut and shell.

C - 316 stainless steel nipple, 303 stainless steel nut and shell.

*Part Number	C	Thread Size	Hose I.D.	A		Cutoff Allow. B		H Hex	J Hex
#									
Hose Fitting			inch	inch	mm	inch	mm	inch	inch
10693N-6-6	+	9/16-8	3/8	1.69	43	1-3/32	28	3/4	11/16
10693N-8-8		3/8-16	1/2	2.02	51	1-3/8	35	7/8	7/8
10693N-10-10		7/8-14	5/8	2.51	64	1-11/16	43	1	1
10693N-12-12		1-1/16-12	3/4	2.86	73	1-3/4	44	1-1/8	1-1/4
10693N-16-16		1-5/16-12	1	3.11	79	1-13/16	46	1-3/8	1-1/2
10693N-20-20		1-5/8-12	1-1/4	3.28	83	2	51	1-3/4	2
10693N-24-24		1-7/8-12	1-1/2	3.92	58	2-1/4	57	2	2-1/4
10693N-32-32		2-1/2-12	2	4.12	105	2-7/16	62	2-1/2	2-7/8

[+] Non Standard. See page ii for information on non-standard products.

13793N JIC 37° Swivel 45° Elbow

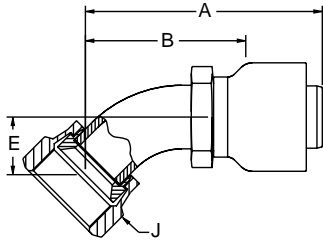

*Part Number	C	NPTF Thread Size	Hose I.D.	A		Cutoff Allow. B		E		J Hex
				inch	mm	inch	mm	inch	mm	inch
#										
Hose Fitting			inch	inch	mm	inch	mm	inch	mm	inch
13793N-6-6	+	9/16-18	-6	2.04	52	1-7/16	37	.39	10	7/8
13793N-8-8 (+)	+	3/4-16	-8	2.31	59	1-5/8	41	.55	14	7/8
13793N-10-10 (+)	+	7/8-14	-10	2.56	65	1-15/16	49	.64	16	1
13793N-12-12 (+)	+	1-1/6-12	-12	3.37	86	2-1/4	57	.78	20	1-1/4
13793N-16-16 (+)	+	1-5/16-12	-16	3.71	94	2-5/8	67	.90	23	1-1/2
13793N-20-20 (+)	+	1-5/8-12	-20	4.06	103	2-3/4	70	1.18	43	2
13793N-24-24 (+)	+	1-7/8-12	-24	5.76	58	4-1/4	108	1.47	37	2-1/4
13793N-32-32 (+)	+	2-1/2-12	-32	7.04	179	5-5/8	143	2.06	52	2-7/8

* Steel nipple, tube, nut and shell.
 C - 316 stainless steel nipple, tube and nut; 303 stainless steel shell.

13993N JIC 37° Swivel 90° Elbow

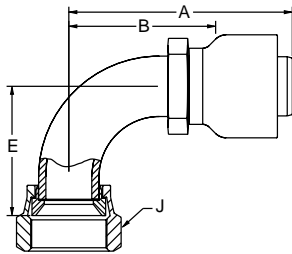

*Part Number	C	NPTF Thread Size	Hose I.D.	A		Cutoff Allow. B		E		J Hex
				inch	mm	inch	mm	inch	mm	inch
#										
Hose Fitting			inch	inch	mm	inch	mm	inch	mm	inch
13993N-8-8	+	3/4-16	-8	2.20	56	1-9/16	40	1.09	28	7/8
13993N-10-10	+	7/8-14	-10	2.41	61	1-11/16	43	1.23	31	1
13993N-12-12	+	1-1/6-12	-12	3.28	83	2-3/16	56	1.82	46	1-1/4
13993N-16-16	+	1-5/16-12	-16	3.71	94	2-1/2	64	2.14	54	1-1/2
13993N-20-20	+	1-5/8-12	-20	3.89	99	2-9/16	65	2.57	43	2
13993N-24-24	+	1-7/8-12	-24	5.72	58	4-1/4	108	3.17	81	2-1/4
13993N-32-32 (+)	+	2-1/2-12	-32	6.47	164	5-1/16	129	4.59	117	2-7/8

* Steel nipple, tube, nut and shell.
 C - 316 stainless steel nipple, tube and nut; 303 stainless steel shell.

(+) Non Standard. See page ii for information on non-standard products.

14K93N ANSI B16.5 Flange

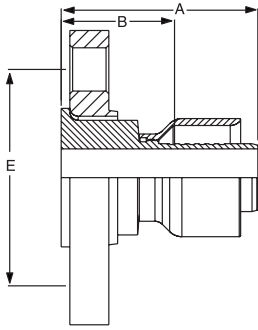

*Part Number	C	Hose I.D.	Flange Diameter		Cutoff Allow. B		Bolt Diameter E
#							
Hose Fitting		inch	inch	inch	mm	inch	mm
14K93N-8-8 (+)	+	1/2	3-1/2	2.03	52	1-3/8	35
14K93N-12-12 (+)	+	3/4	3-7/8	2.70	69	1-3/4	44
14K93N-16-16 (+)	+	1	4-1/4	2.84	72	1-5/8	41
14K93N-20-20 (+)	+	1-1/4	4-5/8	2.98	76	1-5/8	41
14K93N-24-24 (+)	+	1-1/2	5	3.45	88	1-3/4	44
14K93N-32-32 (+)	+	2	6	3.62	58	2	51

* Steel nipple and shell, 304 stainless steel flange.
 C - 316 stainless steel nipple, 304 stainless steel flange, 303 stainless steel shell.
 Also available in 96N series.

1FC93N Female Cam and Groove with BUNA N Gasket

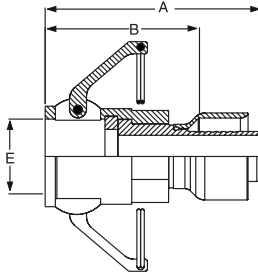

*Part Number	C	Hose I.D.	A		Cutoff Allow. B		E
#							
Hose Fitting		inch	inch	mm	inch	mm	inch
1FC93N-12-8 (+)	+	1/2	3.32	84	2-11/16	68	1.26
1FC93N-12-12 (+)	+	3/4	3.92	100	2-13/16	71.44	1.26
1FC93N-16-16 (+)	+	1	4.22	107	3	76.20	1.44
1FC93N-20-20 (+)	+	1-1/4	4.48	114	3-3/16	80.96	1.79
1FC93N-24-24 (+)	+	1-1/2	5.10	130	3-7/16	83.31	2.10
1FC93N-32-32 (+)	+	2	5.20	58	3-1/2	88.90	2.48

* Steel nipple and shell, 316 stainless steel nut.
 C - 316 stainless steel nipple and nut, 303 stainless steel shell.
 Meets Military Standards MIL-C-27487 and MS-27019.
 Also available in 96N series.

1MC93N Male Cam and Groove

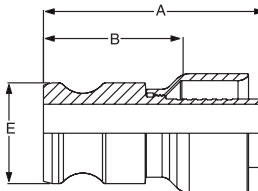

*Part Number	C	Hose I.D.	A		Cutoff Allow. B		E	
#								
Hose Fitting		inch	inch	mm	inch	mm	inch	mm
1MC93N-12-8 (+)	+	1/2	2.12	54	1-1/2	38	1.26	38.10
1MC93N-12-12 (+)	+	3/4	2.65	67	1-1/2	38	1.26	38.10
1MC93N-16-16 (+)	+	1	3.19	81	2	51	1.44	41.28
1MC93N-20-20 (+)	+	1-1/4	3.43	87	2-1/8	54	1.79	41.28
1MC93N-24-24 (+)	+	1-1/2	3.91	99	2-1/4	57	2.10	46.04
1MC93N-32-32 (+)	+	2	4.34	58	2-11/16	68	2.48	47.63

* Steel nipple and shell.
 C - 316 stainless steel nipple, 303 stainless steel shell.
 Meets Military Standards MIL-C-27487 and MS-27019.
 Also available in 96N series.

(+) Non Standard. See page ii for information on non-standard products.

1JC93N Seal-Lok™ Straight

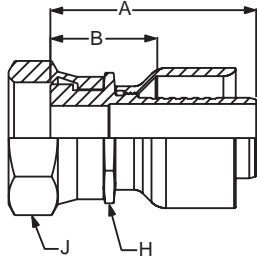

* Steel nipple, nut and shell.
C - 316 stainless steel nipple and nut, 303 stainless steel shell.
Also available in 96N series.

*Part Number	C	Thread Size	Hose I.D.	Tube Size	A		Cutoff Allow. B		H Hex	J Hex
#										
Hose Fitting			inch		inch	mm	inch	mm	inch	inch
1JC93N-8-8 (+)	+	13/16-16	1/2	1/2	2.08	53	1	25	15/16	15/16
1JC93N-10-10 (+)	+	1-14	5/8	5/8	2.21	56	1-1/4	32	15/16	1-1/4
1JC93N-12-12 (+)	+	1-3/16-12	3/4	3/4	2.30	58	1-3/8	35	1-3/8	1-3/8
1JC93N-16-16	+	1-7/16-12	1	1	2.61	66	1-3/8	35	1-3/8	1-5/8
1JC93N-20-20	+	1-11/16-12	1-1/4	1-1/4	2.65	67	1-5/16	33	1-7/8	1-7/8

1J793N Seal-Lok™ 45° Elbow

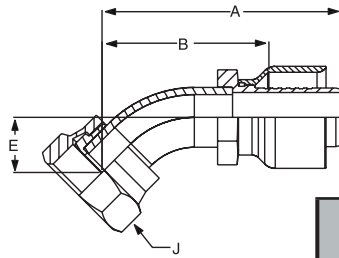

* Steel nipple, tube, nut and shell.
C - 316 stainless steel nipple, tube and nut; 303 stainless steel shell.
Also available in 96N series.

*Part Number	C	Thread Size	Hose I.D.	A		Cutoff Allow. B		E		J Hex
#										
Hose Fitting			inch	inch	mm	inch	mm	inch	mm	inch
1J793N-8-8 (+)	+	13/16-16	1/2	1.33	34	1-15/16	75	0.59	15	1
1J793N-10-10 (+)	+	1-14	5/8	2.91	74	2-1/16	53	0.59	15	1-1/8
1J793N-12-12 (+)	+	1-3/16-12	3/4	3.29	84	2-1/4	57	0.81	21	1-3/8
1J793N-16-16 (+)	+	1-7/16-12	1	4.05	103	2-13/16	71	0.94	24	1-5/8
1J793N-20-20 (+)	+	1-11/16-12	1-1/4	4.25	108	2-15/16	75	1.00	25	1-7/8

1J993N Seal-Lok™ 90° Elbow

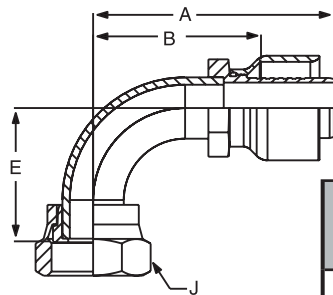

* Steel nipple, tube, nut and shell.
C - 316 stainless steel nipple, tube and nut; 303 stainless steel shell.
Also available in 96N series.

*Part Number	C	Thread Size	Hose I.D.	A		Cutoff Allow. B		E		J Hex
#										
Hose Fitting			inch	inch	mm	inch	mm	inch	mm	inch
1J993N-8-8 (+)	+	13/16-16	1/2	2.23	57	1-3/4	44	1.15	29	15/16
1J993N-10-10 (+)	+	1-14	5/8	2.67	68	1-7/8	48	1.27	32	1-1/4
1J993N-12-12 (+)	+	1-3/16-12	3/4	2.88	73	2	51	1.54	39	1-3/8
1J993N-16-16 (+)	+	1-7/16-12	1	4.00	102	2-3/4	70	2.21	56	1-5/8
1J993N-20-20 (+)	+	1-11/16-12	1-1/4	4.36	111	3-1/16	78	2.51	64	1-7/8

(+) Non Standard. See page ii for information on non-standard products.

10694 (JIC) 37° Female Swivel

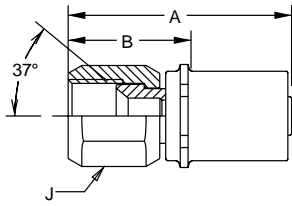

*Part Number	C	Thread Size	Tube O.D.	Hose Size	Tube Size	A		Cutoff Allow. B		J Hex
						inch	mm	inch	mm	
#										
Hose Fitting			inch	inch	inch	inch	mm	inch	mm	inch
10694-6-6	+	9/16-18	3/8	-6	3/8	1.76	45	15/16	24	11/16
10694-8-8	+	3/4-16	1/2	-8	1/2	2.09	53	1-3/16	30	7/8
10694-10-10	+	7/8-14	5/8	-10	5/8	2.30	58	1-5/16	33	1
10694-12-12	+	1-1/16-12	3/4	-12	3/4	2.45	62	1-5/16	33	1-1/4
10694-16-16	+	1-5/16-12	1	-16	1	2.72	69	1-7/16	37	1-1/2

Factory crimped only.
 *Steel nipple, nut and shell
 C - Stainless nipple, nut and shell

10695 (JIC) 37° Female Swivel

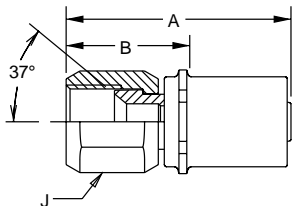

*Part Number	C	Thread Size	Tube O.D.	Hose Size	Tube Size	A		Cutoff Allow. B		J Hex
						inch	mm	inch	mm	
#										
Hose Fitting			inch	inch	inch	inch	mm	inch	mm	inch
10695-4-4	+	7/16-20	1/4	-4	1/4	1.47	37	13/16	21	9/16
10695-6-6	+	9/16-18	3/8	-6	3/8	1.76	45	15/16	24	11/16
10695-8-8	+	3/4-16	1/2	-8	1/2	2.09	53	1-3/16	30	7/8
10695-12-12	+	1-1/16-12	3/4	-12	3/4	2.45	62	1-5/16	33	1-1/4
10695-16-16	+	1-5/16-12	1	-16	1	2.72	69	1-7/16	37	1-1/2

Factory crimped only.
 *Steel nipple, nut and shell
 C - Stainless nipple, nut and shell

[+] Non Standard. See page ii for information on non-standard products.

Thermoplastic Tubing

Thermoplastic Tutorial and Information	172-173
Tubing Pressure Ranges.....	174
Tubing Compatibility Chart	175
Polyethylene.....	177-180
Nylon	181-184
Polypropylene	185
Polyurethane.....	186-190
Clear Vinyl.....	191
Burst Pressure/Temperature Charts	192-194

Hydraulic &
Pneumatic
Hose & Fit.

PTFE
Hose &
Fittings

Thermoplastic
Tubing

Coiled Air Hose,
Fittings
& Accessories

Truck (Fleet)
Products

Tooling &
Equipment

Hose
Accessories

Technical &
Design
Information

Approvals &
Guides

Alphanumeric
Index

DIMENSIONS ARE FOR REFERENCE ONLY. SUBJECT TO CHANGE.

(+) Non Standard. See page ii for information on non-standard products.





Parflex Thermoplastic Tubing Tutorial

- Review the general attributes of our thermoplastic tubing that follows- this provides an excellent overview for all of thermoplastic tubing in our product line
- Review the symbols pages- this will help clear up any questions you may have on the product tables within this section
- The market/applications table identifies and provides a “good fit” summary
- Review the pressure bar graph provided- this shows relative pressure ratings for the entire line of thermoplastic tubing
- Review the **STAMPED guide** (Size, Temperature, Media, Application, Pressure, End Configuration, and Delivered Preferences) **on page 173** to help narrow your search for the desired product
- Specific nomenclature, features, advantages, and benefits can be found at the beginning page of each product line

- All Plastic tubing dimensions are laser monitored to ensure an overall quality product
- Most Tubing sizes are packaged in convenient 100 ft., 250 ft., 500 ft. and 1,000 ft lengths

Polyethylene Tubing

- Parflex polyethylene tubing meets FDA, NSF Standard 51 for all food contact applications and NSF-61 for potable water applications
- Our E-Series tubing is made of 100% virgin resin material
- Polyethylene tubing meets ASTM D-1693 for stress crack resistance
- We also offer special PE tubing: FRPE (flame retardant & plenum rated) as well as HDPE (high density)

Nylon Tubing

- Flexible Nylon tubing use high grade resins for strength and flexibility for routing in tight spaces
- Semirigid high strength Nylon use high grade resins without the addition of plasticizers for higher pressure tubing applications
- Pure Air Tubing (PAT) is the tubing choice for pure air systems (Semiconductor) due to its cleanliness in addition to excellent chemical and UV light resistance

Polypropylene

- Polypropylene tubing meets FDA, NSF Standard 51 for all food contact applications
- Polypropylene tubing exhibits excellent chemical resistance to chlorinated water applications
- Polypropylene tubing is commonly used in outdoor applications where UV light stabilization is required

Polyurethane

- Polyurethane tubing is a flexible, kink resistant and abrasion resistant material commonly used in Pneumatic applications
- Polyurethane is available in multiple transparent and opaque colors for system color coding
- Polyurethane is available in the following durometers (measurement of material hardness):
 - Medium Durometer (90-less flexible)
 - High Durometer (→95-least flexible, highest pressures)

Polyvinyl Chloride (PVC)

- PVC tubing is made from 100% virgin resin material and Meets all FDA specifications for materials in contact with food and drugs
- PVC tubing is very flexible (70 Durometer) tubing that is crystal clear and is Ideal for situations where visible fluid flow is necessary (i.e. sight gages for tank identification)

Product Family	Series	Suggested Markets and Applications
Polyethylene	E and EB	Potable water, chemical transfer, and low cost, low pressure pneumatics, NSF-51 & NSF- 61
	FRPE	Pneumatic controls in HVAC/plenum space (UL 1820), Dubl-Barb fitting from Parker Brass
High Density Polyethylene	HDPE	Chemical transfer and low cost pneumatics
Nylon	N	Pneumatic and petroleum-based chemical transfer
	PAT	Pure air and gas distribution systems, Semiconductor
	NR	High pressure pneumatic, lubrication, and Marine control systems
Polypropylene	PP and PPB	Food contact and chemical transfer applications, chlorinated water, NSF-51
Urethane	U and UM	Pneumatic controls requiring high flexibility, kink resistance and movement
	HU and HUM	High pressure pneumatics requiring flexibility and kink resistance. Robotics
Vinyl	PV	Low pressure chemical and medical applications requiring high clarity and flexibility, FDA

Add caveat for ordering Series EB and Series PPB NSF tubing with “-NSF” suffix



How To Select Thermoplastic Tubing (STAMPED)

- Size** Choose appropriate outside diameters - tubing is always measured on the OD
- Temperature** The maximum temperature of the material being conveyed
- Application** External conditions including abrasion, climate, heat, flexing, crushing, kinking, and degrees of bending
- Media** The composition of the substance being conveyed and chemical compatibility with the tubing
- Pressure** The maximum pressure of the system, including pressure spikes
- Ends** The appropriate end connection (barb, push to connect, compression)
- Delivery** Testing, quality, packaging, and delivery requirements

Hydraulic & Pneumatic Hose & Fit.

PTFE Hose & Fittings

Thermoplastic Tubing

Coiled Air Hose, Fittings & Accessories

Truck (Fleet) Products

Tooling & Equipment

Hose Accessories

Technical & Design Information

Approvals & Guides

Alphanumeric Index

Tubing Pressure Ranges

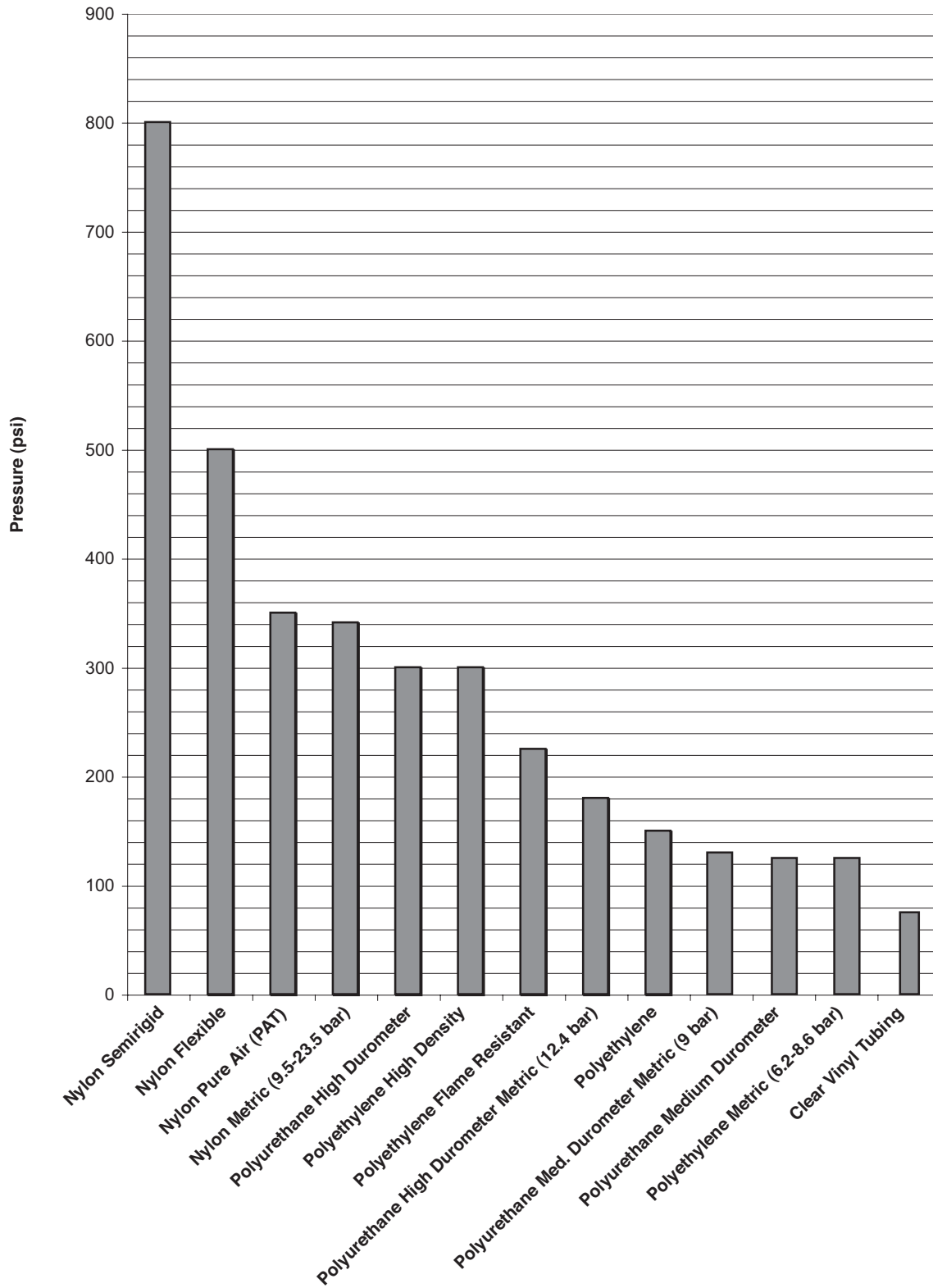

Note: Working pressures are at 73°F (23°C). Pressure ratings are also effected by diameter of tubing and wall thickness. Actual performance may vary with different media and working conditions. **Use this information for comparison only.**



Hydraulic & Pneumatic Hose & Fit.
PTFE Hose & Fittings
Thermoplastic Tubing
Coiled Air Hose, Fittings & Accessories
Truck (Fleet) Products
Tooling & Equipment
Hose Accessories
Technical & Design Information
Approvals & Guides
Alphanumeric Index

Tubeing Compatibility Chart

Courtesy of Brass Products Division



Fitting Line	Copper	Aluminum	Steel	Polyethylene E	Polyethylene FRPE	Nylon N	Nylon PAT	Nylon NR	Polypropylene PP	Polyurethane U	Vinyl	Nylon PFT J844	Diesel Fuel FL	SAE J1402 (HPD)	TFE	FEA	PFA
SAE 45° Flare	×	×	×														
Inverted Flare	×	×	×														
Compression	×	×		×†	×†	×†	×†	×†							×†	×†	×†
Compress-Align	×	×		×*	×	×*	×	×*							×	×	×
Metru-Lok	×	×		×*		×	×										
Poly-Tite®	×			×			×			×							
Dubl-Barb®				×	×												
Prestolok				×		×			×	×							
Prestolok II				×		×			×	×							
Microlok				×		×			×	×							
Flow Controls				×		×											
Prestomatic				×		×						×	×				
Prestolok				×		×						×	×				
Cartridges				×		×						×	×				
Air Brake-AB	×																
Air Brake-NTA®						×	×					×	×				
Transmission						×						×					
Ari Brake Hose Ends														×			
Vibra-Lok	×	×	×														
DAT						×	×					×	×				
Hose Barb														×			

Ratings are based on static pressure conditions
 * Tube support is recommended
 ** Clamp required
 † Plastic sleeve and brass tube support is recommended

Tube Line Fabrication Guide for Leak Free Systems

Every hydraulic, pneumatic and lubrication system requires some form of tube line fabrication and fitting installation for completion. Proper fabrication and installation are essential for the overall efficiency, leak free performance, and general appearance of any system.

Start by planning ahead. After sizing the tube lines and selecting the appropriate style of fitting, consider the following in the design of your system:

1. Accessibility of joints
2. Proper routing of lines
3. Adequate tube line supports
4. Available fabricating tools

Routing of Lines

Routing of lines is probably the most difficult yet most significant of these system design considerations. Proper routing involves getting a connecting line from one point to another through the most logical path.

Always try to leave fitting joints as accessible as possible. Hard to reach joints are hard to assemble and tighten properly. Inaccessible joints are also more difficult and time consuming to service.



Hydraulic & Pneumatic Hose & Fit.
 PTFE Hose & Fittings
 Thermoplastic Tubing
 Coiled Air Hose, Fittings & Accessories
 Truck (Fleet) Products
 Tooling & Equipment
 Hose Accessories
 Technical & Design Information
 Approvals & Guides
 Alphanumeric Index

Polyethylene Tubing

Series E: Instrument Grade—FDA, NSF Listed
 Series EB: Ultraviolet Light Resistant

- FDA, NSF-51 and NSF-61 compliant black polyethylene tubing is also available and is denoted with the letters "NSF" in the part number.
- E series natural and colored tubing listed below meet FDA, NSF-51 and NSF-61 requirements for food contact applications.
- Economical.
- Resistant to environmental stress cracking. It greatly exceeds that of ordinary polyethylene tubing as measured by ASTM D-1693 (10% IGEPAL).
- Black (EB) tubing contains an ultraviolet inhibitor which is recommended for use in sunlit areas and in close proximity to high ultraviolet light sources.
- Available in black as well as nine other colors, as recommended by the Instrument Society of America.
- Chemically resistant and flexible.
- Extruded from high molecular weight resin for increased dimensional stability, uniformity and long-term strength.
- All tubing conforms to ASTM D-1248, Type I, Class A, Category 4, Grade E5.
- The recommended operating temperature range for service at rated pressures with compatible fluids is -80°F (-62°C) to +150°F (+66°C).

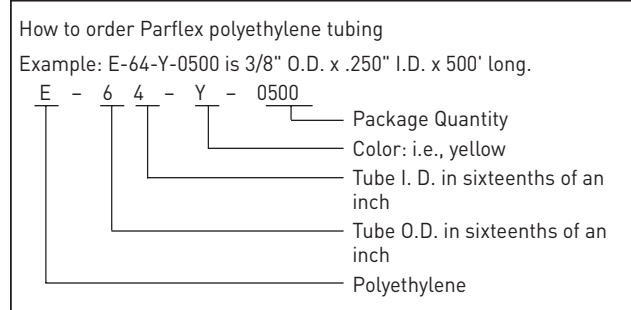

Fitting Recommendation:

- Parker TrueSeal™ fittings.
- Parker Fast & Tite® fittings.
- A tube support can be used with this tubing for maximum holding power where tensiling, vibration or pressure spikes may occur
- Parker Brass Fittings available from Brass Products Division
 Otsego, MI
 (269) 694-2550
 (269) 692-6634 FAX

Part Number	Color*	O. D. in.	I. D. in.	Avg. Wall Thick	Working Pressure at 73°F PSI	Min. Burst Pressure at 73°F PSI	Reel Length ft.	Min. Bend Radius in.	Weight lbs. Per 100 ft.
#									
E-43-XXXX E-43-X-XXXX EB-43-XXXX EB-43-XXXX-NSF	Natural R, B, O, Y, P, G, WHT, GRA Black Black NSF	1/4	.170	.040	120	480	0100, 0500, 1000 0100, 0500 0100, 0500, 1000 0500, 1000	1	1.1
E-53-XXXX EB-53-XXXX	Natural Black	5/16	.187	.062	145	580	0100, 0500	1-1/8	2.1
E-64-XXXX E-64-X-XXXX EB-64-XXXX EB-64-XXXX-NSF	Natural R, B, O, Y, P, G, WHT, GRA Black Black NSF	3/8	.250	.062	125	500	0100, 0500	1-1/4	2.5
E-86-XXXX E-86-X-XXXX EB-86-XXXX EB-86-XXXX-NSF	Natural WHT, GRA Black Black NSF	1/2	.375	.062	90	360	0100, 0500	2-1/2	3.6
E-108-XXXX EB-108-XXXX	Natural Black	5/8	.500	.062	70	280	0100	4	4.6

*Color Code: R = red, B = blue, O = orange, Y = yellow, P = purple, G = green, WHT = white, GRA = gray.
 Standard black is not NSF approved.

Metric Polyethylene Tubing

Series E: Instrument Grade—FDA, NSF Listed
 Series EB: Ultraviolet Light Resistant

Fitting Recommendation:

- Parker TrueSeal™ fittings.
- Parker Fast & Tite® fittings.
- A tube support can be used with this tubing for maximum holding power where tensiling, vibration or pressure spikes may occur
- Parker Metric Brass Fittings available from Brass Products Division
 Otsego, MI
 (269) 694-2550
 (269) 692-6634 FAX

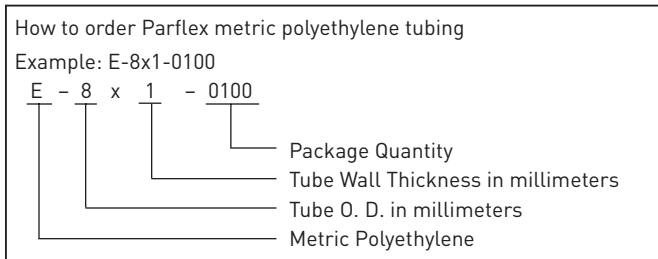

Part Number	Color	O. D. in.	I. D. in.	Wall Thick mm.	Working Pressure at 23°C bar	Min. Burst Pressure at 23°C bar	Reel Length ft.	Min. Bend Radius mm.	Weight lbs. Per 100 ft. (kg.)
#									
E-6X1-0100 EB-6X1-0100	Natural Black	6	4	1	8.6	34.5	100 100	25	1.3 (.59)
E-8X1-0100 EB-8X1-0100	Natural Black	8	6	1	6.9	27.6	100 100	38	1.4 (.64)
E-10X1.5-0100 EB-10X1.5-0100	Natural Black	10	7	1.5	8.6	34.5	100 100	38	2.6 (1.18)
E-12X1.5-0100 EB-12X1.5-0100	Natural Black	12	9	1.5	6.2	24.8	100 100	63	3.2 (1.45)

Hydraulic & Pneumatic Hose & Fit.

PTFE Hose & Fittings

Thermoplastic Tubing

Coiled Air Hose, Fittings & Accessories

Truck (Fleet) Products

Tooling & Equipment

Hose Accessories

Technical & Design Information

Approvals & Guides

Alphanumeric Index

Polyethylene Tubing

Series FRPE: Flame Resistant

Using the same base linear low density polyethylene (LLDPE) as the E-Series tubing, Parker Hannifin, Parflex Division's FRPE tubing has the following advantages:

- Excellent stress crack resistance. Meets requirements set forth in ASTM D-1693.
- UL 1820 approved as well as UL 94 V-2.
- Can be installed in accordance with NFPA Standard 90A.
- Self-extinguishing properties coupled with low smoke density characteristics.
- Numbering system allows the installer to identify up to 30 distinct circuits.
- The recommended operating temperature range for service at rated pressures with compatible fluids is -85°F (-65°C) to +150°F (+66°C).

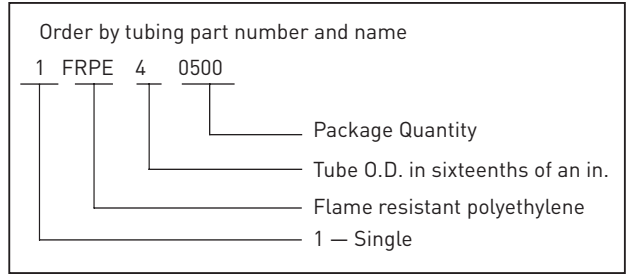

Part Number	Color	O. D. in.	I. D. in.	Avg. Wall Thick	Working Pressure at 73°F PSI	Min. Burst Pressure at 73°F PSI	Reel Length ft.	Min. Bend Radius in.	Weight lbs. Per 100
#									
1FRPE2.5-0500	Black	5/32	.096	.030	225	900	500	1/2	.053
1FRPE4-0250 1FRPE4-0500 1FRPE4-1000	Black Black Black	1/4	.170	.040	160	640	250 500 1000	3/4	1.17
1FRPE6-0250 1FRPE6-0500	Black Black	3/8	.250	.062	195	780	250 500	1-1/2	2.71
1FRPE8-0250	Black	1/2	.375	.062	135	540	250	1-3/4	3.80

Fitting Recommendation:

- Parker Brass Compression Double Barb
- Parker Brass Fittings available from Brass Products Division
Otsego, MI
(269) 694-2550
(269) 692-6634 FAX

Series HDPE: High Density

- Manufactured from high strength, high density polyethylene.
- Semirigid tubing that is inherently resistant to most chemicals, less easily cut or damaged and has a higher burst pressure rating than series E tubing.
- The recommended operating temperature range for service at rated pressures with compatible fluids is -80°F (-62°C) to +175°F (+80°C).

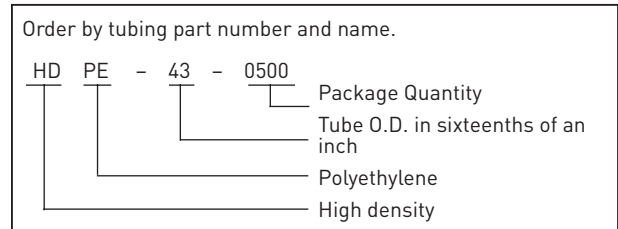

Part Number	Color	O. D. in.	I. D. in.	Avg. Wall Thick	Working Pressure at 73°F PSI	Min. Burst Pressure at 73°F PSI	Reel Length ft.	Min. Bend Radius in.	Weight lbs. Per 100 ft.
#									
HDPE-43-0250 HDPE-43-0500	Black Black	1/4	.170	.040	300	1200	250 500	1-1/2	1.1
HDPE-64-0250 HDPE-64-0500	Black Black	3/8	.250	.062	300	1200	250 500	2-1/2	2.5

Nylon Tubing

Series N: Flexible

- Made from high-grade, abrasion resistant, heat and light stabilized nylon.
- Resistance to stress cracking greatly exceeds that of ordinary nylon tubing.
- Exhibits extremely low level water absorption.
- Chemically resistant.
- Better flexibility, lighter weight and better resistance to flexural fatigue.
- The recommended operating temperature range for service at rated pressures with compatible fluids, depending upon conditions, is -65°F (-54°C) to +200°F (+93°C) continuous.
- Available in natural (NN), red (RED), green (GRN), blue (BLU), yellow (YEL), and black (NB).
- Black tubing is recommended for use outdoors and in sunlit areas.

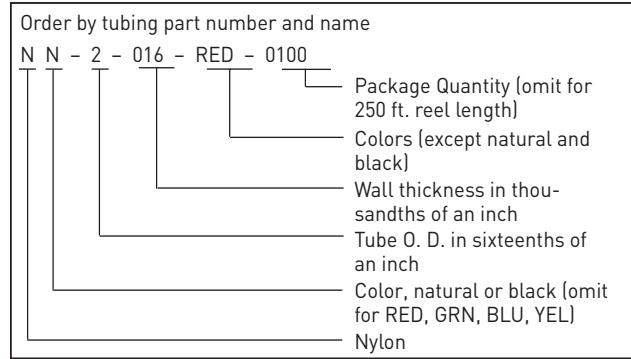

Fitting Recommendations:

- Parker TrueSeal™ fittings.**
- Parker Fast & Tite® fittings.**
- Parker Brass Fittings available from Brass Products Division
Otsego, MI
(269) 694-2550
(269) 692-6634 FAX

**Verify fitting working pressure meets application requirements.

Part Number	Color	Nom. Tube O. D. in.	Nom. Tube I. D. in.	Avg. Wall Thick	Working Pressure at 73°F PSI	Min. Burst Pressure at 73°F PSI	Std. Reel Length ft.	Min. Bend Radius in.	Weight lbs. Per 100 ft.
#									
NN-2-016 NB-2-016	Natural Black	1/8	.093	.016	250	1000	100, 250	1/4	0.25
NN-2-031 NB-2-031	Natural Black	1/8	.064	.031	500	2000	100, 250	1/4	0.42
NN-2.5-025 NB-2.5-025	Natural Black	5/32	.106	.025	300	1200	100, 250	1/2	0.47
NN-3-025 NB-3-025	Natural Black	3/16	.138	.025	250	1000	100, 250	5/8	0.58
NN-3-046 NB-3-046	Natural Black	3/16	.096	.046	500	2000	100, 250	7/16	0.93
NN-4-035 NB-4-035	Natural Black	1/4	.180	.035	250	1000	100, 250	7/8	1.10
NN-4-040 NB-4-040	Natural Black	1/4	.170	.040	310	1250	100, 250	7/8	1.20
NN-4-062 NB-4-062	Natural Black	1/4	.127	.062	500	2000	100, 250	1/2	1.70
NN-5-040 NB-5-040	Natural Black	5/16	.233	.040	250	1000	100, 250	1-1/8	1.56
NN-6-050 NB-6-050	Natural Black	3/8	.275	.050	250	1000	100, 250	1-1/8	2.34
NN-6-093 NB-6-093	Natural Black	3/8	.190	.093	500	2000	100, 250	3/4	3.80
NN-8-062 NB-8-062	Natural Black	1/2	.375	.062	250	1000	100, 250	1-1/4	3.94
NN-8-124 NB-8-124	Natural Black	1/2	.253	.124	500	2000	100, 250	1	6.70

*Suggested working pressure is 1/4 of burst pressure.
Metric part numbers on the following page.

Metric Nylon Tubing

Series N: Flexible

- Manufactured from our high standard, high-grade, abrasion resistant, heat and light stabilized flexible nylon.
- Metric nylon tubing has the same high chemical resistance and benefits of flexibility, light weight and resistance to flexural fatigue as our standard nylon tubing.
- The recommended operating temperature range for service at rated pressures with compatible fluids is -54°C (-65°F) to 93°C (200°F) continuous.
- Available in natural and black. Others colors available upon request: green (GRN), red (RED), yellow (YEL), and blue (BLU).

Fitting Recommendations:

- Parker metric fittings available from:
Tube Fittings Division
Columbus, Ohio
Phone (614) 279-7070
- Parker Metric Brass Fittings available from
Brass Products Division
Otsego, MI
(269) 694-2550
(269) 692-6634 FAX

Order by tubing part number and name

N N 4 x .65 - BLU - 1000

Package Quantity (omit for standard reel length)

Color (omit for natural and black)

Wall thickness in millimeters

Tube O. D. in millimeters

Color, Natural N, Black B (omit for other colors)

Nylon

Part Number	Color	Nom. Tube O. D. mm.	Nom. Tube I. D. mm.	Avg. Wall Thick mm.	Working Pressure at 23°C bar	Min. Burst Pressure at 23°C bar	Std. Reel Length ft. (m)	Min. Bend Radius mm.	Weight lbs. Per 100ft. (k.g.)
#									
NN4X.65 NB4X.65	Natural Black	4	2.7	0.65	26	104	100 (30.5)	14	.49 (.22)
NN6X1 NB6X1	Natural Black	6	4.0	1.00	23.5	94	100 (30.5)	22	1.1 (.50)
NN8X1 NB8X1	Natural Black	8	6.0	1.00	17	68	100 (30.5)	29	1.6 (.73)
NN10X1 NB10X1	Natural Black	10	8.0	1.00	12.5	50	100 (30.5)	34	2.0 (.91)
NN12X1 NB12X1	Natural Black	12	10.0	1.00	11	44	100 (30.5)	45	2.4 (1.1)
NN14X1.5 NB14X1.5	Natural Black	14	11.0	1.50	15	60	100 (30.5)	57	4.2 (1.9)
NN16X1.5 NB16X1.5	Natural Black	16	13.0	1.50	12.5	50	100 (30.5)	74	4.9 (2.2)
NN18X1.5 NB18X1.5	Natural Black	18	15.0	1.50	10.5	42	100 (30.5)	92	5.5 (2.5)
NN20X1.5 NB20X1.5	Natural Black	20	17.0	1.50	9.5	38	100 (30.5)	112	6.2 (2.8)

To convert bar to PSI, multiply by 14.5.

Nylon Pure Air Tubing

Series PAT: Ultra Pure, UV Resistant

- Manufactured from a specially formulated nylon for use in pure air and gas distribution systems.
- Packaged on corrugated plastic reel with ends capped. Shipped in a plastic-lined container.
- Offers excellent chemical resistance and ultraviolet light resistance.
- Maintains good resistance to high ambient temperatures with low moisture absorption.
- Provides high tensile strength with excellent coupling retention in high-pressure, temperature and vibration environments.
- Sizes 1/4" and smaller are single wall tubing having superior heat and light resistance.
- Tubing sizes 3/8" O.D. and above are reinforced constructions intended for gas distribution system connections where there is no substantial movement between end couplings.
- The recommended operating temperature range for service at rated pressures with compatible fluids is -40°F (-40°C) to +200°F (+93°C).
- PAT tubing is rated for full vacuum service at 28 inch Hg.
- Available in black (BLK), brown (BRN), and silver (SIL).

Order by tubing part number and name

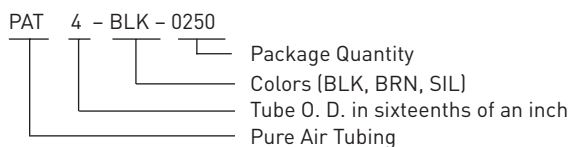

Fitting Recommendations:

- Parker Brass Fittings available from Brass Products Division
Otsego, MI
(269) 694-2550
(269) 692-6634 FAX

Nylon Part Number	Nom. Tube O. D. in.	Nom. Tube I. D. in.	Avg. Wall Thick in.	Working Pressure at 73°F PSI	Min. Burst Pressure at 73°F PSI	Std.** Reel Length ft.	Min. Bend Radius in.	Weight lbs. Per 100ft.
#								
PAT2	1/8	.079	.023	250	1000	1000	3/8	3.50
PAT4	1/4	.170	.040	300	1200	1000	1.0	12.41
PAT6	3/8	.251	.062	350	1400	500	1-1/0	28.22
PAT8	1/2	.376	.062	235	950	500	2.0	39.54
PAT10	5/8	.441	.092	225	900	250	2-1/2	70.21
PAT12	3/4	.566	.092	200	800	250	3.0	87.23

*Suggested working pressure is 1/4 of burst pressure.

**Other reel lengths may be available. Contact the Parflex Division for details.

Nylon Tubing

Series NR: Semirigid High Strength

- Manufactured from a semirigid nylon material. The tubing does not contain plasticizers.
- Offers better chemical resistance than series N, good resistance to high ambient temperature and low moisture absorption.
- Has a high tensile strength which will give excellent coupling retention in high-pressure, temperature and vibration environments.
- Specified for machine tool lubricating systems, marine control systems, process lines for chemicals and oils, and other applications requiring a high quality nylon tube.
- NR and NBR tubing meets UL94HB flame resistance ratings in wall thicknesses of .033" and greater.
- The recommended operating temperature range for service at rated pressures with compatible fluids is -60°F (-51°C) to +200°F (+93°C).

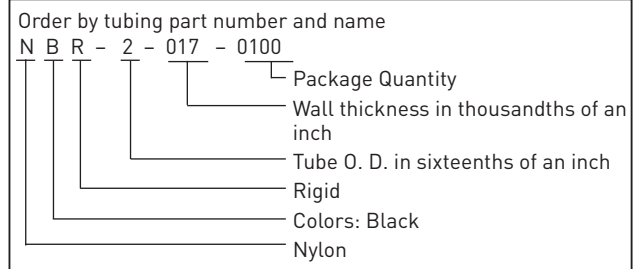

Fitting Recommendations:

- Parker TrueSeal™ fittings.
- Parker Fast & Tite® fittings.
- Parker Brass Fittings available from Brass Products Division Otsego, MI (269) 694-2550 (269) 692-6634 FAX

Part Number	Color	Nom. Tube O. D. in.	Nom. Tube I. D. in.	Avg. Wall Thick	Working Pressure at 73°F PSI	Min. Burst Pressure at 73°F PSI	Std. Reel Length ft.	Min. Bend Radius in.	Weight lbs. Per 100ft.
#									
NNR-2-017 NBR-2-017	Natural Black	1/8	.091	.017	425	1700	500	1/2	0.26
NNR-2-026 NBR-2-026	Natural Black	1/8	.073	.026	625	2500	500	3/8	0.36
NNR-3-024 NBR-3-024	Natural Black	3/16	.140	.024	425	1700	500	3/4	0.56
NNR-3-039 NBR-3-039	Natural Black	3/16	.110	.039	625	2500	500	5/8	0.82
NNR-4-035 NBR-4-035	Natural Black	1/4	.180	.035	425	1700	250	1	1.10
NNR-4-050 NBR-4-050	Natural Black	1/4	.150	.050	625	2500	250	7/8	1.40
NNR-5-040 NBR-5-040	Natural Black	5/16	.233	.040	425	1700	250	1-1/2	1.50
NNR-6-048 NBR-6-048	Natural Black	3/8	.279	.048	425	1700	250	1-3/4	2.20
NNR-6-075 NBR-6-075	Natural Black	3/8	.225	.075	625	2500	250	1-1/2	3.20
NNR-8-062 NBR-8-062	Natural Black	1/2	.375	.062	375	1500	250	2-3/8	3.80
NNR-8-075 NBR-8-075	Natural Black	1/2	.350	.075	625	2500	250	2-1/2	4.5

* Suggested working pressure is 1/4 of burst pressure.

NEW—Series NR nylon tubing is now available in 100 ft. bunch coil package lengths. To order, add suffix 0100 to part number. Example: NNR-4-035-0100

Polypropylene Tubing

Series PP: Laboratory Grade—FDA, NSF Listed
 Series PPB: Ultraviolet Light Resistant

- Acid and chemically resistant.
- Flexible.
- Dimensionally stable.
- May be used at higher temperatures and working pressures than polyethylene tubing.
- Resistance to hot water and hot corrosive acids is excellent. Polypropylene tubing will last many times longer than nylon tubing in hot water service.
- Has water absorption of less than .01%.
- Has good resistance to vegetable oils.
- Has excellent resistance to environmental stress cracking.
- Available in white, UV-resistant black and special NSF black.
- PPB series tubing has superior ultraviolet resistance.
- White and NSF black polypropylene meet FDA and NSF-51 requirements for food contact and potable water.
- NSF black polypropylene tubing is available upon special request. Add -NSF suffix to PPB part number.
- The recommended operating temperature range for service at rated pressures with compatible fluids is 0°F (-18°C) to +200°F (+93°C).

How to order Parflex polypropylene tubing

Example: PP-86-0250 is 1/2" O. D. x 3/8" I. D.

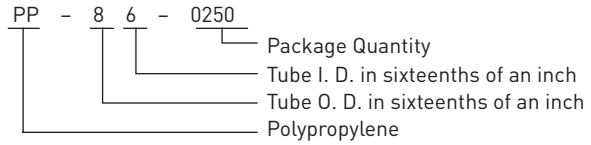

Fitting Recommendations:

- Parker TrueSeal™ fittings.
- Parker Fast & Tite® fittings.
- A tube support can be used with this tubing for maximum holding power where tensiling, vibration or pressure spikes may occur
- Parker Brass Fittings available from Brass Products Division
 Otsego, MI
 (269) 694-2550
 (269) 692-6634 FAX

Part Number	Color	Nom. Tube O. D. in.	Nom. Tube I. D. in.	Avg. Wall Thick in.	Working Pressure at 73°F PSI	Min. Burst Pressure at 73°F PSI	Reel Length ft.	Min. Bend Radius in.	Weight lbs. Per 100ft.
#									
PP-21-1000 PPB-21-1000	White Black	1/8	.080	.023	350	1400	1000	1/2	0.28
PP-32-0500 PPB-32-0500	White Black	3/16	.120	.034	350	1400	500	3/4	0.62
PP-43-0500 PPB-43-0500	White Black	1/4	.170	.040	300	1200	500	1	1.01
PP-53-0500 PPB-53-0500	White Black	5/16	.187	.062	350	1400	500	1-1/4	1.87
PP-64-0500 PPB-64-0500	White Black	3/8	.250	.062	300	1200	500	1-1/4	2.35
PP-86-0250 PPB-86-0250	White Black	1/2	.375	.062	225	900	250	2-1/2	3.28
PP-108-0100 PPB-108-0100	White Black	5/8	.500	.062	175	700	100	4	4.22

* Suggested working pressure is 1/4 of burst pressure.

Polyurethane Tubing

Series U: Polyether Base

- Medium durometer (90 to 95 Shore A).
- The tubing is tough, strong, kink resistant and abrasion resistant.
- Excellent hydrolytic stability.
- Flexible and easy to assemble onto designated fittings.
- Broad temperature range.
- Available in eight colors.
- High quality, precision made tubing used in a wide range of demanding and critical applications.
- Polyurethane occupies a unique position among polymers, sharing the best properties of both rubber and plastic. Parflex Series U tubing exhibits the elongation and recovery characteristics of rubber and the chemical resistance associated with plastics.
- Used for a wide variety of applications. Typical usage includes air tools, robotics, pneumatic logic and actuation systems, analytical instrumentation, vacuum equipment, pressure measurement apparatus, semiconductor equipment manufacturers and a variety of medical and laboratory applications.
- The recommended operating temperature range for service at rated pressures with compatible fluids is -40°F (-40°C) to +180°F (+82°C).

Order by tubing part number and name

U - 2 1 - BLK - 0500

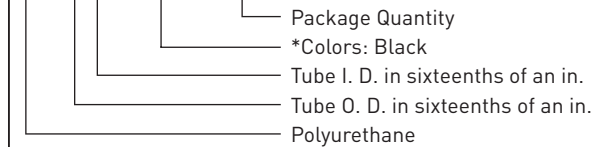

Fitting Recommendations:

- Parker TrueSeal™ fittings:
A tube support should be used with this tubing, sizes -64 and -86, for maximum fitting holding power.
- Parker Fast & Tite® fittings:
Requires use of a tube support
- Parker polyurethane Fast-Stor® fittings.
- Parker Par-Barb fittings.
- Parker Brass Fittings including MicroLok fittings available from:
Brass Products Division
Otsego, Michigan
(269) 694-2550
(269) 692-6634 FAX

Also available in coils

Part Number	Nom. Tube O. D. in.	Nom. Tube I. D. in.	Wall Thick in.	Working Pressure at 73°F PSI	Min. Burst Pressure at 73°F PSI	Coil Length ft.	Weight lbs. Per 100ft.
#							
U-21-0050 U-21-0250 U-21-0500 U-21-1000	1/8	1/16	1/32	125	375	50 250 500 1000	0.46
U-32-0050 U-32-0250 U-32-0500	3/16	1/8	1/32	125	375	50 250 500	0.76
U-42-0050 U-42-0250 U-42-0500 U-42-1000	1/4	1/8	1/16	125	375	50 250 500 1000	1.80
U-64-0050 U-64-0100 U-64-0250 U-64-0500	3/8	1/4	1/16	125	375	50 100 250 500	3.00
U-85-0050 U-85-0100 U-85-0250	1/2	21/64	.086	125	375	50 100 250	4.40
U-86-0050 U-86-0250 U-86-0500	1/2	3/8	1/16	85	255	50 100 250	4.20
U-96-0050 U-96-0100	9/16	3/8	3/32	125	375	50 100	6.80
U-128-0050 U-128-0100	3/4	1/2	1/8	125	375	50 100	12.00

** Suggested working pressure is 1/3 of burst pressure.

Metric part numbers on the following page.

*Colors: Clear-Blank, Black-BLK, Green-GRN, Red-RED, Yellow-YEL, Blue-BLU, Orange-ORG, Gray-GRA

Metric Polyurethane Tubing

Series U: Polyether Base

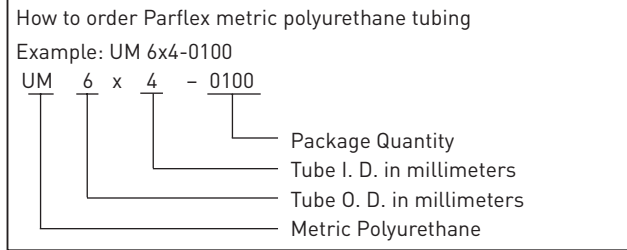

Part Number	Nom. Tube O. D. mm.	Nom. Tube I. D. mm.	Wall Thick mm.	Working Pressure at 23°C bar	Min. Burst Pressure at 34°C bar	Coil Length ft. (m)	Weight lbs. Per 100ft.
#							
UM4x2.5-0100 UM4x2.5-0250 UM4x2.5-0500	4	2.5	0.75	9	26	100 (30.5m) 250 (76.2m) 500 (152.4m)	0.06 (.027)
UM6x4-0100 UM6x4-0250 UM6x4-0500	6	4.0	1.00	9	26	100 (30.5m) 250 (76.2m) 500 (152.4m)	1.23 (.558)
UM8x5-0100 UM8x5-0250 UM8x5-0500	8	5.0	1.50	9	26	100 (30.5m) 250 (76.2m) 500 (152.4m)	2.40 (1.09)
UM10x6.5-0100 UM10x6.5-0250	10	6.5	1.75	9	26	100 (30.5m) 250 (76.2m)	3.55 (1.61)
UM12x8-0100 UM12x8-0250	12	8.0	2.00	9	26	100 (30.5m) 250 (76.2m)	4.92 (2.23)

HUFR MicroWeld™ Tubing

Part Number	Nom. Tube O. D. in.	Nom. Tube I. D. in.	Nom. Wall Thick in.	Max. Working Pressure at 73° F PSI	Min. Burst Pressure at 73° F PSI	Min. Bend Radius	Weight lbs. Per 100ft.
#							
HUFR-4-045-XX-0500	1/4	.160	.045	175	525	1/2	1.58
HUFR-6-062-XX-0500	3/8	.251	.062	150	450	3/4	3.33
HUFR-8-090-XX-0250	1/2	.320	.090	160	475	1	6.33

"XX" denotes color code

Metric sizes available upon request. Contact Parflex

Tube: Flame retardant, abrasion resistant, high durometer specially formulated ether based polyurethane

Colors: Black (BK), Blue (BL), Green (GN), White (WH). Other colors available upon request

Temperature Range: -40° F to +180° F (-40° C to +82° C)

Packaging: Cartons; 250ft or 500ft

Industry Standards: UL94 V-2 flame rating

Fittings: Push-to-Connect; (contact the Parker Brass Products Division for availability)

Note: Working pressure and burst pressure are at 73° F (23° C). Burst data was obtained in carefully controlled test conditions. Use this information for comparison only. Actual performance may vary with different media and working conditions. Pressure ratings lower at elevated temperatures.



Hydraulic & Pneumatic Hose & Fit.

PTFE Hose & Fittings

Thermoplastic Tubing

Coiled Air Hose, Fittings & Accessories

Truck (Fleet) Products

Tooling & Equipment

Hose Accessories

Technical & Design Information

Approvals & Guides

Alphanumeric Index

Polyurethane Tubing

Series HU: High Durometer

- Polyether base.
- Tough, strong, kink resistant and abrasion resistant.
- Excellent hydrolytic stability.
- Broad temperature range.
- Five colors.
- Has a Shore A hardness greater than 95 durometer. This high durometer enables the use of compression/push-to-connect fittings and significantly increases the working pressure versus standard polyurethane tubing.
- High quality, precision made tubing used in a wide range of demanding and critical applications.
- Polyurethane tubing occupies a unique position among polymers, sharing the best properties of both rubber and plastic. Urethane exhibits the elongation and recovery characteristics of rubber and the chemical resistance associated with plastics.
- Used for a wide variety of applications. Typical usage includes air tools, robotics, pneumatic logic and actuation systems, analytical instrumentation, vacuum equipment, pressure measurement apparatus, semiconductor equipment manufacturers and a variety of laboratory applications.
- The recommended operating temperature range for service at rated pressures with compatible fluids is -40°F (-40°C) to +180°F (+82°C).

Order by tubing part number and name

HU - 2 - BLK - 0500

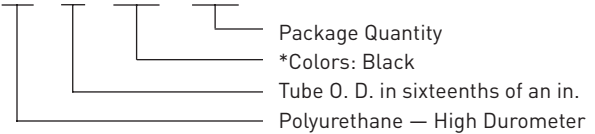

Fitting Recommendations:

- Parker TrueSeal™ fittings.
- Parker Brass Fittings and MicroLok fittings available from:
Brass Products Division
Otsego, Michigan
(269) 694-2550
(269) 692-6634 FAX

Also available in coils

Part Number	Nom. Tube O. D. in.	Nom. Tube I. D. in.	Wall Thick in.	Working Pressure at 73°F PSI	Min. Burst Pressure at 73°F PSI	Coil Length ft.	Weight lbs. Per 100ft.
#							
HU-2-0100 HU-2-0500	1/8	.063	.031	300	900	100 250 500	0.48
HU-2.5-0100 HU-2.5-0500	5/32	.094	.031	210	630	100 500	0.64
HU-4-0100 HU-4-0500	1/4	.160	.045	180	540	100 500	1.55
HU-6-0100 HU-6-0500	3/8	.250	.062	180	540	100 500	3.27
HU-8-0100 HU-8-0250	1/2	.320	.090	180	540	100 250	6.18
HU-12-0100 HU-12-0250	3/4	.467	.142	Contact Parflex Division for additional information.		100 250	

** Suggested working pressure is 1/3 of burst pressure.

Metric part numbers on the following page.

* Colors: Black-BLK, Red-RED, Navy Blue-DBL, Silver-SIL, Blue-BLU.

Consult Division concerning the following new color offerings: brown, gray, green, yellow, orange, clear, white, purple, light gray, neon pink, neon green, neon orange, and the following transparent colors: red, green, blue, yellow, orange, purple.

Metric Polyurethane Tubing

Series HUM: High Durometer (Metric)

- Polyether base.

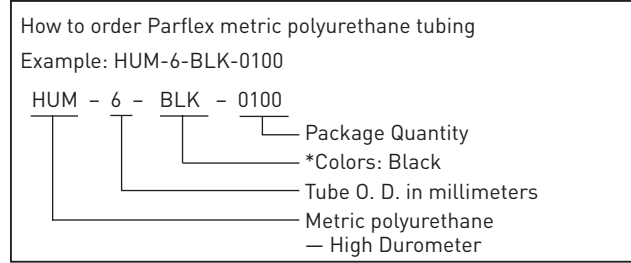

Part Number	Nom. Tube O. D. mm.	Nom. Tube I. D. mm.	Wall Thick mm.	** Working Pressure at 23°C bar	Min. Burst Pressure at 23°C bar	Coil Length ft.	Weight lbs. Per 100ft. (k.g.)
#							
HUM-4-0100 HUM-4-0500	4	2.4	0.80	12.4	37.2	100 500	.68 (0.31)
HUM-6-0100 HUM-6-0500	6	4.0	1.00	12.4	37.2	100 500	1.30 (.558)
HUM-8-0100 HUM-8-0250	8	5.0	1.50	12.4	37.2	100 500	2.59 (1.17)
HUM-10-0100 HUM-10-0250	10	6.5	1.75	12.4	37.2	100 250	3.84 (1.74)
HUM-12-0100 HUM-12-0250	12	8.0	2.00	12.4	37.2	100 250	4.92 (2.23)

**Suggested working pressure is 1/3 of burst pressure.

Note:

Metric urethane tubing is packaged in the following lengths:
 100 ft. (30.5 meters), 250 ft. (76.2 meters), 500 ft. (152.4 meters).

* Colors: Black-BLK, Red-RED, Navy Blue-DBL, Silver-SIL, Blue-BLU. Consult Division for availability of other color options.

Clear Vinyl Tubing

Parflex Clear Vinyl Tubing Formula Number V-1, Instrument and Laboratory Grade
 FDA Compliance

- Made from a virgin clear PVC (polyvinyl chloride) resin, specially formulated for exceptional purity, clarity and flexibility.
- Superior or equivalent to clear vinyl tubing available from any other source.
- Formula V-1 tubing fully meets all specifications called out by the United States Food and Drug Administration (FDA) for materials in contact with food and drugs for human consumption.
- 70 durometer for soft, easy handling and bending without tubing collapse.
- Crystal clear for fully visible fluid flow and excellent appearance.
- The recommended operating temperature range for service at rated pressures with compatible fluids is -40°F (-40°C) to +150°F (+65°C).

Fitting Recommendations:

- Tubing sizes 42, 43, 53, 64, 86 and 108 are made for use with Parker Fast & Tite® tube fittings. A tube support should be used with this tubing for maximum fitting holding power.
- Par-Barb insert barbed type fittings may be used with all sizes of Parflex clear vinyl tubing.
- Parker Brass Fittings are available from:
 Brass Products Division
 Otsego, Michigan
 Phone (616) 694-9411

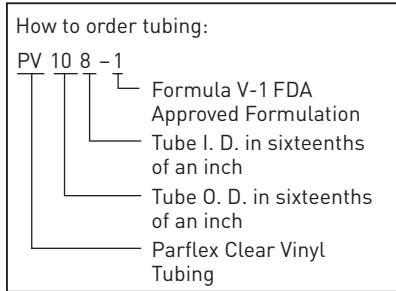

Crystal Clear Part Number	O. D. in.	I. D. in.	Avg. Wall Thick in.	Made from Virgin PVC Resins		Weight lbs. Per 100 ft.
				Working Pressure at	Standard Coil Length	
#						
PV21-1	1/8	1/16	1/32	35	100	0.48
PV32-1	.170	1/8	.025	35	100	0.58
PV42-1	1/4	1/8	1/16	65	100	2.52
PV43-1	1/4	.170	.040	55	100	1.35
PV403-1	1/4	3/16	1/32	22	100	1.11
PV53-1	5/16	3/16	1/16	55	100	2.51
PV63-1	3/8	3/16	3/32	65	100	4.26
PV73-1	7/16	3/16	1/8	75	100	6.28
PV54-1	5/16	1/4	1/32	20	100	1.42
PV64-1	3/8	1/4	1/16	55	100	3.15
PV74-1	7/16	1/4	3/32	60	100	5.18
PV84-1	1/2	1/4	1/8	70	100	7.55
PV75-1	7/16	5/16	1/16	50	100	3.7
PV85-1	1/2	5/16	3/32	60	100	6.15
PV95-1	9/16	5/16	1/8	70	100	8.80
PV86-1	1/2	3/8	1/16	45	100	4.41
PV96-1	9/16	3/8	3/32	50	100	7.06
PV106-1	5/8	3/8	1/8	60	100	10.07
PV97-1	9/16	7/16	1/16	40	100	5.03
PV107-1	5/8	7/16	3/32	45	100	8.04
PV117-1	11/16	7/16	1/8	50	100	11.49
PV108-1	5/8	1/2	1/16	30	100	5.66
PV118-1	11/16	1/2	3/32	40	100	8.94
PV128-1	3/4	1/2	1/8	45	100	12.59
PV138-1	13/16	1/2	5/32	60	100	16.70
PV129-1	3/4	9/16	3/32	40	100	9.94
PV139-1	13/16	9/16	1/8	45	100	13.84
PV1310-1	13/16	5/8	3/32	35	100	10.82
PV1410-1	7/8	5/8	1/8	40	100	15.11
PV1510-1	15/16	5/8	5/32	50	100	19.63
PV1411-1	7/8	11/16	3/32	30	100	11.83
PV1611-1	1	11/16	5/32	45	100	21.27
PV1612-1	1	3/4	1/8	35	100	17.62
PV1712-1	1-1/16	3/4	5/32	35	100	22.77
PV1812-1	1-1/8	3/4	3/16	50	100	28.32
PV2012-1	1-1/4	3/4	1/4	55	50	40.28
PV1814-1	1-1/8	7/8	1/8	30	50	20.14
PV1914-1	1-3/16	7/8	5/32	35	100	25.91
PV2014-1	1-1/4	7/8	3/16	45	50	32.10
PV2016-1	1-1/4	1	1/8	25	50	22.66
PV2116-1	1-5/16	1	5/32	30	50	29.03
PV2216-1	1/3/8	1	3/16	40	50	35.87
PV2416-1	1-1/2	1	1/4	45	50	50.35
PV2218-1	1-3/8	1-1/8	1/8	25	50	25.18
PV2420-1	1-1/2	1-1/4	1/8	20	50	27.69
PV2620-1	1-5/8	1-1/4	3/16	35	50	43.43
PV2820-1	1-3/4	1-1/4	1/4	45	50	60.42
PV3024-1	1-7/8	1-1/2	3/16	30	50	50.98
PV3224-1	2	1-1/2	1/4	40	50	70.49
PV3628-1	2-1/4	1-3/4	1/4	30	50	80.56
PV4032-1	2-1/2	2	1/4	35	50	90.63

Nylon Semi-Rigid Tubing

NR Series (NNR, NBR)
1/8 through 1/2 inch O. D.

Minimum Burst Pressure (PSig) (Thousands)

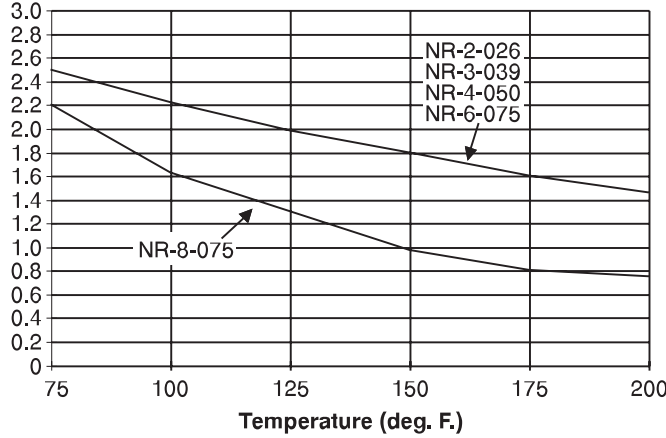

Nylon Flexible Tubing

N Series (NN, NB)
1/8 through 1/2 inch O. D.

Minimum Burst Pressure (PSig)

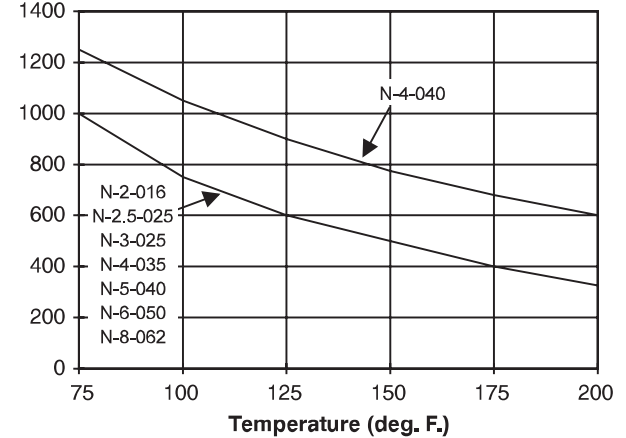

Nylon Semi-Rigid Tubing

NR Series (NNR, NBR)
1/8 through 1/2 inch O. D.

Minimum Burst Pressure (PSig) (Thousands)

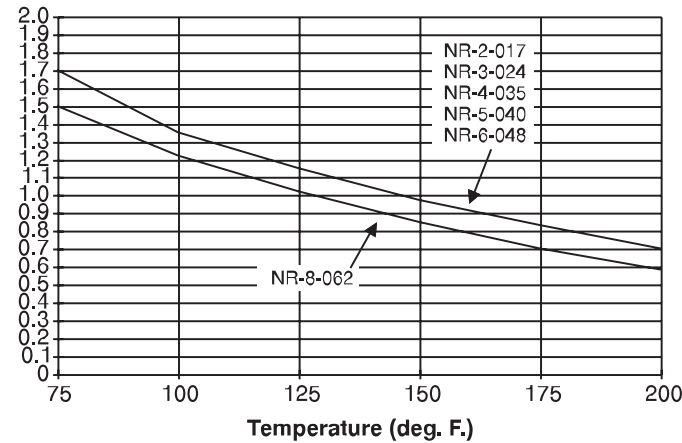

Nylon Flexible Tubing

N Series (NN, NB)
1/8 through 1/2 inch O. D.

Minimum Burst Pressure (PSig)

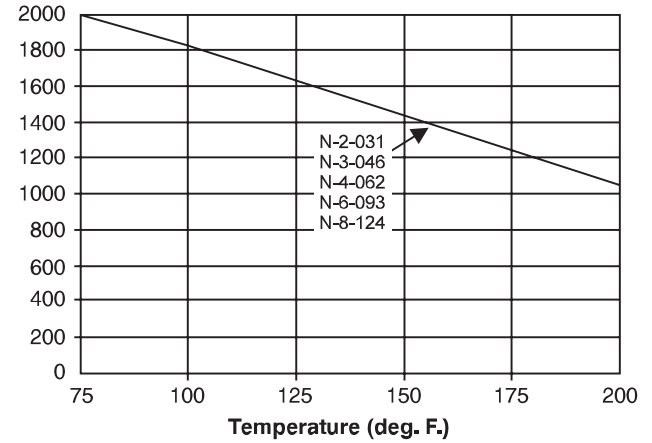

Suggested working pressure is 1/4 of burst pressure at system operating temperature.

Polyethylene Tubing

Laboratory Grade E Series
1/4 through 5/8 inch O. D.

Minimum
Burst
Pressure
(PSig)

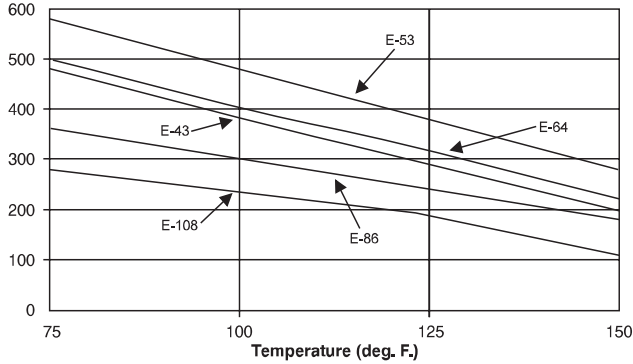

Similar curves for Poly-Flo® sizes
Consult Factory

Polypropylene Tubing

PP Series
1/8 through 5/8 inch O. D.

Minimum
Burst
Pressure
(PSig)
(Thousands)

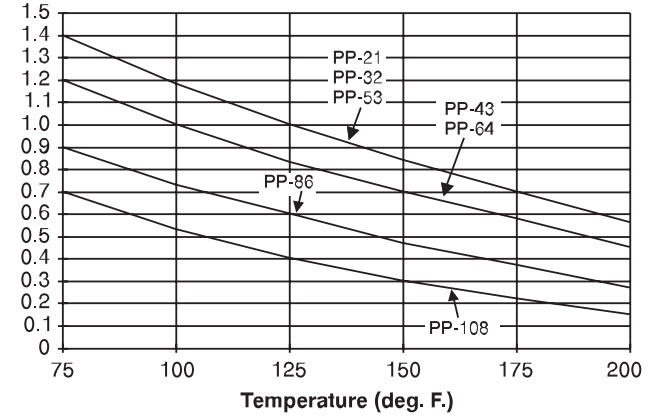

Polyethylene Tubing

High Density HDPE Series
1/4 through 5/8 inch O. D.

Minimum
Burst
Pressure
(PSig)

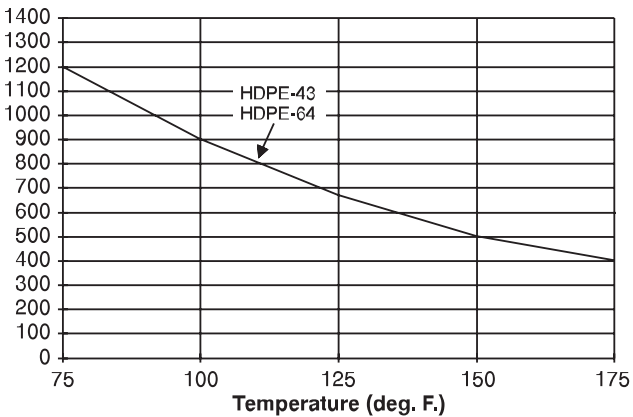

Suggested working pressures of nylon, polypropylene and polyethylene are 1/4 of burst pressure at system operating temperature.
Suggested working pressure of polyurethane is 1/3 of burst pressure at system operating temperature.

Hydraulic &
Pneumatic
Hose & Fit.

PTFE
Hose &
Fittings

Thermoplastic
Tubing

Coiled Air Hose,
Fittings
& Accessories

Truck (Fleet)
Products

Tooling &
Equipment

Hose
Accessories

Technical &
Design
Information

Approvals &
Guides

Alphanumeric
Index

Metric Nylon Tubing

N Series
4 millimeters through 12 millimeters O. D.

Minimum
Burst
Pressure (bar)

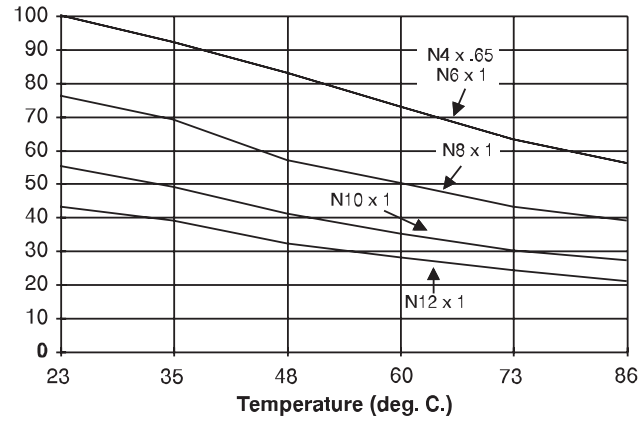

Metric Nylon Tubing

N Series
14 millimeters through 20 millimeters O. D.

Minimum
Burst
Pressure (bar)

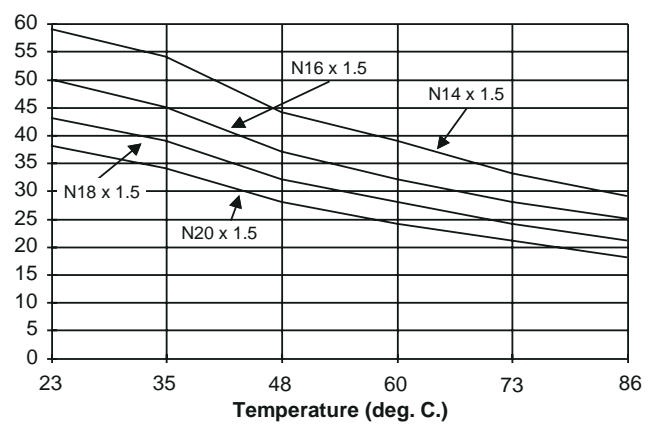

Metric Polyurethane Tubing

UM Series Polyether Base
4 through 12 millimeters O. D.

Minimum
Burst
Pressure (PSIg)

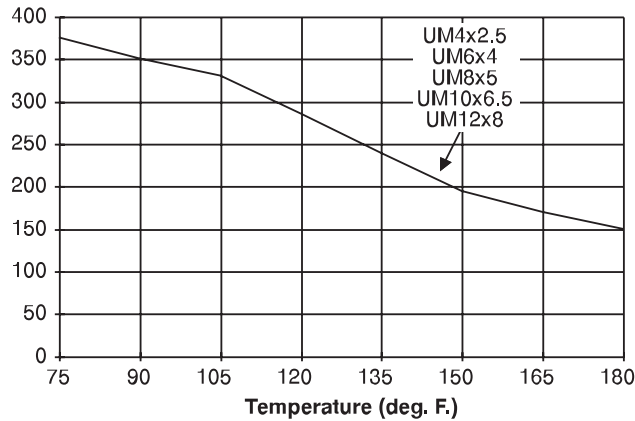

Polyurethane Tubing

U Series Polyether Base
1/8 through 3/4 inch O. D.

Minimum
Burst
Pressure (PSIg)

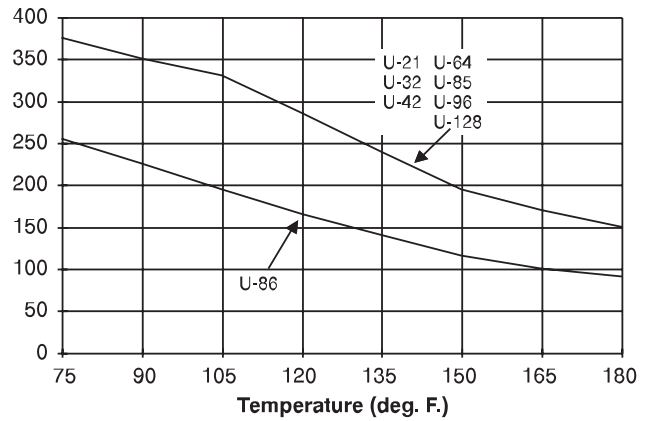

Hydraulic & Pneumatic Hose & Fit.

PTFE Hose & Fittings

Thermoplastic Tubing

Coiled Air Hose, Fittings & Accessories

Truck (Fleet) Products

Tooling & Equipment

Hose Accessories

Technical & Design Information

Approvals & Guides

Alphanumeric Index

Coiled Air Hose, Fittings & Accessories

Visual Index.....196

Fast-Stor® Air Hose198

Measuring Bulk Hose199

Fast-Stor® Fittings..... 200-202

Size Selection Procedure.....203

Typical Fast-Stor® Installation.....203

NoMar Polyurethane Fast-Stor® 204-206

Hydraulic &
Pneumatic
Hose & Fit.

PTFE
Hose &
Fittings

Thermoplastic
Tubing

Coiled Air Hose,
Fittings
& Accessories

Truck (Fleet)
Products

Tooling &
Equipment

Hose
Accessories









Technical &
Design
Information

Approvals &
Guides

Alphanumeric
Index

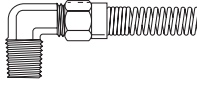
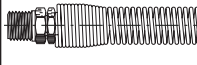
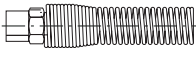
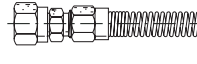
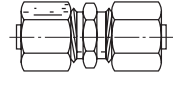
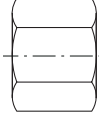
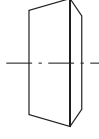
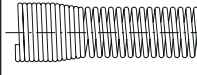
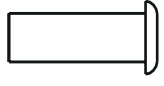
DIMENSIONS ARE FOR REFERENCE ONLY. SUBJECT TO CHANGE.

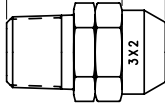
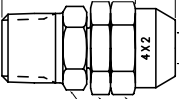

Coiled Air Hose, Fittings & Accessories					
<p>Fast-Stor® Coiled Air Hose</p> 	<p>Air Hose</p>  <p>pg. 198</p>	<p>Fittings & Accessories</p> 	<p>MC Male Connector</p>  <p>pg. 200</p>	<p>ME Male Elbow</p>  <p>pg. 200</p>	<p>ML Live Male Pipe Swivel</p>  <p>pg. 201</p>
<p>FC Female Connector</p>  <p>pg. 201</p>	<p>FL Female Pipe Swivel</p>  <p>pg. 201</p>	<p>UC Union Connector</p>  <p>pg. 202</p>	<p>FN Brass Nut</p>  <p>pg. 202</p>	<p>FR Plastic Ferrule</p>  <p>pg. 202</p>	<p>SG Steel Spring Guard</p>  <p>pg. 202</p>
<p>TS Tube Support</p>  <p>pg. 202</p>	<p>NoMar™ Polyurethane Fast-Stor® Coils</p> 	<p>Parflex NoMar Fast-Stor® Accessories</p>  <p>pg. 204</p>	<p>Urethane Fast-Stor® Coil</p>  <p>pg. 205</p>	<p>NoMar™ Polyurethane Fast-Stor® Fittings</p> 	<p>Male Pipe Rigid</p>  <p>pg. 206</p>
<p>Male Live Swivel</p>  <p>pg. 206</p>					

Fast-Stor® Air Hose

Fast-Stor® Self Retracting Air Hose, from Parflex, is manufactured from an extremely tough, abrasion resistant nylon. Fast-Stor® hose has excellent memory characteristics over a wide temperature range for long service life in the most rugged applications. The SAFETY YELLOW color of Fast-Stor® is highly desirable due to U.S. Government OSHA directives.

Service temperature range from -40°F to +200°F (-40°C to +93°C).



How to order: Fast-Stor Assemblies

Popular Stock Assemblies

Assembly Part Number	Fast-Stor Hose I. D.	Total Length of Hose ft.	Usable Length ft.	Fitting End #1	Fitting End #2 Live Swivel	Max. Working Pressure PSI*	Min. Burst at 73°F
#							
A0312-MC4-ML4	3/16	12	9	1/4" MPT	1/4" MPT	170	680
A0325-MC4-ML4	3/16	25	18	1/4" MPT	1/4" MPT	170	680
A0350-MC4-ML4	3/16	50	38	1/4" MPT	1/4" MPT	170	680
A0412-MC4-ML4	1/4	12	9	1/4" MPT	1/4" MPT	170	680
A0425-MC4-ML4	1/4	25	18	1/4" MPT	1/4" MPT	170	680
A0450-MC4-ML4	1/4	50	38	1/4" MPT	1/4" MPT	170	680
A0612-MC6-ML6	3/8	12	9	3/8" MPT	3/8" MPT	170	680
A0625-MC6-ML6	3/8	25	18	3/8" MPT	3/8" MPT	170	680
A0650-MC6-ML6	3/8	50	38	3/8" MPT	3/8" MPT	170	680
A0812-MC8-ML8	1/2	12	9	1/2" MPT	1/2" MPT	170	680
A0825-MC8-ML8	1/2	25	18	1/2" MPT	1/2" MPT	170	680
A0850-MC8-ML8	1/2	50	38	1/2" MPT	1/2" MPT	170	680

Bulk Hose

Assembly Part Number	Hose I. D.	Avg. Wall Thick in.	Hose Length ft.	Master Carton Quality	Coil Min. I. D.	Coil Max. O. D.	Max. Working Pressure PSI*	Min. Burst at 73°F
#								
FS-03-100	3/16	.023	100	600	2.0	2.5	170	680
FS-04-100	1/4	.030	100	600	3.0	3.7	170	680
FS-06-100	3/8	.045	100	400	4.5	5.5	170	680
FS-08-100	1/2	.062	100	400	6.5	7.8	170	680
FS-12-100	3/4	.075	100	100	12.0	14.0	170	680

*Maximum working pressure listed at 75°F or lower and based on safety factor of 4:1 over burst.

Measuring Fast-Stor® hose is quick and easy and may be accomplished by either of two accurate methods:

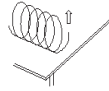

Position bulk length coils on work table extending away from you, cut-end up in 12:00 o'clock position.

1. Counting

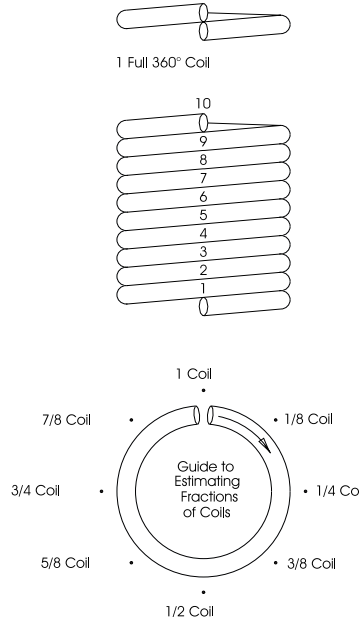

Total Length of Hose		Number of Coils Needed to Obtain Required Net Extended Length +3%				
Feet	Inches	3/16 I. D. Fast-Stor	1/4 I. D. Fast-Stor	3/8 I. D. Fast-Stor	1/2 I. D. Fast-Stor	3/4 I. D. Fast-Stor
3	36	5-1/8	3-1/2	2-1/4	1-5/8	7/8
5	60	8-1/2	5-3/4	3-7/8	2-5/8	1-1/2
7	84	12	8-1/8	5-3/4	3-3/4	1-1/8
10	120	17-1/8	11-1/2	7-3/4	5-3/8	3
12	144	20-1/2	13-7/8	9-1/4	6-1/2	3-1/2
15	180	25-3/4	17-3/8	11-1/2	8	4-1/2
16	192	27-3/8	18-1/2	12-3/8	8-5/8	4-3/4
17	204	29-1/8	19-5/8	13-1/8	9-1/8	5
19	216	30-7/8	20-3/4	13-7/8	9-5/8	5-3/8
20	240	34-1/4	23-1/8	15-3/8	10-3/4	6
25	300	42-7/8	28-7/8	19-1/4	13-3/8	7-1/2
30	360	51-3/8	34-5/8	23-1/8	16-1/8	8-7/8
33	396	56-1/2	38-1/8	25-3/8	17-3/4	9-3/4
50	600	85-5/8	57-3/4	38-1/2	26-7/8	14-7/8

2. Division into Even Numbers of Lengths

Bulk retracted lengths of Fast-Stor® hose are always exactly 100 feet long when shipped from factory. Some diameter expansion of the coils may have occurred in shipment due to temperature and storage conditions. This may appear to have shortened a given 100' retracted length slightly in relation to other 100' retracted lengths in the same master carton. The shorter appearance should not be mistaken for any actual shortage in extended length. A bulk retracted length may be easily divided into smaller lengths by first measuring the tightly retracted length in inches, and dividing by 4 to determine the cut off length for 25 feet, by 3 for 33 feet, by 8 for 12-1/2 feet, etc. Pieces should be tagged with their proper length before returning to storage.

How to Assemble Fast-Stor Hose

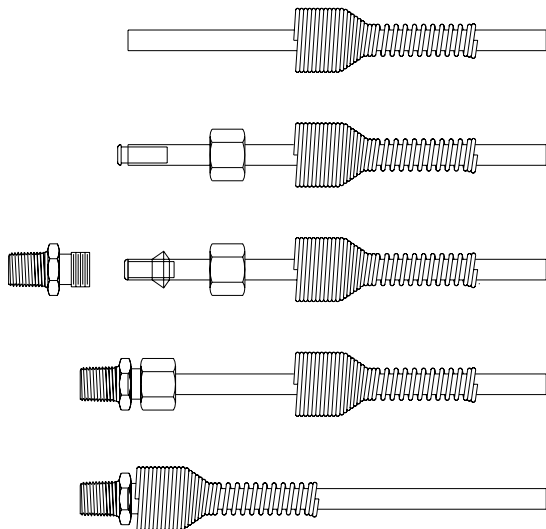

- Using a Parker Model 316 cutoff tool, Parflex PHC hand cutter or other sharp cutter, cut hose squarely to correct length.
- Install SG spring guard on hose as shown. A guard is not required on size -12 hose.
- Slide FN nut on hose and insert TS tube support.
- Slide FR plastic ferrule over hose with taper side toward cut end of hose. Size -12 hose uses a brass ferrule and requires the hose end to be dipped in clean water for lubrication.
- Push hose into fitting body until bottomed. Slide nut and ferrule up to fitting body and tighten nut by hand. With a wrench, tighten the nut additional 2 to 2-1/2 turns.
- Slide spring guard over nut until the lead coil snaps between the nut and fitting body hex.

Fittings

Fittings for Fast-Stor® hose are heavy duty brass construction with built in insert-supports. Fitting bodies are SAE Standard sizes. Hose entry length into the fittings is the longest in the industry due to Parflex's SAE body design and size standardization, assuring a strong grip on the hose.

All fitting part numbers include body, nut, ferrule and spring guard. For body only use Prefix B.

MC - Male Connector

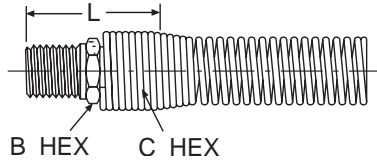

Part Number	Hose I.D.	End Type	End Size	L	B Hex	C Hex	Box Quantity
#							
MC-03-2	3/16	MPT-Straight	1/8 MPT	1-3/8	9/16	1/2	20
MC-03-4	3/16	MPT-Straight	1/4 MPT	1-9/16	9/16	1/2	20
MC-04-2	1/4	MPT-Straight	1/8 MPT	1-3/8	9/16	9/16	20
MC-04-4	1/4	MPT-Straight	1/4 MPT	1-9/16	9/16	9/16	20
MC-06-6	3/8	MPT-Straight	3/8 MPT	1-13/16	11/16	13/16	20
MC-08-6	1/2	MPT-Straight	3/8 MPT	2-1/8	7/8	15/16	20
MC-08-8	1/2	MPT-Straight	1/2 MPT	2-1/8	7/8	15/16	20
*MC-12-12	3/4	MPT-Straight	3/4 MPT	2-1/4	1-1/4	1-3/8	10

* No Spring Guard Required.

ME - Male Elbow

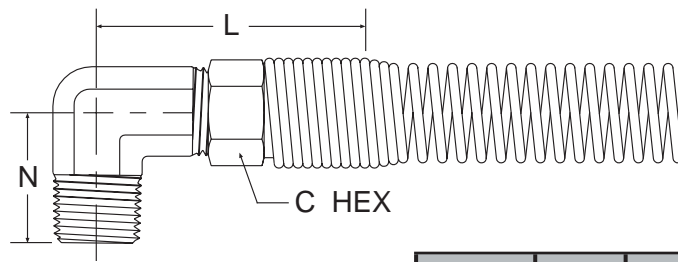

Part Number	Hose I.D.	End Type	End Size	L	N	C Hex	Box Quantity
#							
ME-03-4	3/16	90° Male Elbow	1/4 MPT	1-1/4	15/16	9/16	20
ME-04-4	1/4	90° Male Elbow	1/4 MPT	1-13/16	15/16	9/16	20
ME-06-6	3/8	90° Male Elbow	3/8 MPT	1-9/16	1-1/8	13/16	20
ME-08-8	1/2	90° Male Elbow	1/2 MPT	1-3/4	1-3/8	15/16	20

ML - Live Male Pipe Swivel

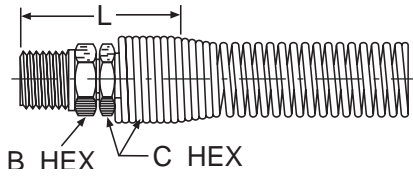

Part Number	Hose I.D.	End Type	End Size	L	B Hex	C Hex	Box Quantity
#							
ML-03-4	3/16	MPT Live Swivel	1/4 MPT	1-1/16	9/16	1/2	20
ML-04-4	1/4	MPT Live Swivel	1/4 MPT	1-9/16	9/16	9/16	20
ML-06-6	3/8	MPT Live Swivel	3/8 MPT	1-7/8	3/4	13/16	20
ML-08-8	1/2	MPT Live Swivel	1/2 MPT	2-3/8	7/8	15/16	20

FC Female Connector

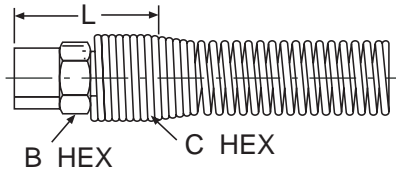

Part Number	Hose I.D.	End Type	End Size	L	B Hex	C Hex	Box Quantity
#							
FC-04-4	1/4	Female Pipe FPT	1/4 FPT	1-9/16	11/16	9/16	10
FC-06-6	3/8	Female Pipe FPT	3/8 FPT	1-3/4	13/15	13/16	10

FL - *Female Pipe Swivel

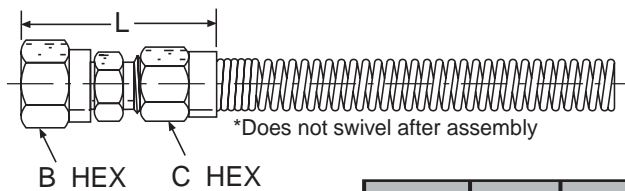

Part Number	Hose I.D.	End Type	End Size	L	B Hex	C Hex	Box Quantity
#							
FL-04-4	1/4	Female NPSM 30° Swivel	1/4 NPSM	1-3/4	5/8	9/16	20
FL-06-6	3/8	Female NPSM 30° Swivel	3/8 NPSM	2-1/8	3/4	9/16	10

*Does not swivel after assembly

UC Union Connector

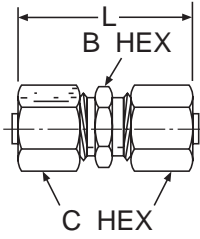

Part Number	Hose I.D.	End Type	End Size	L	B Hex	C Hex	Box Quantity
#							
UC-04-4	1/4	Union Connector	1/4 x 1/4 I. D. Hose	1-7/8	1/2	9/16	10
UC-06-6	3/8	Union Connector	3/8 x 3/8 I. D. Hose	2-5/8	11/16	13/16	10

Replacement Parts

FN - Brass Nut

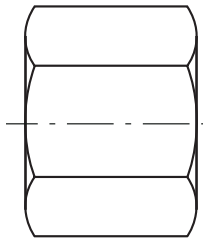

Part Number	Hose I.D.	Box Quantity
#		
FN-03	3/16	20
FN-04	1/4	20
FN-06	3/8	20
FN-08	1/2	20
FN-12	3/4	10

FR - Plastic Ferrule

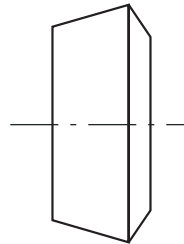

Part Number	Hose I.D.	Box Quantity
#		
FR-03	3/16	50
FR-04	1/4	50
FR-06	3/8	30
FR-08	1/2	20
FR-12*	3/4	10

*Available in brass only

SG - Steel Spring Guard

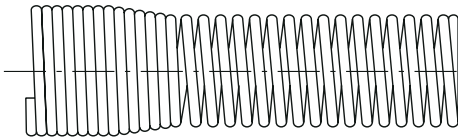

Part Number	Hose I.D.	Box Quantity
#		
SG-03	3/16	20
SG-04	1/4	20
SG-06	3/8	20
SG-08	1/2	20

TS - Tube Support

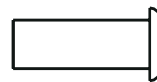

Part Number	Hose I.D.	Box Quantity
#		
TS-03	3/16	100
TS-04	1/4	100
TS-06	3/8	100
TS-08	1/2	100
TS-12	3/4	100

Size Selection Procedure

Proper size selection is extremely important in choosing any air hose in order to prevent "starvation" of the air tool, and to insure maximum torque and tool speed. Starved tools don't produce!

Steps in size selection:

1. Determine air flow rate and pressure required by following air-tool manufacturers recommendations.
2. Refer to "Air Flow Characteristics" Graphs, shown at right. Find air flow requirement in standard cubic feet per minute (SCFM) on vertical line to left of graph. Now follow horizontal line on same graph to determine total extended length of hose required. Follow vertical line above hose length to intersection with the horizontal air flow SCFM line.
3. Note pressure drop above curve nearest to intersection of SCFM and hose length lines. Pressure drop, subtracted from line pressure, equals "available pressure" at the selected SCFM flow rate and hose length.
4. If "available pressure" is below the tool manufacturers' recommendations, refer to chart for successively larger hose sizes until an acceptable "available pressure" is found. Choose this size Fast-Stor® Air Hose for your application.
5. Refer to "working pressure vs. temperature" chart to be sure your application falls within the working range of Fast-Stor® Air Hose.

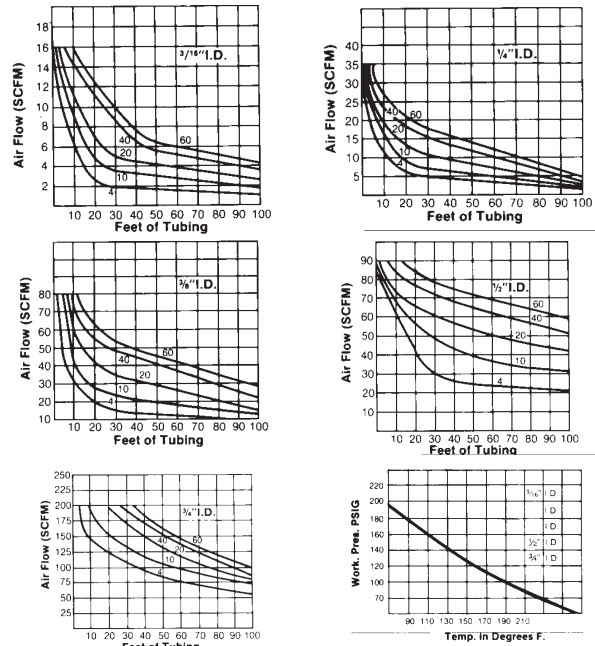

Typical Fast-Stor® Installation

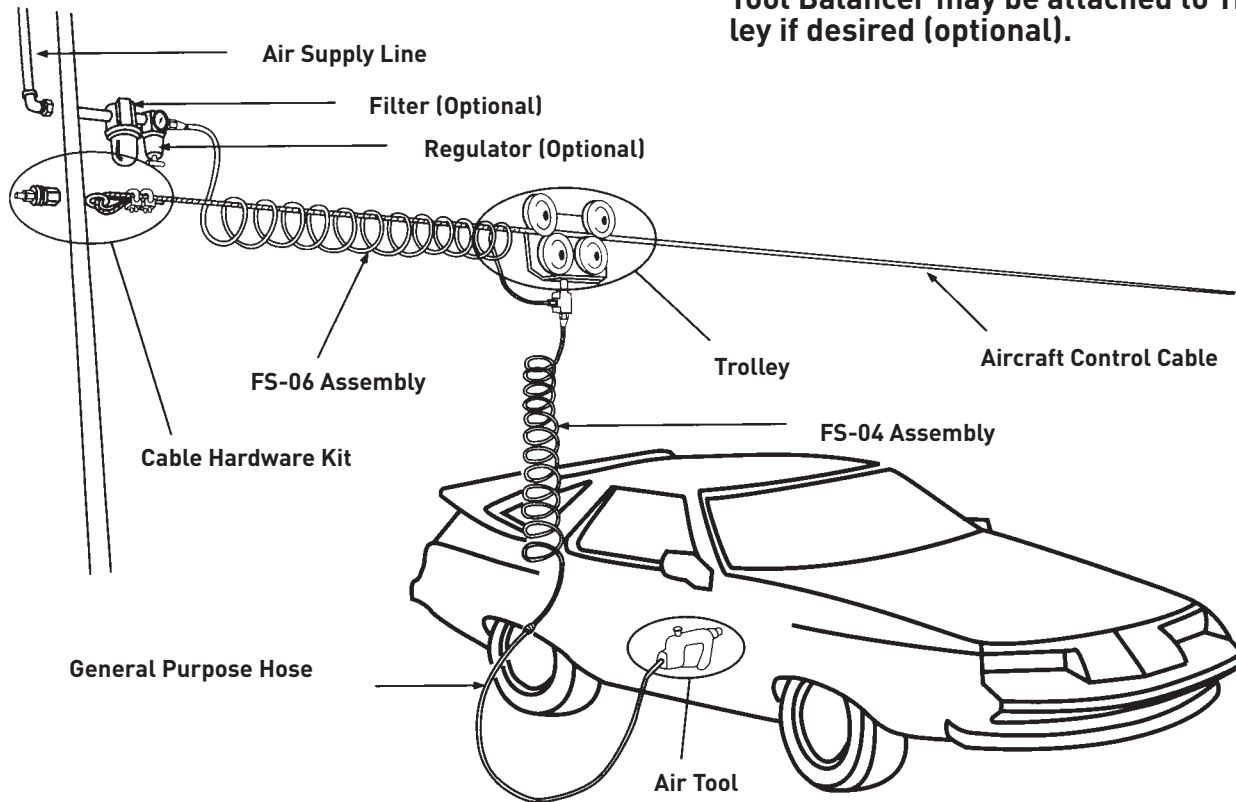

Air Line Lubricator and/or Reel Type Tool Balancer may be attached to Trolley if desired (optional).

Parflex NoMar™ Fast-Stor® Assemblies

How to order:

Urethane Fast-Stor® Assemblies

Includes live male end and rigid male end



Assembly Part Number	Hose O. D. in.	Hose I.D. in.	Working Length ft.	Coil I.D. in.	Max. Working Pressure PSI at 73°F	Min. Burst at 73°F	End Fittings
#							
AUFS-32-TBLU-010*	3/16	1/8	10	3/4	125	375	1/8" NPT
AUFS-32-TBLU-025*	3/16	1/8	25	3/4	125	375	1/8" NPT
AUFS-42-TBLU-010	1/4	1/8	10	3/4	125	375	1/4" NPT
AUFS-42-TBLU-025	1/4	1/8	25	3/4	125	375	1/4" NPT
AUFS-64-TBLU-010	3/8	1/4	10	1-1/4	125	375	1/4" NPT
AUFS-64-TBLU-015	3/8	1/4	15	1-1/4	125	375	1/4" NPT
AUFS-64-TBLU-020	3/8	1/4	20	1-1/4	125	375	1/4" NPT
AUFS-64-TBLU-025	3/8	1/4	25	1-1/4	125	375	1/4" NPT
AUFS-85-TBLU-010	1/2	21/64	10	2-1/2	125	375	3/8" NPT
AUFS-85-TBLU-015	1/2	21/64	15	2-1/2	125	375	3/8" NPT
AUFS-85-TBLU-020	1/2	21/64	20	2-1/2	125	375	3/8" NPT
AUFS-85-TBLU-025	1/2	21/64	25	2-1/2	125	375	3/8" NPT
AUFS-86-TBLU-010	1/2	3/8	10	2-1/2	85	255	3/8" NPT
AUFS-86-TBLU-020	1/2	3/8	20	2-1/2	85	255	3/8" NPT
AUFS-96-TBLU-010	9/16	3/8	10	2-1/2	125	375	3/8" NPT
AUFS-96-TBLU-015	9/16	3/8	15	2-1/2	125	375	3/8" NPT
AUFS-96-TBLU-020	9/16	3/8	20	2-1/2	125	375	3/8" NPT
AUFS-96-TBLU-025	9/16	3/8	25	2-1/2	125	375	3/8" NPT
AUFS-128-TBLU-010+	3/4	1/2	10	3	125	375	1/2" NPT
AUFS-128-TBLU-015+	3/4	1/2	15	3	125	375	1/2" NPT
AUFS-128-TBLU-020+	3/4	1/2	20	3	125	375	1/2" NPT
AUFS-128-TBLU-025+	3/4	1/2	25	3	125	375	1/2" NPT

Pigtail Lengths - 16" swivel end, 8" rigid end. Size -32 comes standard with two rigid ends.

Standard color is transparent blue (-TBLU). Other sizes and colors available upon request. Consult factory.

*Assembly includes rigid male end on both ends; live male ends not available.

+Permanent crimped shell.

Part Number	Hose O.D. in.	Hose I.D. in.	Working Length ft.	Coil I.D. in.	Max Working Pressure PSI at 73°F	Min Burst Pressure PSI at 73°F	End Fittings
#							
AHUF6-6-XXX-005	3/8	1/4	5	1-1/4	180	540	1/4" NPT
AHUF6-6-XXX-010	3/8	1/4	10	1-1/4	180	540	1/4" NPT
AHUF6-6-XXX-015	3/8	1/4	15	1-1/4	180	540	1/4" NPT
AHUF6-6-XXX-020	3/8	1/4	20	1-1/4	180	540	1/4" NPT
AHUF6-6-XXX-025	3/8	1/4	25	1-1/4	180	540	1/4" NPT

XXX- Color code for coils. Standard colors are: Black (BLK), Blue (BLU), Red (RED), Yellow (YEL)

Other sizes and colors available upon request. Consult factory

Parflex NoMar™ Fast-Stor®

Pigtail Lengths – 16" End #1, 8" End #2
 Standard color is transparent blue (-TBLU).
 Other sizes and colors available upon request.
 Consult factory.



Assembly Part Number	Hose O. D. in.	Hose I. D. in.	Working Length ft.	Coil I. D. in.	Max. Working Pressure PSI at 73°F	Min. Burst PSI at 73°F
#						
UFS-32-TBLU-010	3/16	1/8	10	3/4	125	375
UFS-32-TBLU-025	3/16	1/8	25	3/4	125	375
UFS-42-TBLU-010	1/4	1/8	10	3/4	125	375
UFS-42-TBLU-025	1/4	1/8	25	3/4	125	375
UFS-64-TBLU-010	3/8	1/4	10	1-1/4	125	375
UFS-64-TBLU-015	3/8	1/4	15	1-1/4	125	375
UFS-64-TBLU-020	3/8	1/4	20	1-1/4	125	375
UFS-64-TBLU-025	3/8	1/4	25	1-1/4	125	375
UFS-85-TBLU-010	1/2	21/64	10	2-1/2	125	375
UFS-85-TBLU-015	1/2	21/64	15	2-1/2	125	375
UFS-85-TBLU-020	1/2	21/64	20	2-1/2	125	375
UFS-85-TBLU-025	1/2	21/64	25	2-1/2	125	375
UFS-86-TBLU-010	1/2	3/8	10	2-1/2	85	255
UFS-86-TBLU-020	1/2	3/8	20	2-1/2	85	255
UFS-96-TBLU-010	9/16	3/8	10	2-1/2	125	375
UFS-96-TBLU-015	9/16	3/8	15	2-1/2	125	375
UFS-96-TBLU-020	9/16	3/8	20	2-1/2	125	375
UFS-128-TBLU-010	3/4	1/2	10	3	125	375
UFS-128-TBLU-015	3/4	1/2	15	3	125	375
UFS-128-TBLU-020	3/4	1/2	20	3	125	375
UFS-128-TBLU-025	3/4	1/2	25	3	125	375

Dimensions in inches.

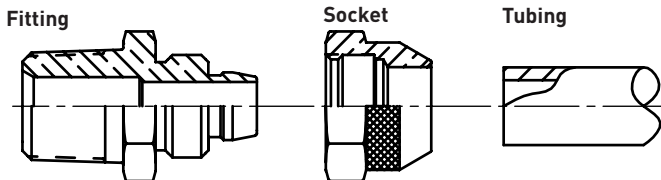

Assembly Instructions

1. Slide the socket on the tubing with threads facing the end of the tubing.
2. Press the tubing over the Tube Support portion of the fitting until the tube bottoms out. Do not use a lubricant.
3. Push the socket up to meet the mating threads on the fitting, finger tighten the socket onto the fitting.
4. Tighten the fitting and socket until the fitting hex and socket hex meet.

Hydraulic & Pneumatic Hose & Fit.

PTFE Hose & Fittings

Thermoplastic Tubing

Coiled Air Hose, Fittings & Accessories

Truck (Fleet) Products

Tooling & Equipment

Hose Accessories

Technical & Design Information

Approvals & Guides

Alphanumeric Index

Fittings Male Pipe Rigid

Parflex NoMar Polyurethane Fast-Stor® fittings are manufactured from a heavy brass construction utilizing all standards NPTF pipe threads. The engineered barb design generates the maximum gripping and sealing power when combined with the socket.

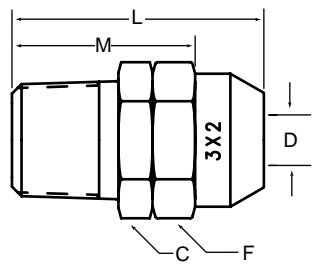

Part Number	Hose Part Number	Thread Size	L	M Cutoff	D I. D.	C Hex	F Hex
#	#						
MCB-3x2-2	UFS-32	1/8 NPT	0.94	0.72	0.11	7/16	7/16
MCB-4x2-2	UFS-42	1/8 NPT	1.00	0.74	0.12	7/16	7/16
MCB-4x2-4	UFS-42	1/4 NPT	1.16	0.90	0.12	9/16	7/16
MCB-6x4-4	UFS-64	1/4 NPT	1.16	0.90	0.23	5/8	5/8
MCB-6x4-6	UFS-64	3/8 NPT	1.20	0.94	0.23	3/4	5/8
MCB-8x5-6	UFS-85	3/8 NPT	1.29	0.99	0.27	3/4	3/4
MCB-8x6-4	UFS-86	1/4 NPT	1.29	1.03	0.28	3/4	3/4
MCB-8x6-6	UFS-86	3/8 NPT	1.30	1.04	0.34	3/4	3/4
MCB-9x6-6	UFS-96	3/8 NPT	1.47	1.10	0.31	7/8	7/8
MCB-9x6-8	UFS-96	1/2 NPT	1.61	1.24	0.32	7/8	7/8

For 3/4" size fitting offering, consult the factory for availability and assembly procedures.

Male Live Swivel

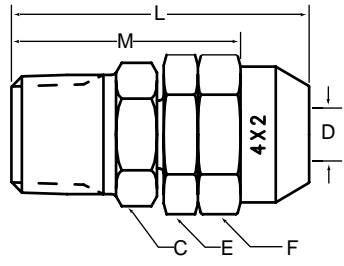

Part Number	Hose Part Number	Thread Size	L	M Cutoff	D I. D.	C Hex	E Hex	F Hex
#	#							
MLB-4x2-4	UFS-42	1/4 NPT	1.37	1.110	0.12	9/16	7/16	9/16
MLB-6x4-4	UFS-64	1/4 NPT	1.37	1.110	0.22	9/16	5/8	5/8
MLB-6x4-6	UFS-64	3/8 NPT	1.58	1.320	0.23	3/4	5/8	5/8
MLB-8x5-6	UFS-85	3/8 NPT	1.68	1.380	0.27	3/4	3/4	3/4
MLB-8x6-6	UFS-86	3/8 NPT	1.71	1.450	0.33	3/4	3/4	3/4
MLB-9x6-6	UFS-96	3/8 NPT	1.87	1.500	0.31	3/4	7/8	7/8
MLB-9x6-8	UFS-96	1/2 NPT	1.95	1.580	0.31	15/16	7/8	7/8

For 3/4" size fitting offering, consult the factory for availability and assembly procedures.



Truck (Fleet) Products

Visual Index.....207

Air Brake Tubing208

Parflex Diesel Fuel Tubing.....209

HTFL High Temperature Diesel Fuel Line Tubing.....209

BRAKCOIL®210

Duo-Coil™211

DollyCoil™.....212

Fifth Wheel Slider Coil.....212

SliderCoil™213

Harness & Bundles.....214

Truck (Fleet) Products Visual Index

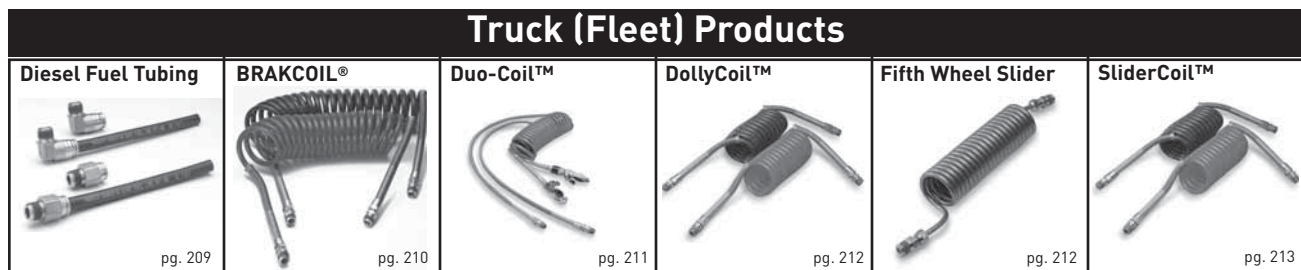

Air Brake Tubing

Parflex Tubing – Nylon tubing designed for use in tractor, trailer and other mobile air brake, instrumentation and air accessory systems. Meets SAE specification J844 Type A or B, D.O.T. FMVSS106, and performance requirements as specified in SAE specification J1131.

- 100% quality controlled – 100% pressure tested.
- Saves weight and labor in comparison with copper tubing.
- Heat and light stabilized.
- Colors available: Black, red, blue, green, orange, yellow, brown, silver, purple, white.

PFT Type A



Heat and light stabilized seamless single wall extruded nylon tubing, available in sizes 1/8 [-2], 5/32 [-2.5], 3/16 [-3], 1/4 [-4] and 5/16 [-5].

This tubing conforms to SAE specification J844 type A. The A refers to nonreinforced tubing.

Temperature Range: -40°F to +200°F [-40°C to +93°C].

Maximum Working Pressure: 150 PSI.

Meets D.O.T. FMVSS 106 (Sizes 2 and 2.5 not listed in FMVSS 106).

PFT Type B



Heat and light stabilized seamless extruded nylon core reinforced with one open ply of fibrous reinforcement and a protective nylon cover sheath. The outer cover and core are fused to minimize leakage and maximize impact resistance and are always of contrasting colors.

This tubing conforms to SAE specification J844 type B. The B refers to reinforced tubing.

Temperature Range: -40°F to +200°F [-40°C to +93°C].

-70°F to +200°F [-56.6°C to +93°C] for PFT-8B coiled air brake tubing.

Maximum Working Pressure: 150 PSI.

Meets D.O.T. FMVSS 106.

Tubing Type	Part Number	Std. Reel Length ft.	Nom. Tube O. D. in.	Nom. Tube I. D. in.	Nom. Wall Thick in.	Min. Bend Radius in.	Min. Burst Pressure at 75°F PSI	Weight lbs. Per 100 ft.
	#							
A	PFT-2A	1000	1/8	.079	.023	3/8	1000	.34
A	PFT-2.5A	250	5/32	.092	.032	1/2	1200	.57
A	PFT-3A	1000	3/16	.118	.035	3/4	1200	.77
A	PFT-4A	1000	1/4	.170	.040	1	1200	1.21
A	PFT-5A	500	5/16	.232	.040	1-1/4	1000	1.57
B	PFT-6B	500	3/8	.251	.062	1-1/2	1400	2.71
B	PFT-8B	500	1/2	.376	.062	2	950	3.89
B	PFT-10B	250	5/8	.441	.092	2-1/2	900	7.04
B	PFT-12B	250	3/4	.566	.092	3	800	8.57

Air Brake Fittings

NTA, push-in, and AB brass all available from:
Parker Brass Products Division
Otsego, Michigan
(616) 694-9411

Parflex Diesel Fuel Tubing

Parflex FL Tubing – Nylon tubing designed for use in tractor, trailer and other mobile fuel systems.

- Heat and light stabilized.
- 100% quality controlled – 100% pressure tested.
- Saves weight and labor in comparison with hose and hardline tubing.
- For use in D.O.T. diesel fuel applications.
- For use with Parker Prestomatic diesel fuel fittings.
- **Do not exceed temperature and pressure ranges.**

Diesel Fuel Tubing



Heat and light stabilized seamless extruded nylon core reinforced with fibrous reinforcement and bonded with a protective blue nylon cover sheath.

Temperature Range: -40°F to +200°F (-40°C to +93°C).

Maximum Working Pressure: 150 PSI.

Contact Parflex Division for application review.



Part Number	Reel Length ft.	Nom. Tube O. D. in.	Nom. Tube I. D. in.	Min. Bend Radius in.	Weight lbs. Per 100 ft.
#					
PFT-4A-XXX-1000-FL	1000	1/4	.170	1.00	1.21
PFT-6B-XXX-500-FL	500	3/8	.251	1-1/2	2.71
PFT-8B-XXX-500-FL	500	1/2	.376	2	3.89
PFT-10B-XXX-250-FL	250	5/8	.441	2-1/2	7.04
PFT-12B-XXX-250-FL	250	3/4	.566	3	8.57

XXX represents color code.
Standard color: blue (BLU).
Consult Division for additional colors.

HTFL High Temperature Diesel Fuel Line Tubing

Part Number	Nom. Tube O. D. in.	Nom. Tube I. D. in.	Nom. Wall Thickness	Max. Working Pressure at 73°F PSI	Min. Burst Pressure at 73°F PSI	Min. Burst Pressure at 266°F PSI	Min. Bend Radius in.	Weight lbs. Per 100 ft.	Reel Length ft.
#									
HTFL-6B-BRN-500	3/8	.251	.062	175	1,400	700	1-1/2	2.75	500
HTFL-8B-BRN-500	1/2	.376	.062	155	950	625	2	3.87	500
HTFL-10B-BRN-250	5/8	.441	.092	140	900	560	2-7/8	7.12	250
HTFL-12B-BRN-250	3/4	.566	.092	150	1,300	350	3	8.60	250

Tube: High temperature and chemical resistant special polyamide
Reinforcement: High strength yarn fiber
Cover: High temperature and UV resistant special polyamide

Cover Color: Brown (other colors, contact Parflex)
Temperature Range: -50°F to +266°F (-46°C to +130°C)
Vacuum Rating: 28 inches Hg
Fittings: *Parker NTA series brass compression fittings

* Available from the Parker Brass Products Division



BRAKCOIL®

Tractor to Trailer Coiled Nylon Air-Brake Connections

You get it all with Parker BRAKCOIL® – designed for just about any tractor/trailer air-brake application you will need for trouble-free service on your rig.

Parker BRAKCOIL® offers you these other features and advantages:

- The best cold temperature warranty in the business.
- Years of city delivery and line haul testing.
- Maintenance-free performance.
- Heavy duty plated spring guards that are rust resistant for added protection.
- More coils offer you maximum working lengths.
- No need for pogo sticks or spring hangers.
- Color coding gives you mistake-free hook-ups – blue for service, red for emergency.
- **Temperature range:** Meets or exceeds SAE J844 and D.O.T. FMVSS 106 specifications at -40°F to +200°F. In addition, Parker has tested and approved this product for -70°F to +200°F.
- Wide selection of configurations to suit any rig connections needed.
- Extended BRAKCOIL® handle available, part No. 771164.

When you need to replace your air-brake line . . . get it all with Parker BRAKCOIL®.

How to Order:

BRAKCOIL® kits are supplied complete – **Parker pre-assembled**, with everything needed, including spring guards and male pipe NTA brass fittings, **ready to install**. Special pipe thread sealant is factory applied. No cutting or assembly necessary. Just attach the gladhand to either end. They are available in kits or as separate lines. A kit consists of both a red and blue tube assembly.



Kit Coil Number	Individual Coil Part Number	Tube O. D.	Valve Tail Length in.	Brass Male Ends (NPT)		Working Length	Number of Coils	Application
				Valve	Gladhand			
#	#							
731516	731512-Red 731512-Blue	-8	12	1/2	1/2	15'	21-1/2	Tractor to Trailer
751597	731611-Red 731611-Blue	-8	12	3/8	1/2	15'	21-1/2	Tractor to Trailer
731522	731513-Red 731513-Blue	-8	40	1/2	1/2	15'	21-1/2	Tractor to Trailer
741526	731612-Red 731612-Blue	-8	40	3/8	1/2	15'	21-1/2	Tractor to Trailer
751641	741590-Red 741590-Blue	-8	6	1/2	1/2	12'	18-1/2	Tractor to Trailer
751655	751656-Blk Black Only	-8	6	3/8	1/2	12'	18-1/2	Tractor to Trailer
Fifth Wheel Slider	811537	-4	—	—	—	54"	—	Fifth Wheel Slider Coil

Duo-Coil™ Features

Newly designed Parker Duo-Coil combines both tractor-to-trailer lines (service and emergency) into a strong single unit. The specially designed Duo-Coil will provide years of trouble-free service.

Parker Duo-Coil has built in the following features:

- Reverse winding of the coiled air brake lines eliminates the possibility of tangling.
- Installation swivel fittings make hook-up a snap.
- The inner red emergency coil is wound inside the blue service coil offering added protection to the driver.
- The single unit provides clean and neat installation.
- Parker product testing for -70°F to +200°F provides performance confidence at low temperatures as well as the best cold temperature warranty in the business.

Application

The right connection for quick, trouble-free hook-up between your tractor and trailer. Whether it's an extended trailer with outboard valve ports on the chassis or high or low air ports on the cab, Parker Duo-Coil has the right configuration for your rig.*

- * Parker Duo-Coil assemblies fully comply with D.O.T. requirements covering coiled nylon brake tubing as stated in Chapter III— Federal Highway Administration, Department of Transportation, Subchapter B – Motor Carrier Safety Regulations (Docket No. MC-41; Notice No. 73-9), Part 393—Parts and Accessories Necessary for Safe Operation.

How to Order:

Duo-Coil kits are supplied complete—**Parker pre-assembled**, with everything needed, including spring guards and pipe end NTA fittings, **ready to install**. Special pipe thread sealant is factory applied. No cutting or fitting assembly is necessary. Just attach the gladhand to either end. Nylon tubing used in Duo-Coil conforms to SAE J844d (Revision c), Type 3B (3B refers to reinforced tubing).



Note: Gladhands not supplied.

Kit Coil Number	Tube O. D.	Valve Tail	Brass Male Ends (NPT)		Working Length ft.	Number of Coils
			Valve	Gladhand		
#						
801048	-8	12	1/2	1/2	15	21-1/2
801632	-8	6	1/2	1/2	12	18-1/2
801595	-8	40	1/2	1/2	15	21-1/2

For information on additional truck and trailer products, call or write for the Parker Fleet Products Catalog 4453.



Hydraulic & Pneumatic Hose & Fit.

PTFE Hose & Fittings

Thermoplastic Tubing

Coiled Air Hose, Fittings & Accessories

Truck (Fleet) Products

Tooling & Equipment

Hose Accessories

Technical & Design Information

Approvals & Guides

Alphanumeric Index

DollyCoil™

The Parker DollyCoil is used between double trailers on converter dollies. No need to install springs or hangers as DollyCoil will retract to its original shape time and time again – even after long periods of extended use. Standard working lengths are 6 feet. Parker DollyCoil assemblies fully comply with D.O.T. requirements covering coiled nylon brake tubing as stated in Chapter III – Federal Highway Administration, Department of Transportation, Subchapter B – Motor Carrier Safety Regulations (Docket No. MC-41; Notice No. 73-9), Part 393 – Parts and Accessories Necessary for Safe Operation.



How to Order:

DollyCoil kits are supplied complete – **Parker pre-assembled**, with everything needed, including spring guards and male pipe end NTA fittings, **ready to install**. Special pipe thread sealant is factory applied. No cutting or assembly necessary. Just attach the gladhand to either end. They are available in kits or as separate lines. A kit consists of both a red and blue tube assembly.

Kit Coil Number	Tube O. D.	Valve Tail	Brass Male Ends (NPT)		Working Length Range ft.	Number of Coils	Application	Color
			Valve 90° End	Gladhand 180° End				
#								
751634	-8	8	1/2	1/2	6	12	Convert, Dollies	Blue, Red

Fifth Wheel Slider Coil

- Clutter-free hook-up and maintenance-free performance of adjustable length pneumatic tubing for fifth wheel sliding action.
- Returns to its original shape time after time, even after long periods of extended use.
- Self-adjusts from 10" to fully extended 54" working length.
- Universal, ready for immediate installation.

No Maintenance: Slider coil will stay on the job at peak performance through years of trouble-free life.

Self-Adjusting: Coil set is strong and permanent. Even after prolonged use in fully extended position, coils will retract to shorter length without sagging. Eliminates hazards of chafing and wear.



Note: Fitting assembly required.

Technical Data

Construction: A heat and light stabilized single wall 1/4" O.D. extruded nylon tubing conforming to SAE specification J844 type A.

Temperature Range: -40°F to +200°F (-40°C to +93°C)

Maximum Working Pressure: 150 PSI, meets D.O.T. FMVSS 106 standard.

Part Number	Fittings	Pigtail Length in.	Max. Extended Length in.	Retracted Length in.
#				
811537	{2}68NTA-4-4	2	54	10

SliderCoil™

The Parker SliderCoil is used between an adjustable rear trailer axle and the final point on a trailer chassis. No need to install springs or hangers. SliderCoil will retract to its original shape even after long periods of extended use. Standard working length is 6 to 8 feet. It meets all D.O.T. requirements – Title 49, – Transportation Chapter III, – Federal Highway Administration, – D.O.T. [Docket No. MC-68; Notice No. 75-16], Part 393, Parts and Accessories Necessary for Safe Operation.



How to Order:

SliderCoil kits are supplied complete – **Parker pre-assembled**, with everything needed, including spring guards and male pipe end NTA fittings, **ready to install**. Special pipe thread sealant is factory applied. No cutting or assembly necessary. Just attach the gladhand to either end. They are available in kits or as separate lines. A kit consists of both a red and blue tube assembly.

Kit Coil Number	Individual Coil Part Numbers	Tube O. D.	Valve Tail	Brass Male Ends (NPT)		Working Length Range ft.	Number of Coils	Application	Color
				Valve 90° End	Gladhand 180° End				
#	#								
751657	751658-BLU, RED	-8	8	1/4	1/4	14-1/2	6' - 8'	Sliding	Blue, Red
751659	751660-BLU, RED	-8	8	3/8	3/8	14-1/2	6' - 8'	Trailer Axles	Blue, Red

Hydraulic & Pneumatic Hose & Fit.

PTFE Hose & Fittings

Thermoplastic Tubing

Coiled Air Hose, Fittings & Accessories

Truck (Fleet) Products

Tooling & Equipment

Hose Accessories

Technical & Design Information

Approvals & Guides

Alphanumeric Index

Harness & Bundles

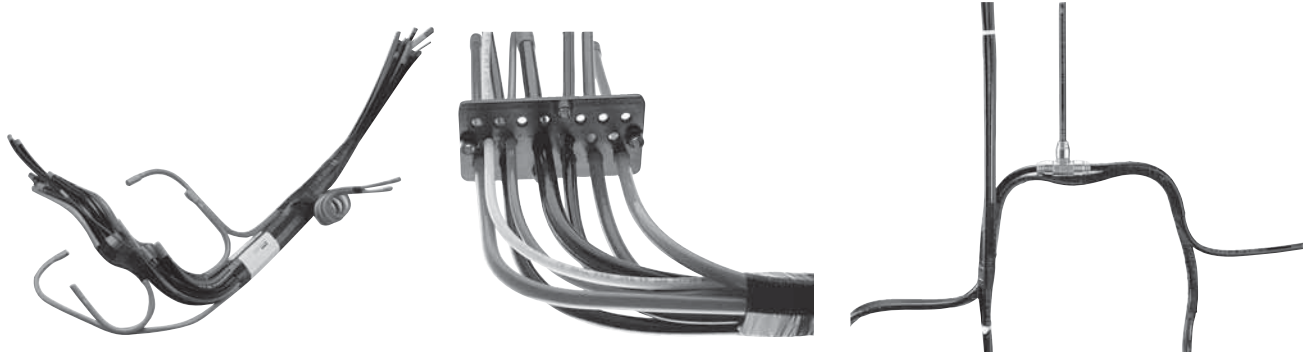

Application

Preformed, prebundled tubing or hose custom designed to reduce installation time and improve throughput.

Features

With Parker Parflex Tubing Harnesses, your production line will run faster, and be virtually free from tubing scrap.

Parker Parflex Tubing Harnesses combine all of the advantages found in Parker Air Brake Tubing with those of the electrical harnesses used today in the transit bus and heavy-duty truck market. They are designed and engineered to meet the exacting requirements of each bus or truck manufacturer for each vehicle.

Advantages

- Individual tubes are pre-cut and assembled into a single unit.
- Each tube can be color coded and/or numbered.
- Each harness may contain any number of tube sizes ranging from 1/8" O. D. to 3/4" O. D.
- The harness can be supplied with special clamps, brackets, and fittings to meet any need required by the customer.
- The air brake tubing used in a Parflex Harness conforms to SAE J844 type 3A and 3B and also D.O.T. FMVSS 106.

Several different harnesses may be required on a single unit depending upon the model of the vehicle, wheel base, and options available. To determine your harness application needs:

1. Recognize the cost savings available to you through the use of harnesses. How many dollars will be saved on tubing installation alone? On scrap reduction?
2. Call Parker. Have one of our application engineers study your applications.
3. Have our engineer design and build a prototype harness for your approval.
4. Approve the prototype as our basis to engineer your production model harness.
5. Implement the harness into your Purchasing and Production systems – one harness, one part number instead of multiple part numbers you once had for each air brake line.

Benefit

Your production line, now using a Parker Parflex Harness, will be neater – installation time and tube scrap will be kept to a minimum. Accuracy and ease of installation will be improved dramatically.

Join the many other truck and bus manufacturers who are already taking advantage of the benefits offered by incorporating Parker Parflex Tubing Harnesses into their systems.

Hydraulic & Pneumatic Hose & Fit.

PTFE Hose & Fittings

Thermoplastic Tubing

Coiled Air Hose, Fittings & Accessories

Truck (Fleet) Products

Tooling & Equipment

Hose Accessories

Technical & Design Information

Approvals & Guides

Alphanumeric Index

Tooling & Equipment

Visual Index216

Minute Machine PMM-1 Hand Swager217

SQ-101-SW Swager/Mender217

Swager Tooling217

HTC Hose & Tubing Cutter.....217

MiniKrimp 218-221

Karrykrimp.....222

Karrykrimp II.....222

Parkrimp I222

Parkrimp II.....222

Superkrimp222

Parflex Pumps (for use with Karykrimp).....223

Air Over Hydraulic Pump (for use with MiniKrimp™).....223

Parflex Parkrimp Die Identification224

ENERPAC Warranty Policy.....225

Cutoff Tools226

Vise Blocks.....226

Hozemblem.....226

Hydraulic &
Pneumatic
Hose & Fit.

PTFE
Hose &
Fittings

Thermoplastic
Tubing

Coiled Air Hose,
Fittings
& Accessories

Truck (Fleet)
Products















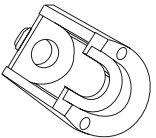







Tooling &
Equipment

Hose
Accessories

Technical &
Design
Information

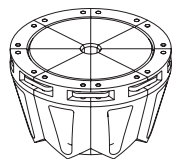
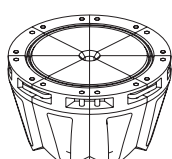
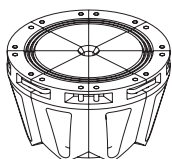
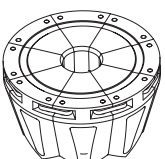
Approvals &
Guides

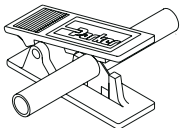
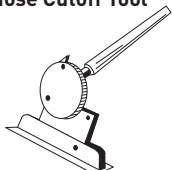
Alphanumeric
Index

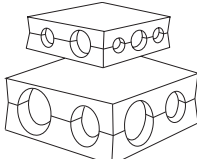
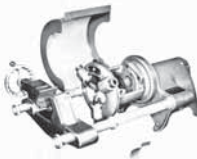
Tooling & Equipment					
Swagers, Swager Tooling	Minute Machine PMM-1 Hand Swager  pg. 217	SQ-101-SW Swager/Mender  pg. 217	Male Pushers  pg. 247	Female Pushers  pg. 217	Tube Pushers  pg. 217
Split Dies  pg. 217	HTC Cutter  pg. 217	MiniKrimp™	Hand Pump Model  pg. 218	Air Over Hydraulic  pg. 219	MiniKrimp Portable Stand  pg. 220
Karrykrimp	Karrykrimp  pg. 222	Karrykrimp II  pg. 222	Parkrimp	Parkrimp I  pg. 222	Parkrimp II  pg. 222
Superkrimp	Superkrimp  pg. 222	Pumps	Hand Pump  pg. 223	Hand Pump  pg. 223	Hand Pump  pg. 223
Air-Over-Hydraulic  pg. 223	Parflex Parkrimp Dies	1 Groove  55 pg. 224	2 Grooves  58 pg. 224	3 Grooves  91N, 92 pg. 224	1 V Groove  HY pg. 224
Cutoff Tools	Hose Cutoff Machine  pg. 226	Plastic Tube Cutter  pg. 226	Hose Cutoff Tool  pg. 226	Karrykut  pg. 226	Vise Blocks
Vise Blocks  pg. 226	Hozemblem	Hozemblem  pg. 226			

Parflex Minute Machine PMM-1 Hand Swager

Operated with ordinary 1-1/2 open end or box wrench (not included).

Interchangeable with other popular types of hand swaging tools.

Best of all, factory perfect assemblies with Parflex hose can be made anywhere in the field by customers otherwise unfamiliar with ordinary rubber hose assembly procedures.

* Wrench part number: 821072



SQ-101-SW Swager/Mender

Used for field assembly or repair on Predator S6 and S9 hoses

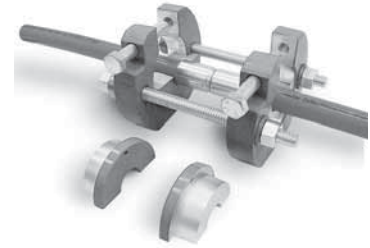

Swager Tooling

(Sizes given in fittings section)

Male Pushers

See Fittings Section for correct PUM part number.

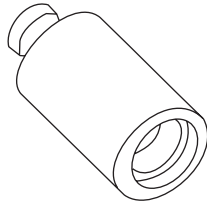

Tube Pushers

See Fittings Section for correct PUT part number.

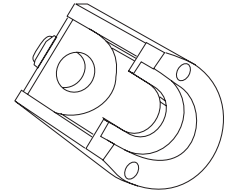

Female Pushers

See Fittings Section for correct PUF & PUL part number.

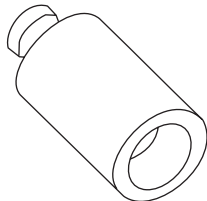

Split Dies

See Swage and Crimp Die Selection Chart for correct part number.

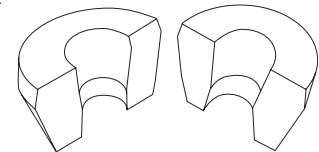

HTC Hose & Tubing Cutter

Features:

- Heavy duty steel construction & insulated grip
- Special V-block design & blade

Multiple capabilities:

- Up to 1" hose/tubing OD
- Non-wire reinforced thermoplastic hose & tubing
- Non-wire reinforced rubber hose & tubing

Advantages /Benefits:

- Durable & portable; weighs only 12 ounces
- Ensures a straight, clean cut
- Cutting edge first punctures, then cuts
- Minimal flattening of hose /tubing during cutting
- Straight/square cut enhances fitting retention
- Easily adjustable blade provides two cutting surfaces- doubles blade life
- Versatile; one tool for multiple applications- Air tools, auto repair shops, beverage dispensers, laboratories, many general industrial and commercial applications
- Replacement blade: HTC-RB

Hydraulic & Pneumatic Hose & Fit.

PTFE Hose & Fittings

Thermoplastic Tubing

Coiled Air Hose, Fittings & Accessories

Truck (Fleet) Products

Tooling & Equipment

Hose Accessories

Technical & Design Information

Approvals & Guides

Alphanumeric Index

MiniKrimp™—Hand Pump Model

Specifications

Approximate Size (with Pump)	6" Deep, 13" Wide, 15" High
Weight	42lbs. with hand pump
Rating	30 tons force @ 10,000psi maximum



Standard Equipment

Model 94C-001-PFD includes:

Part Description	Part Number
MiniKrimp™ Portable Crimping Machine	94C-080-PFD
Hand Pump	015301
Die Ring — Color Coded Silver	82C-R01-PFD

The Parker Hannifin MiniKrimp™ is the best portable crimper on the market. Its' unique construction holds three U.S. patents for design and utility. By utilizing a one-piece, high strength cast aluminum frame, the MiniKrimp is light, robust, and highly corrosion resistant. At 10,000psi and 30+ tons of force the MiniKrimp can crimp the majority of Parker thermoplastic, rubber, hybrid, PTFE and specialty hoses up to 1" ID. Exceptions do occur depending on the hose type, hose size, and fitting material. It is suggested that several trials be performed using the proposed hose and fitting combination in order to confirm a successful crimp. Set up and cycle times can also be determined by performing a crimp trial. Cycle times will vary depending on the previously mentioned variables in addition to the hydraulic pump used. Additional hydraulic pumps are listed for support in the Parker catalogs 4660 or 4400. If a trial is not possible, contact the Parker hose manufacturing division for support.

For crimp information on your particular hose and fitting combination refer to CrimpSource Online or the appropriate catalog of the Parker division that supplies the hose.

www.parker.com/fcg

www.parker.com/dayco/csonline/crimpsource.asp

All pumps are supplied to Parker by Enerpac. For repair or warranty work to any of the cylinders or pumps, contact your nearest Enerpac Service Center. For the Enerpac Service Center nearest you, call 1-800-558-0530 or visit the Enerpac web site at www.Enerpac.com.

MiniKrimp™ — Air-Over-Hydraulic Model



Specifications

Approximate Size (with Pump)	6" Deep, 12" Wide, 15" High
Weight	45lbs. with air/hydraulic pump
Rating	30 tons force @ 10,000psi maximum

Standard Equipment

Model 94C-002-PFD includes:

Part Description	Part Number
MiniKrimp™ Portable Crimping Machine	94C-080-PFD
Air-Over-Hydraulic Pump (includes tubing and adapters)	025399
Die Ring — Color Coded Silver	82C-R01-PFD

The Parker Hannifin MiniKrimp™ is the best portable crimper on the market. Its' unique construction holds three U.S. patents for design and utility. By utilizing a one-piece, high strength cast aluminum frame, the MiniKrimp is light, robust, and highly corrosion resistant. At 10,000psi and 30+ tons of force the MiniKrimp can crimp the majority of Parker thermoplastic, rubber, hybrid, PTFE and specialty hoses up to 1" ID. Exceptions do occur depending on the hose type, hose size, and fitting material. It is suggested that several trials be performed using the proposed hose and fitting combination in order to confirm a successful crimp. Set up and cycle times can also be determined by performing a crimp trial. Cycle times will vary depending on the previously mentioned variables in addition to the hydraulic pump used. Additional hydraulic pumps are listed for support in the Parker catalogs 4660 or 4400. If a trial is not possible, contact the Parker hose manufacturing division for support.

For crimp information on your particular hose and fitting combination refer to CrimpSource Online or the appropriate catalog of the Parker division that supplies the hose.

www.parker.com/fcg

www.parker.com/dayco/csonline/crimpsource.asp

All pumps are supplied to Parker by Enerpac. For repair or warranty work to any of the cylinders or pumps, contact your nearest Enerpac Service Center. For the Enerpac Service Center nearest you, call 1-800-558-0530 or visit the Enerpac web site at www.Enerpac.com.

Hydraulic &
Pneumatic
Hose & Fit.

PTFE
Hose &
Fittings

Thermoplastic
Tubing

Coiled Air Hose,
Fittings
& Accessories

Truck (Fleet)
Products

Tooling &
Equipment

Hose
Accessories

Technical &
Design
Information

Approvals &
Guides

Alphanumeric
Index



Part #: 015307, Upright Vise Mount
Machined and bent from ¼ inch thick 1018 steel. The mount connects to the bottom of the MiniKrimp™ using four 3/8-16 bolts (bolts not included). Once connected, the MiniKrimp™ can then be clamped into a vise for operation. Top and side view shown.



Part #: 015306, Table Mount
Machined and bent from ¼ inch thick 1018 steel. The mount connects to the bottom of the MiniKrimp™ using four 3/8-16 bolts (bolts not included). The MiniKrimp™ can then be mounted to a table using the four 3/8 inch clearance holes on the other side of the plate (bolts not included). Top and side view shown.

Part #: 015309, High Pressure Hose Assembly
Parker 10,000 psi, ¼ inch ID hose with 3/8 inch female JIC connections on both ends. Hose is 6 feet long and is used when a flexible connection is required between the MiniKrimp and a hydraulic pressure source.

Part #: 015308, Replacement Connector
Replacement stainless steel bent tube rigid connector for 94C-001-PFD (MiniKrimp Hand Pump Model).

Part #: 025349, Replacement Connector
Replacement stainless steel bent tube rigid connector for 94C-002-PFD (MiniKrimp Air over Hydraulic Model).

Part #: 045234, High Pressure Hose Assembly for stand
Parker 10,000 psi ¼ inch ID hose with quick coupler. This hose is designed to be used when mounting a hand pump to the 94C-MKS MiniKrimp™ stand's base. See picture below.

Note: The hydraulic connectors shown above are designed exclusively for use with the MiniKrimp. No other connectors are approved for use with the MiniKrimp without expressed written consent from Parker Parflex Division's technical support. Any worn connectors should be replaced immediately.

MiniKrimp™ Crimping Machine



Part #: 94C-MKS, Folding Stand

The 94C-MKS is a lightweight folding stand designed exclusively for the MiniKrimp™ portable crimper (works with all versions). When not in use the stand folds up closely to the MiniKrimp™ for storage. Mounting hardware and safety instructions are included. See pictures below for configuration examples Patent pending



Hydraulic &
Pneumatic
Hose & Fit.

PTFE
Hose &
Fittings

Thermoplastic
Tubing

Coiled Air Hose,
Fittings
& Accessories

Truck (Fleet)
Products

Tooling &
Equipment

Hose
Accessories

Technical &
Design
Information

Approvals &
Guides

Alphanumeric
Index

Karrykrimp

Karrykrimp, with crimping capability up to 1-1/4", SAE 100R1, 100R2, 100R7, 100R8, 100R9 and 100R14, gives you true field-crimping capability. Utilizing Parker's patented unitized dies (the same as Parkrimp I and II), this lightweight machine is easily carried to the job site for quick, easy field assemblies — when downtime is critical. The Karrykrimp unit puts hose assembly fabrication where you need and want it, on the spot.

Part No.

82C-061-PFD Karrykrimp, two-piece stand, silver die ring, black die ring, connection hose with coupling, no dies, no pump

82C-R01-PFD Karrykrimp silver die ring



Karrykrimp II

Karrykrimp II is portable, compact and ruggedly built. The Karrykrimp II gives you everything you need to crimp hoses from 1/4" to 1-1/4" in one convenient package. Model 85C-061 includes crimping machine, collapsible stand, die rings, and connection hose with quick coupling. Select the power unit that meets your needs.

Part No.

85C-061-PFD Karrykrimp 2, two-piece stand, silver die ring, black die ring, connection hose with coupling, no dies, no pump

85C-R01-PFD Karrykrimp 2 silver die ring



Superkrimp

Superkrimp can handle all Parflex thermoplastic and TFE hose assemblies up through 2". Its design — with capacity to handle 100R7, 100R8, and 100R14 hose types, coupled with straight or bent tube ends — is the industry's leading edge in the manufacture of hose assemblies. Unparalleled in its design, Superkrimp needs no special adjustments or gauge settings. Simply insert the unitized or split die train for the appropriate size, and with push-button ease you have factory quality assemblies in just seconds.

- Bench top design
- Quick, easy operation
- Stainless steel crimping

Part No.

88C-082-PFD Superkrimp, 115/120 volt single phase power unit wired for 230 volts, adapter bowl, spacer ring, spacer plate, no dies. Order appropriate dies from the crimp die selection chart in the Technical & Design Information section.

Parkrimp I

Parkrimp I offers hose assembly capability through 1-1/4", SAE 100R1, 100R2, 100R7, 100R8, 100R9 and 100R14. Its patented design provides you with the ability to crimp straight — as well as bent tube hose ends; a full power return cycle allows quick, easy size and hose type changes, while the die pusher automatically moves out of the way for easy die insertion: Bench mounted at a 20° angle lets you load and unload hydraulic assemblies as easily as possible. Parkrimp I gives you the ease and flexibility to manufacture hydraulic hose assemblies you require — and in less than ten seconds.

Part No.

80C-081-PFD Parkrimp 1 crimper, silver die ring, black die ring, no dies

80C-R01-PFD Parkrimp 1 silver die ring



Parkrimp II

Parkrimp II provides you with total capability to manufacture hydraulic hose assemblies up through 2". Parkrimp II's advanced design — with capacity to handle 100R1 through 100R14 hose types, coupled with straight or bent tube ends — is the industry's leading edge in the manufacture of hydraulic hose assemblies. Unparalleled in its design, Parkrimp II needs no special adjustments or gauge settings. Simply insert the unitized or split die train for the appropriate size — and with push button ease you have factory-quality assemblies in just seconds.

Part No. 83C-081-PFD

.....Parkrimp 2 head assembly, Parkrimp 2 stand assembly with 230/460 volt 3 phase power unit wired for 230 volt, adapter bowl, spacer ring, no dies



Parflex Hand Pumps

Hand Pump

Part No. 015301 (for use with MiniKrimp™ Hand Pump Model)
Easy-to-use hand pump delivers 10,000 PSI.

Length 13-3/8"
 Width 3-1/4"
 Height 3-5/8"
 Port Size 1/4" NPTF
 Weight 4.7 lb.
 Hydraulic Fluid Enerpac Oil only



Hand Pump

Part No. 82C-0HP-PFD (for use with Karrykrimp, Karrykrimp II & MiniKrimp™)
Easy-to-use hand pump delivers 10,000 PSI.

Length 22-11/16"
 Width 3-1/4"
 Height 4-11/16"
 Port Size 3/8" NPTF
 Weight 9 lb.
 Hydraulic Fluid Enerpac Oil only



Hand Pump

Part No. 85C-0HP-PFD (for use with Karrykrimp, Karrykrimp 2 & MiniKrimp™)
Easy-to-use hand pump delivers 10,000 PSI.

Length 28-15/16"
 Width 2-1/8"
 Height 11"
 Port Size 3/8" NPTF
 Weight 61 lb.
 Hydraulic Fluid Enerpac Oil only

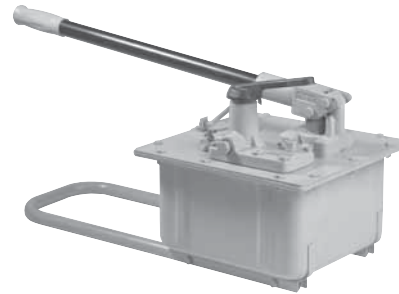

Air-Over-Hydraulic Pump

Part No. 025399 (for use with MiniKrimp™ Air-over-Hydraulic Model)
Lightweight pump operates with 80 - 120 PSI shop air pressure.

Length 13"
 Width 4-1/2"
 Height 5"
 Intake Port Size 1/4" NPTF
 Output Port Size 1/8" NPTF
 Weight 12 lb.
 Hydraulic Fluid Enerpac Oil only

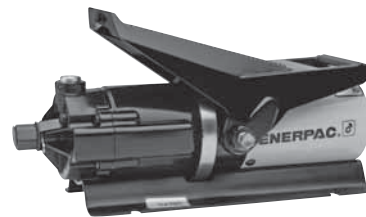

Reference Parker Hose Products Catalog 4400 for these additional pump options for use with Karrykrimp, Karrykrimp 2 & MiniKrimp™:

Pump Description	Part Number
Electric Pump	82C-OEP
Electric Pump	85C-OEP

All pumps are supplied to Parker by Enerpac. For repair or warranty work to any of the cylinders or pumps, contact your nearest Enerpac Service Center. For the Enerpac Service Center nearest you, call 1-800-558-0530 or visit the Enerpac web site at www.Enerpac.com.



Hydraulic & Pneumatic Hose & Fit.
 PTFE Hose & Fittings
 Thermoplastic Tubing
 Coiled Air Hose, Fittings & Accessories
 Truck (Fleet) Products
 Tooling & Equipment
 Hose Accessories
 Technical & Design Information
 Approvals & Guides
 Alphanumeric Index

Parflex Parkrimp Dies

Parkrimp dies, specifically engineered for thermoplastic and fluoropolymer hose:

- Linked die segments
- Pre-matched and assembled
- Fitting series identification grooves
- Fitting size color coded.

Note: Parflex dies have been designed for use with the silver die ring. Silver die rings are to be used with all Parflex hoses unless otherwise specified.

The following is a list of the silver die rings for the approved Parkrimp machines:

Parkrimp I and PHaskrimp - silver die ring part no. 80C-R01-PFD

Karrykrimp and MiniKrimp - silver die ring part no. 82C-R01-PFD

Karrykrimp 2 - silver die ring part no. 85C-R01-PFD

Parkrimp 2 and Superkrimp - silver die rings attached to unit. No additional silver die rings required.

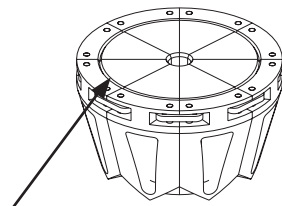

1 groove
55 series

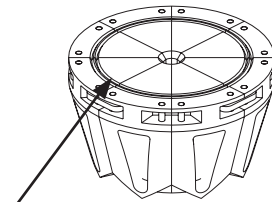

2 grooves
58 series

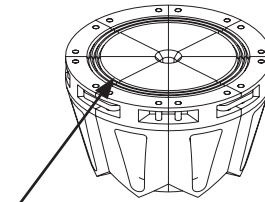

3 grooves
91N, 92 series

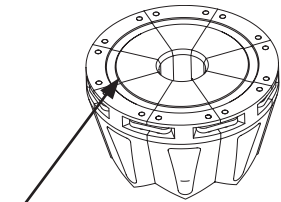

1 V groove
HY series

Color Code:

Size	Color
-2	Brown
-3	Gray
-4	Red
-5	Purple
-6	Yellow
-8	Blue
-10	Orange
-12	Green
-16	Black

Additional Notes:

- 1) The Parkrimp dies used with "HY" series fittings will have a groove of 3/16" wide with the part number stamped into the groove instead of the "C" groove commonly associated with Parflex crimp dies.
- 2) See Swage and Crimp Die Selection Chart in section "J" of this catalog for proper part number selection.

Visit CrimpSource Online at www.parker.com/dayco/csonline/crimpsource.asp for the latest and most up to date crimping information such as dies and crimp specification for all your favorite Parflex hoses.

ENERPAC Warranty Policy

For those ENERPAC items sold as part of the Parker Parflex Division product offering, the following warranty applies.

ENERPAC products are warranted to be free of defects in materials and workmanship under normal use for as long as they are owned by the original purchaser, subject to the exclusions and limitations described below. This warranty does not cover ordinary wear and tear, overloading, alterations, (including repairs or attempted repairs by parties other than ENERPAC or its authorized service representatives), improper fluid, use in a manner for which they are not intended or use which is contrary to instructions for the products.

THIS WARRANTY IS LIMITED TO NEW PRODUCTS SOLD THROUGH ENERPAC AUTHORIZED DISTRIBUTORS, ORIGINAL EQUIPMENT MANUFACTURERS OR OTHER DESIGNATED CHANNELS OF DISTRIBUTION. NO AGENT, EMPLOYEE, OR OTHER REPRESENTATIVE OF ENERPAC HAS THE AUTHORITY TO IN ANY WAY CHANGE OR AMEND THIS WARRANTY.

Electronic products and components are warranted against defects in material and workmanship for a period of two years from the date of purchase.

The following items supplied with ENERPAC products are excluded from this warranty:

- Components not manufactured by ENERPAC, including air motors, electric motors, gasoline engines, and diesel engines. Such items are warranted to the extent of the warranty provided by the manufacturers of such items.

If the customer believes a product is defective, the product must be delivered, or shipped freight prepaid, to the nearest ENERPAC Authorized Service Center. The customer should contact ENERPAC to locate and Authorized Service Center in the customer's area.

Products that do not conform to this warranty will be returned by ground transportation, freight prepaid.

THE FOREGOING WARRANT IS EXCLUSIVE AND IS IN LIEU OF ALL OTHER EXPRESS AND IMPLIED WARRANTIES, INCLUDING BUT NOT LIMITED TO THE IMPLIED WARRANTIES OF MERCHANTABILITY AND FITNESS FOR A PARTICULAR PURPOSE.

The remedy of repair, replacement or refund is customer's exclusive remedy in the event of breach of this warranty.

SELLER SHALL NOT BE SUBJECT TO AND DISCLAIMS:

- (a) ANY OTHER OBLIGATIONS OR LIABILITIES ARISING OUT OF BREACH OF CONTRACT OR OF WARRANTY,
- (b) ANY OBLIGATIONS WHATSOEVER ARISING FROM TORT CLAIMS (INCLUDING NEGLIGENCE AND STRICT LIABILITY) OR ARISING UNDER THEORIES OR LAW WITH RESPECT TO PRODUCTS SOLD OR SERVICES RENDERED BY SELLER OR ANY UNDERTAKINGS, ACTS OR OMISSIONS RELATING THERETO, AND
- (c) ALL CONSEQUENTIAL, INCIDENTAL AND CONTINGENT DAMAGES WHATSOEVER.

ENERPAC's liability in all cases is limited to, and shall not exceed, the purchase price paid.

For the nearest authorized ENERPAC SERVICE CENTER, please call ENERPAC at 1-800-558-0530 or visit the ENERPAC web site at www.Enerpac.com.

Hydraulic & Pneumatic Hose & Fit.

PTFE Hose & Fittings

Thermoplastic Tubing

Coiled Air Hose, Fittings & Accessories

Truck (Fleet) Products

Tooling & Equipment

Hose Accessories

Technical & Design Information

Approvals & Guides

Alphanumeric Index



Hose Cutoff Machine

- Power unit for quick, easy cutting of cotton or rubber covered fabric braid or wire reinforced hose.
- Equipped with 1-1/2 HP, 3650 RPM, 115/230V single phase electric motor wired for 115V.
- Belt driven cutting wheel of high speed steel, hardened and ground for smooth, dust-free, long-lasting service.
- Moving parts shielded by guards.
- Includes a Smooth Cutting Blade (8" with 5/8" arbor size).



Part Number 332T-115V-PFD

Model 332T-115V will cut:

- two wire braid, 1-1/4" maximum
- one wire braid, 2" maximum
- four spiral, 1-1/4" maximum
- recommended for PTFE Hose

Replacement Smooth Cutting Blade

(8" with 5/8" arbor size).....580661-PFD

Replacement Scallop Cutting Blade..... 24398

Karrykut

- Portable power saw
- Makes up hose assemblies on the job.
- Hardened steel blade powered
- 110V (13 amp) universal AC-DC motor.
- Hand grip, trigger control.
- Unique clamp which spreads hose as it is cut to prevent binding of blade.
- Clean cutoff of rubber or cotton covered, wire or fabric reinforced hose
- -4 through -32 inside diameter.



Part Number 631075-PFD

Part Number

Universal Clamp Attachment*..... **631076-PFD**

Replacement Blade (8" with 5/8" arbor size)..... **580661-PFD**

Replacement Power Saw (less clamp and Blade)... **631140-PFD**

*May be used with any portable power saw unit having a 5/8" arbor, 8" blade capacity.

Vise Blocks For Parflex Hose

Part Number

VBS - For Hose Sizes 3, 4, 5, 6, and 8; 3/16", 1/4", 5/16", 3/8" and 1/2" I. D.

VBL - For Hose Sizes 12 and 16; 3/4" and 1" I. D.

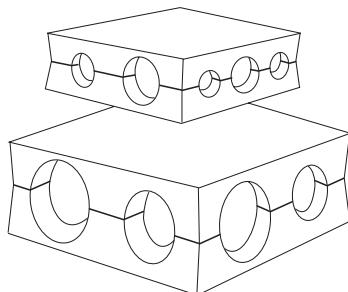

Part Number VBS & VBL

Plastic Tube Cutter

- Easy to handle
- Razor-edged tube cutter
- Closes automatically, assuring clean and square cuts.
- May be used with polyethylene, polypropylene, nylon and other plastic tubing up to 5/8".

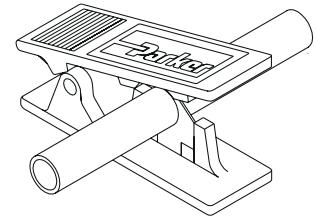

Part Number PTC

Replacement blades - **PTC-001-RB**

Hose Cutoff Tool

- Small
- Easy to use
- Manually operated unit for quick cutting of Parflex hoses (not recommended for wire reinforced).

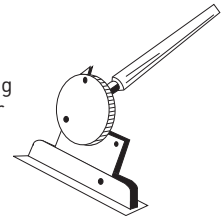

Part Number 316-PFD

Hozemblers

- Facilitates the attachment of Field Attachable hose fittings.
- Handles all types of hose and fittings in sizes -3 through -32 I.D.
- Handles standard bent tube elbows.
- 110V, 30 amp, universal AC-DC motor.

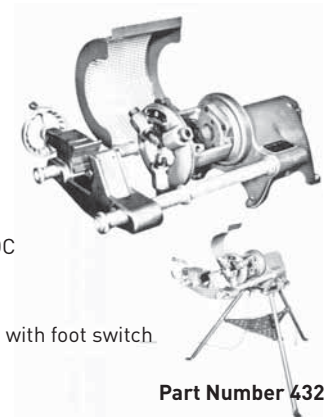

Part Number 432

NOTE: 432 is supplied complete with foot switch and safety guard.

Part Number

Model 432 Hozemblers..... **432-115V**
(complete with vise and all adapters)

Mounting Stands..... **662451**

Replacement Parts

Hose Vise (complete with 662453 and 662454)..... **662452**

Hose Vise Jaw Plate..... **662453**

Hose Vise Jaw Adapter..... **662454**

Chuck Jaws..... **662455**

Request Bulletin 4497-B2 for operating instructions.

NOTE: Hozemblers and all components available through Parker Hose Products Division

Hose Accessories







Visual Index.....227

Hose Guards..... 228-230

Spring/Armor/PVC Guard Selection Tables.....231

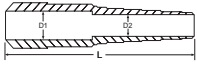
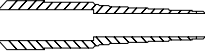
702 Oil232

Hose Accessories Visual Index

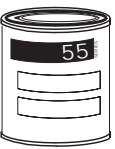
Hose Accessories					
 Hose Guards	Clear Vinyl Hose Guards  pg. 228	Hose Bend Restrictor (HBR)  pg. 228	CNG Hose Guard Kit  pg. 228	Pre-made Spring Guards  pg. 229	Steel Spring Guards  pg. 229
Flat Steel Armor Guards  pg. 229	 Hose Oils	702 Lubricant  pg. 232			

Additional Accessories Available		
Components, Accessories	Division	Contact Information
Tube Fitting Adapters	Tube Fitting Division	Phone: 614/279-7070 Fax: 614/279-7685 www.parker.com/tfd
Seal-Lok™ O-Rings	Tube Fitting Division	Phone: 614/279-7070 Fax: 614/279-7685 www.parker.com/tfd
Hose Protective Sleeving	Hose Products Division	Phone: 440/943-5700 Fax: 440/943-3129 www.parkerhose.com
Hose Clamps	Hose Products Division	Phone: 440/943-5700 Fax: 440/943-3129 www.parkerhose.com
Flange Kits (Code 61, 62, DIN & ISO)	Hose Products Division	Phone: 440/943-5700 Fax: 440/943-3129 www.parkerhose.com
Protection Shields	Hose Products Division	Phone: 440/943-5700 Fax: 440/943-3129 www.parkerhose.com

Hydraulic & Pneumatic Hose & Fit.

PTFE Hose & Fittings

Thermoplastic Tubing

Coiled Air Hose, Fittings & Accessories

Truck (Fleet) Products

Tooling & Equipment

Hose Accessories

Technical & Design Information

Approvals & Guides

Alphanumeric Index

Clear Vinyl Hose Guard



Part Number	Guard I.D. inch	Standard Length feet
#		
PV97-1	0.44	100
PV139-1	0.56	100
PV1611-1	0.68	100
PV2014-1	0.87	50
PV2420-1	1.25	50
PV3224-1	1.50	50

Black Elastomer Hose Bend Restrictor (HBR)

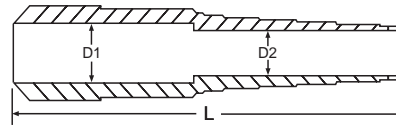

Hose Guard Number	Hose Size	L inch	D1 inch	D2 inch
#				
HBR-4	1/4	5	.600	.500
HBR-6	3/8	6	.640	.625

Note: Parker reserves the right to change dimensions and performance parameters without notice.

Black Vinyl CNG Hose Guard

- Use with Parflex CNG hose
- Each Guard Kit contains two vinyl hose guards (similar to HBR above) and warning tag.

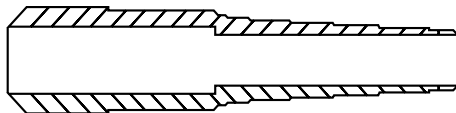

Hose Part Number	Hose Guard Kit Part Number
#	#
3CNG/CNGLT/CNGFR-4	CNGG3-4
3CNG/CNGLT/CNGFR-6	CNGG3-6
3CNG/CNGLT/CNGFR-6/540N-2 TWINLINE	CNGG6-2
4CNG/CNGLT/CNGFR-6	CNGG4-6
5CNG/CNGLT/CNGFR-3	CNGG5-3
5CNG/CNGLT/CNGFR-4	CNGG5-4
5CNG/CNGLT/CNGFR-6	CNGG5-6
5CNG/CNGLT/CNGFR-8	CNGG5-8
5CNG/CNGLT/CNGFR-12	CNGG5-12
5CNG/CNGLT/CNGFR-16	CNGG5-16

Hydraulic & Pneumatic Hose & Fit.
PTFE Hose & Fittings
Thermoplastic Tubing
Coiled Air Hose, Fittings & Accessories
Truck (Fleet) Products
Tooling & Equipment
Hose Accessories
Technical & Design Information
Approvals & Guides
Alphanumeric Index

Use Spring Guards for protection from abrasion and extreme physical abuse.

Pre-made Spring Guards (Plated, hard-drawn steel wire)

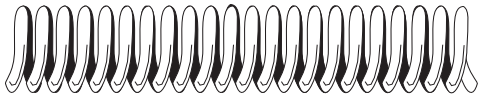

Standard

Part Number	Guard I.D. inch	Standard Length inch
#		
55SSG-3	0.47	5
55SSG-4	0.55	5
55SSG-5	0.61	5
55SSG-6	0.68	5
55SSG-8	0.83	5
55SSG-12	1.09	7

For CPS/CNG Hose

Part Number	Guard I.D. inch	Standard Length inch
#		
3PSG-2	0.39	4.60
3PSG-3	0.46	5.30
3PSG-4	0.54	6.25
3PSG-6	0.72	6.50
5PSG-4	0.63	6.25
5PSG-6	0.78	6.50
5PSG-8	0.90	6.50

Special configurations available upon request. Contact factory.

Steel Spring Guards (Plated, hard-drawn steel wire)

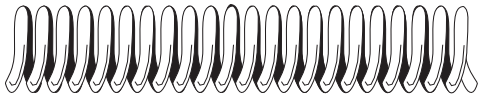

Part Number	Guard I.D. inch	Standard Length feet
#		
55SG-3	0.47	25
55SG-4	0.55	25
55SG-5	0.61	25
55SG-6	0.67	25
55SG-8	0.83	25
55SG-12	1.09	10
55SG-16	1.35	10
58SG-12	1.18	10
58SG-16	1.51	10

Flat Steel Armor Guards



Part Number	Guard I.D. inch	Standard Length feet
#		
55AG-3	0.47	25
55AG-4	0.55	25
55AG-5	0.61	25
55AG-6	0.67	25
55AG-8	0.83	25
55AG-12	1.09	10
55AG-16	1.35	10
58AG-12	1.18	10
58AG-16	1.51	10

Guards for PTFE Hoses

Hose		Max. O.D.	Partek Sleeve	External Round Spring	Internal Round Spring	External Flat Spring	Internal Flat Spring	Fire Sleeve	External Anti-Kink Casing	Clear Vinyl Sleeve
919/929	-3	0.25	-	2625-10	-	2740-10	-	-	-	PV75-1
	-4	0.32	-	2625-11	-	2740-11	-	FS-F-5	MG-038-015C	PV86-1
	-5	0.40	-	2625-14	-	2740-14	-	FS-F-7	MG-044-015C	PV97-1
	-6	0.46	AS-Y-11/AS-B-11	2625-15	-	2740-16	-	FS-F-8	MG-050-015C	PV108-1
	-8	0.56	AS-Y-11/AS-B-11	2625-19	-	2740-19	2613-13CR	FS-F-10	MG-062-015C	PV1310-1
	-10	0.66	AS-Y-13/AS-B-13	2625-22	-	2740-22	2613-16CR	FS-F-12	MG-075-015C	PV1411-1
	-12	0.79	AS-Y-15/AS-B-15	2625-26	-	2740-26	2613-20CR	FS-F-14	MG-081-015C	PV1814-1
	-16	1.05	AS-Y-17/AS-B-17	2625-34	-	2740-34	2613-28CR	FS-F-20	MG-112-015C*	PV2218-1
	-20	1.32	AS-Y-22/AS-B-22	2625-44	-	2740-44	2613-37CR	FS-F-24	MG-144-015C	-
936	-4	0.56	AS-Y-11/AS-B-11	2625-20	-	2740-20	-	FS-F-11	-	-
	-6	0.69	AS-Y-13/AS-B-13	2625-24	-	2740-24	-	FS-F-14	-	-
	-8	0.86	AS-Y-15/AS-B-15	2625-29	-	2740-31	-	FS-F-16	-	-
	-10	0.96	AS-Y-17/AS-B-17	2625-35	-	2740-35	-	FS-F-18	-	-
	-12	1.12	AS-Y-19/AS-B-19	2625-38	-	2740-38	-	FS-F-20	-	-
	-16	1.43	AS-Y-27/AS-B-27	2625-50	2799-16CR	2740-50	-	FS-F-24	-	-
	-20	1.80	AS-Y-35/AS-B-35	2625-70	2799-20CR	2740-60	-	FS-F-32	-	-
	-24	2.05	AS-Y-37/AS-B-37	2625-72	2799-24CR	2740-70	-	FS-F-38	-	-
	-32	2.60	AS-Y-45/AS-B-45	2625-87	2799-32CR	2740-83	-	FS-F-48	-	-
939	-4	0.48	AS-Y-11/AS-B-11	2625-16	-	2740-18	-	FS-F-10	-	-
	-6	0.59	AS-Y-13/AS-B-13	2625-20	-	2740-20	-	FS-F-11	-	-
	-8	0.75	AS-Y-15/AS-B-15	2625-25	-	2740-25	-	FS-F-14	-	-
	-10	0.88	AS-Y-17/AS-B-17	2625-29	-	2740-30	-	FS-F-16	-	-
	-12	1.09	AS-Y-19/AS-B-19	2625-36	-	2740-36	-	FS-F-20	-	-
	-16	1.33	AS-Y-27/AS-B-27	2625-44	2799-16CR	2740-44	-	FS-F-24	-	-
	-20	1.75	AS-Y-35/AS-B-35	2625-58	2799-20CR	2740-58	-	FS-F-32	-	-
	-24	2.05	AS-Y-39/AS-B-39	2625-67	2799-24CR	2740-70	-	FS-F-38	-	-
	-32	2.56	AS-Y-47/AS-B-47	2625-83	2799-32CR	2740-83	-	FS-F-48	-	-
943	-6	0.49	AS-Y-11/AS-B-11	2625-17	-	2740-18	-	FS-F-10	-	-
	-8	0.62	AS-Y-13/AS-B-13	2625-21	-	2740-21	2613-13CR	FS-F-11	-	-
	-10	0.73	AS-Y-15/AS-B-15	2625-24	-	2740-23	2613-16CR	FS-F-14	-	-
	-12	0.99	AS-Y-17/AS-B-17	2625-33	-	2740-35	2613-20CR	FS-F-18	-	-
	-16	1.39	AS-Y-27/AS-B-27	2625-45	-	2740-46	2613-28CR	FS-F-24	-	-

*MG-112-015C to be used on 919-16 only.

Footnotes:

Partek sleeves come in yellow and black.

All internal guards are fabricated from 300 series stainless steel.

All external guards are plated steel.

Spring Guards, Armor Guards and PVC Guards

Parker hose guards prolong the life of hoses that are exposed to rugged operating conditions. In addition to protecting the hose from abrasion and cutting, they limit the bending radius which prevents kinking.

Hose Style	Armor Guards/Spring Guards								
	55AG-3 55SG-3	55AG-4 55SG-4	55AG-5 55SG-5	55AG-6 55SG-6	55AG-8 55SG-8	55AG-12 55SG-12	55AG-16 55SG-16	58AG-12 58SG-12	58AG-16 58SG-16
510/510A/510C/518C	-2, -3	-4	-5	-6	-8	-12	-16		
520N/528N	-3	-4	-5	-6	-8				
540N/540P	-2, -3	-4	-5	-6	-8	-12			
55LT	-2, -3	-4	-5	-6	-8	-10, -12	-16		
55FR		-4		-6	-8	-12			
560/563	-3	-4	-5	-6	-8	-10		-12	
575X	-3	-4		-6	-8		-12		
580N/588N				-4	-6	-8, -10		-12	-16
53FR					-6	-8		-12	
573X/573XL	-3								-16
590, 593	-3	-4		-6	-8	-10		-12	-16
PSH/3PSH/4PSH/HPSH						-8, -10		-12	-16
MSH		-5		-6					
56DH/568DH	-2								
PTH	-3								
1035A/1035HT		-4		-6					
53LT/538LT	-3	-4		-5	-6	-8, -10	-12		
GPH	-3	-4, 5	-5	-6	-8	-10, -12	-16		
515A, 515H, 515X	-3, -4	-5	-6		-8				
570A				-6	-8				

Hose Style	PVC Guards						
	PV97-1	PV139-1	PV1611-1	PV2014-1	PV2218-1	PV2420-1	PV3224-1
510/510A/510C/518C	-2	-3, -4	-5, -6	-8	-12		-16
520N/528N		-3, -4	-5, -6	-8			
540N/540P	-2	-3, -4	-5, -6	-8	-12		
55LT	-2	-3, -4	-5, -6	-8	-10, -12		-16
55FR		-4	-6	-8	-12		
560/563		-3, -4	-5, -6	-8	-10	-12	
575X		-3, -4	-6	-8		-12	
580N/588N			-4	-6	-8, -10	-12	-16
53FR/530				-6	-8	-12	
573X/573XL	-3						-16
590		-3, -4	-6	-8	-10	-12	-16
PSH/3PSH/4PSH/HPSH					-8, -10	-12	-16
MSH		-5	-6				
56DH/568DH (PV96-1)	-2						
PTH		-3					
1035A/1035HT		-4	-6				
53LT/538LT		-3, -4	-5	-6	-8, -10		-12
GPH	-3	-4	-5, -6	-8	-10, -12	-12	-16
515A, 515H, 515X	-3	-4, -5	-6	-8			
570A			-6	-8			

Hydraulic & Pneumatic Hose & Fit.

PTFE Hose & Fittings

Thermoplastic Tubing

Coiled Air Hose, Fittings & Accessories

Truck (Fleet) Products

Tooling & Equipment

Hose Accessories

Technical & Design Information

Approvals & Guides

Alphanumeric Index

702 Oil for Stainless Steel Fittings

- This lubricant must be used when assembling stainless steel swage fittings.
- The O.D. of the fitting and the I.D. of the swager dies must be coated with 702 oil.
- Incorrect application of 702 Oil may result in swage assembly failure.



Part Number 702-OIL

Technical and Design Information

Technical & Design Tutorial & Information	234
Dash Sizes for Hose & Tubing	235
Metric Conversion Chart.....	236

Hose Assembly Instructions

Twin/Multi-Line Separation	237
Hose Assembly & Crimping.....	238-243
Field Attachable Fitting Assembly.....	244-245
90 Series Field Attachable Assembly	246-248
Ferrul-Fix Installation	249
PMM-1 Portable Swage	250
SQ Swage	251-253
MiniKrimp™	254-255
Crimp Specification & Tool Selection Chart	256-259
Swage Specification & Tool Selection Chart	260-261
Swage & Crimp Die Selection Chart.....	262-266

Hose Selection, Installation & Maintenance

Recommended Practices for Hydraulic Hose Assemblies	267-271
Selection of Hose Diameter	272-273
Calculation of Hose Length for Over-the-Sheave Applications	274
Hose Permeation Data.....	275

Hose Fittings

Thread Guide.....	276
Pressure Ratings	273

Materials

Media to Fitting & Seal Compatibility.....	278
Metal Tube and Fitting Material Compatibility.....	279
O-Ring Selection	280
Metals Corrosion Scale.....	281
Materials to Parflex Part Number Table	282
Media to Hose Material Compatibility	283-286
Media to Plastic Tubing Material Compatibility	287-289

Extra care is taken in the preparation of this literature but Parker is not responsible for any inadvertent typographical errors or omissions. Information subject to change without notice. The information in this catalog is only accurate as of the date of publication. For a more current information base, please consult the Parker Parflex Division web site at www.parker.com/parflex.



Hose Assemblies Tutorial

- Review twin/multi-line hose separation page if applicable- this will give you information before proceeding to the assembly pages- not following this procedure may cause permanent damage to hoses
- Review the PMM (Parker Minute Machine) hand swaging machine information if swaging- further information is included with each PMM unit
- Steps for crimping are clearly marked with sequences showing product distinctions (shown in bold panels to the left) between products lines
 - Crimping section as well as universal preparations for all hoses appear first
 - Field attachable, assemblies appear next
 - References to specific pages and sequences are clearly indicated (e.g. for 90 series field attachable fittings skip to page 246)
- The crimping machine shown in the examples is a PARKRIMP I machine*

*The Hose Products Division Parkrimp I is used as an example in this section for illustration and instruction purposes. The PARKRIMP crimping system is the same for all standard Parker portable or bench style crimpers. Please note: You must become familiar with your own specific crimper to determine its operational features. Please review thoroughly and understand your operator's manual included with your machine. Never use a crimper beyond its recommended published capacities. Crimp specifications can be found in this catalog and on line by accessing Crimp Source. www.parker.com/dayco/csonline/crimpsource.asp

Dash Sizes for Hose and Tubing

Dash sizes are commonly used to designate hose I. D., plastic tubing and metal tubing O. D. and coupling size. Dash size systems in common use:

Nominal Hose I. D. or Tubing O. D.		Dash Number for all SAE Hose Except 100R5	Dash Number for SAE 100R5	Dash Number for TFE Hose	Nominal DIN Size
Inches	Millimeters				
1/8	3,2	-2	-	-	-
3/16	4,8	-3	-4	-4	5
1/4	6,3	-4	-5	-5	6
5/16	7,9	-5	-6	-6	8
3/8	9,5	-6	-	-	10
13/32	10,3	-6.5	-8	-8	-
1/2	12,7	-8	-10	-10	12
5/8	15,9	-10	-12	-12	16
3/4	19,1	-12	-	-	20
7/8	22,2	-14	-16	-16	-
1	25,4	-16	-	-	25
1-1/8	28,6	-	-20	-20	-
1-1/4	31,8	-20	-	-	32
1-3/8	34,9	-	-24	-24	-
1-1/2	38,1	-24	-	-	40
1-13/16	46,0	-	-32	-32	-
2	50,8	-32	-	-	-

Hydraulic & Pneumatic Hose & Fit.

PTFE Hose & Fittings

Thermoplastic Tubing

Coiled Air Hose, Fittings & Accessories

Truck (Fleet) Products

Tooling & Equipment

Hose Accessories

Technical & Design Information

Approvals & Guides

Alphanumeric Index

Metric Conversion Chart

	English to Metric			Metric to English		
	To Convert From	To	Multiply By	To Convert From	To	Multiply By
Area	sq. in. (in ²)	sq. mm (mm ²)	645.16	sq. mm (mm ²)	sq. in. (in ²)	0.00155
	sq. in. (in ²)	sq. cm (cm ²)	6.4516			
	sq. ft. (ft ²)	sq. meters (m ²)	0.0929			
Density	pounds/cubic foot (lb./ft ³)	kilograms/cubic meter (kg/m ³)	16.02	kilograms/cubic meter (kg/m ³)	pounds/cubic foot (lb./ft ³)	0.0624
Energy	British Thermal Units (Btu) (1 J=Ws=0.2388 cal)	joules (J)	1055	joules (J)	British Thermal Units (Btu)	0.000947
Force	pounds - force (lbf) (1N=0.102 kgf)	newtons (N)	4.448	newtons (N)	pounds - force (lbf)	0.2248
Length	inches (in)	millimeters (mm)	25.4	millimeters (mm)	inches (in)	0.03937
	feet (ft)	meters (m)	0.3048	meters (m)	feet (ft)	3.281
	miles (mi)	kilometers (km)	1.609	kilometers (km)	miles (mi)	0.621
Mass (Weight)	ounces (oz.)	grams (g)	28.35	grams (g)	ounces (oz.)	0.035
	pounds - mass (lb)	kilograms (kg)	0.4536	kilograms (kg)	pounds - mass (lb)	2.205
	short tons (2000 lb) (tn)	metric tons (100 kg) (t)	0.9072	metric tons (100 kg) (t)	short tons (2000 lb) (tn)	1.102
Power	horsepower (550 ft lb/s) (hp)	kilowatts (kW)	0.7457	kilowatts (kW)	horsepower (550 ft lb/s) (hp)	1.341
Pressure	pounds/square inch (PSI)	kilograms (f)/square cm (kgf/cm ²)	0.7457	kilograms (f)/square cm (kgf/cm ²)	pounds/square inch (PSI)	14.22
		kilopascals (kPa)	0.0703	kilopascals (kPa)		0.145
		bars (100 kPa)	6.8948	bars (100 kPa)		14.503
Stress	pounds/square inch (PSI) (1N/mm ² =1MPa)	megapascals (MPa)	0.006895	megapascals (MPa)	pounds/square inch (PSI) (1N/mm ² =1MPa)	145.039
Temperature	degrees Fahrenheit (°F)	degrees Celsius (°C)	5/9 (after subtracting 32)	degrees Celsius (°C)	degrees Fahrenheit (°F)	9/5 (then add 32)
Torque or Bending Moment	pounds-force-foot (lb-ft)	Newtons-meter (Nm)	1.3567	Newtons-meter (Nm)	pounds-force-foot (lb-ft)	0.737
	pounds-force-inch (lb-in)		0.113		pounds-force-inch (lb-in)	8.85
Velocity	feet/second (ft/s)	meters/second (m/s)	0.3048	meters/second (m/s)	feet/second (ft/s)	3.2808
Viscosity	dynamic (centipoise)	Pascal-second (Pas)	.001	Pascal-second (Pas)	dynamic (centipoise)	1000
	denematic - foot ² /sec (ft ² /s)	meter ² /sec (m ² /s)	0.0929	meter ² /sec (m ² /s)	denematic - foot ² /sec (ft ² /s)	10.7643
Volume	cubic inch (in ³)	cubic centimeter (cm ³) (milliliter)	16.3871	cubic centimeter (cm ³) (milliliter)	cubic inch (in ³)	0.061
	quarts (qt)	liters (1000 cm ³)	0.9464	liters (1000 cm ³)	quarts (qt)	1.057
	gallons (gal)	liters	3.7854	liters	gallons (gal)	0.2642

Factory-built assemblies are available using twin/multi-line hoses. When field-built assemblies are preferred, the following steps must be taken.

1 SET-UP

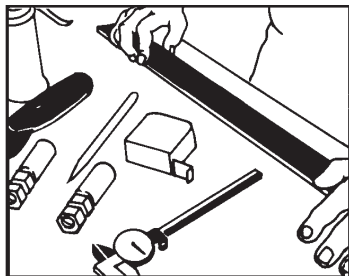

Position twinned or multi-line hose assembly so that it lies flat on work surface without tendency to twist or turn.

4 CUT HOSE TO LENGTH

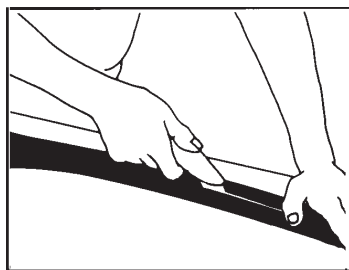

Press the multi-line hose assembly firmly and flat against the work surface with your free hand so that it does not move. Using a Stanley trimming knife model No. 10-515 or equivalent, draw the knife toward you with constant light to moderate pressure, and a smooth stroke. Multiple strokes will be necessary to separate the hoses.

NOTE

It is important that the knife blade be perpendicular to the hose during this procedure so that the blade cuts only the center line of the web. **EXTREME CARE MUST BE TAKEN TO AVOID CUTTING THROUGH THE COVER OF THE HOSES AND THEREBY EXPOSING THE HOSE REINFORCEMENT.** If this occurs, the hose assembly must be discarded. [See sketch A.] If the separation length is greater than that which can be accomplished with one continuous, smooth stroke, then the procedure should be repeated over shorter distances always cutting toward the free end of the hoses.

2 MEASURE HOSE TO LENGTH

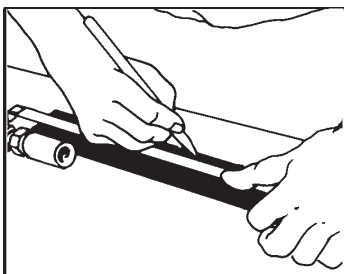

Measure and mark the length that the hoses are to be separated.

NOTE:

If length of separation is specified from the threaded or swivel nut end of coupling, deduct the cutoff allowance dimension for the specific style of coupling used. The cutoff allowance is obtainable from the hose fitting tables or can be calculated by subtracting the insertion depth of the shell from the overall coupling length.

5 MEASURE SEPARATION

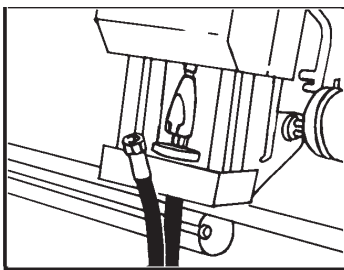

It is suggested that the separation length be sufficiently long so that the swaging or crimping operation can be accomplished without risk of kinking the hoses or tearing the web which could result in exposure of the hose reinforcement. (See sketch B)

A INCORRECT HANDLING



A DON'T
EXTREME CARE MUST BE TAKEN TO AVOID CUTTING THROUGH THE COVER OF THE HOSES AND THEREBY EXPOSING THE HOSE REINFORCEMENT. If this occurs, the hose assembly must be discarded.

3 LUBRICATE

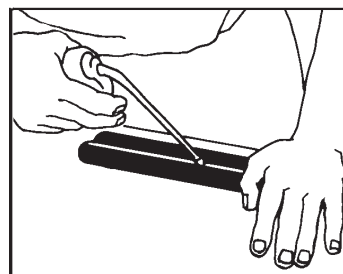

Lightly lubricate the web area between the hoses. Distribute the lubricant uniformly along the web of the assembly to be separated. Any lightweight oil will suffice. (SAE 10 or 20) The function of the oil is to reduce the friction of the knife blade so that it naturally seeks the center of the valley formed by the hoses. This eliminates the need for the operator to steer the knife.

6 APPLY TAPE

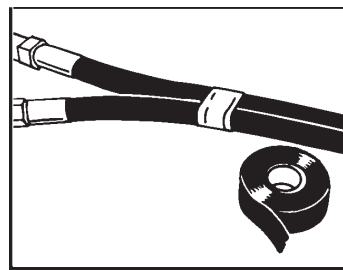

At the option of the assembler as dictated by the installation, it is suggested that a nylon lashing strap or tape be applied at the termination of the separated length to provide protection against tearing of the web or hose covers.

B INCORRECT HANDLING

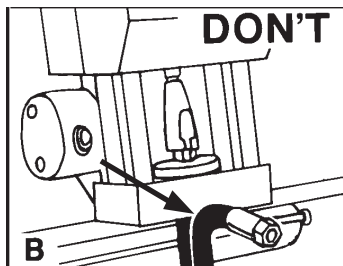

B
The separation length must allow for the swaging or crimping operation without damaging the hose.

ALL HOSES

1 MEASURE & CUT HOSE TO LENGTH



Verify the type and size hose printed on layline match work order.

NOTE:

When calculating hose length, take into consideration the change in hose length (expansion/contraction) that may occur during pressurization.

Using a flexible or rigid measuring tape, measure the length of hose required as follows:

- a. Verify required length of hose assembly with fittings.
- b. Subtract "Cutoff Allowance" of each fitting from hose assembly length. (Refer to Hose Fittings Tables in Catalog 4660 for proper cutoff allowances)

EXAMPLE:

Hose assembly length with fittings = 12"

Fitting Cutoff Allowance (125HBL-6-6) 3/4"

Fitting Cutoff Allowance (125HBL-6-6) 3/4"

Total Cutoff Allowance 1-7/16"

12" - 1-7/16" = 10-9/16"

Length of hose required = 10-9/16"

2 MEASURE & CUT HOSE TO LENGTH

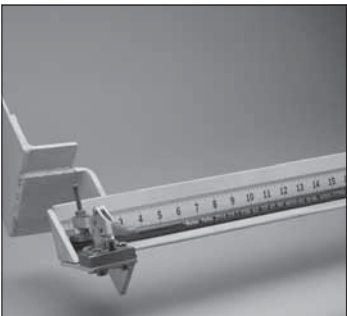

Secure hose in some type of fixture to ensure straightness.

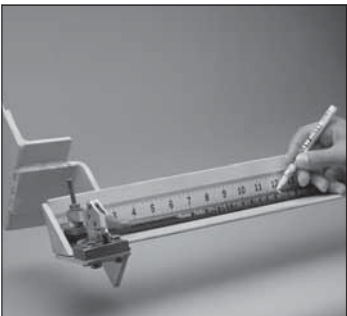

Measure and mark hose.

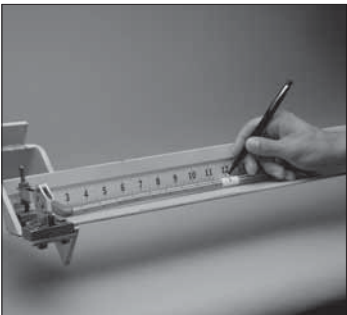

Tape hose securely so mark is in center of tape and mark tape. 919U hoses can not be taped.

CAUTION:

Do not use abrasive wheels to cut hose. Abrasive wheels will damage core tube.

3 MEASURE & CUT HOSE TO LENGTH

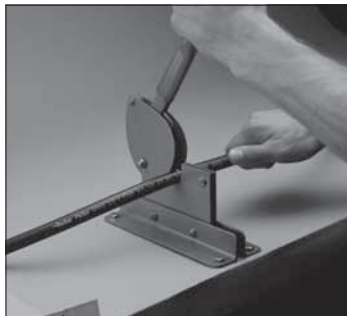

Using a Parker Model 316 cutoff tool, Parflex PHC hand cutter or other sharp cutter, cut hose squarely to correct length.



Using a Parker Model 332-T-115V Hose Cutoff Machine or fine-toothed hacksaw, cut hose squarely to length.

A power hose cutoff saw should always be used on PTFE and wire reinforced thermoplastic and hybrid hoses.

4 INSPECT HOSE

HYBRID & THERMOPLASTIC

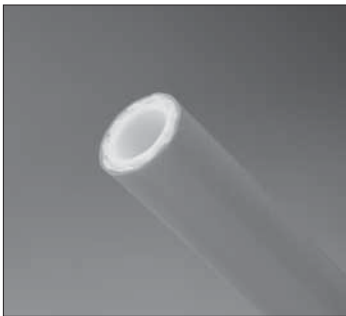

Visually inspect both ends of hose for squareness.. Remove any burrs on core tube with a sharp knife.

GPH HOSES

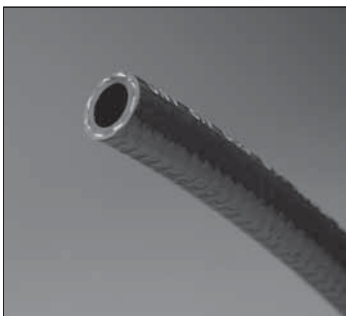

Visually inspect both ends of hose. Ensure end of hose is cut squarely, has no loose or frayed reinforcement and core tube is not damaged. Trim hose as required.

PTFE HOSES

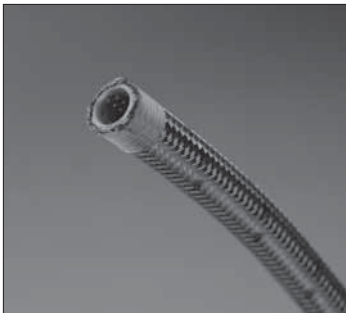

Visually inspect both ends of hose for squareness, loose wires and burrs on core tube. Trim any loose wires flush with tube and remove any burrs on tube with a sharp knife.

SQ SWAGER ASSEMBLY:
For swaged Predator Hose assemblies using the SQ-101 swager, please proceed to page 251.

5 INSPECT FITTINGS



Verify fitting part number(s) match work order.

Visually inspect fitting(s) for a through-hole, threads and damage.



Verify fitting and ferrule part number(s) match work order.



Verify fitting part number(s) match work order.
Visually inspect fitting(s) for a through-hole, threads and damage.

PTFE FIELD ATTACHABLES:
For further instruction on PTFE 90 Series Field Attachable assembly, please proceed to page 246 for steps 6 - 25.

HYD. FIELD ATTACHABLES:
For further instruction on Hydraulic Field Attachable assembly, please proceed to page 244 for steps 6 - 14.

6 ASSEMBLE HOSE



Mark hose end with proper insertion depth line as follows:

Place fitting next to hose and align annular crosshatched ring on fitting with end of hose.

GPH HOSES:
Please proceed to page 240 for continued instruction.

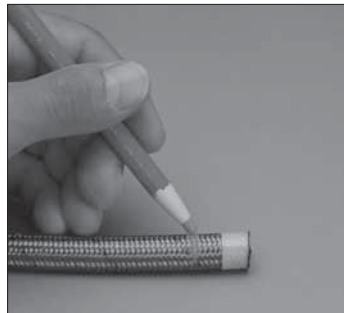

Mark hose end with proper insertion depth line. For 919U hoses, use a sharp knife and light pressure to cut back the urethane cover at least the length of the insertion depth of the fitting.

WARNING:
Do not use lubricating oil when installing fittings on hose used in oxygen service. When installing fittings on hose used in oxygen service lubricate with a non-oil based soap solution. Failure to do so may result in an explosion and personal injury when hose is used.

7 ASSEMBLE HOSE

HYBRID & THERMOPLASTIC



Using a SAE 20 lubricating oil, lightly lubricate inside of hose end. (Use soap solution for oxygen service. This practice should only be done if necessary.)
Push hose into fitting all the

GPH HOSES



Insert hose into ferrule until hose bottoms out against lip of ferrule.

PTFE HOSES

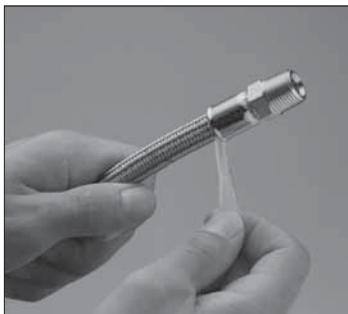

Push fitting onto hose slightly and then remove tape. Continue pushing fitting onto hose until fitting reaches depth insertion mark. (If fitting does not readily slide onto hose, perform the next step.)

8 ASSEMBLE HOSE



way to depth insertion mark. (If fitting does not readily slide onto hose, perform the next step.)



Insert barbed end of fitting through ferrule and into hose I.D.

NOTE: If HBL fitting is difficult to install, water or soap solution may be used as a lubricant.

PTFE: For further instruction on PTFE assembly, please proceed to step 11.

9 ASSEMBLE HOSE



Tap fitting onto hose as follows:
Using Parker VBS or VBL vise blocks, place hose with fitting into proper hole of vise block and place in bench vise.

CAUTION:

Ensure hose extends from vise blocks only enough to clear depth insertion mark. Failure to do this may result in harmful kinking of hose.



Push fitting inward completely until hex of fitting is flush with end of ferrule.

GPH: For further instruction on GPH assembly, please proceed to step 11.

10 ASSEMBLE HOSE

HYBRID & THERMOPLASTIC



Using a rubber mallet, tap fitting onto hose until bottom of fitting shell is aligned with depth insertion mark. Repeat Steps 7-10 for other end of hose if required.

NOTE

The following steps are performed using the Parker Parkrimp I.

NOTE

Pusher slide pin is located inside rear of pusher.

CAUTION

Do not use the black spacer ring on Parflex fittings. Use of the black spacer ring will result in improperly crimped fittings and hose assemblies.

ALL HOSES

11 ASSEMBLE HOSE



Select proper Parkrimp die set. (Refer to Assembly Tool Selection Chart in Catalog 4660 or 4690 for proper Parkrimp die part number.)

12 ASSEMBLE HOSE



Using a molybdenum disulfide type grease, apply a thin layer of grease on bowl of crimper base plate.

13 ASSEMBLE HOSE



Place die set into bowl.

CAUTION

The silver die ring must be used for all Parflex fittings. Failure to do so will result in improperly crimped fittings and hose assemblies.

14 ASSEMBLE HOSE



Place silver die ring on top of die. Position ring so it is centered on die.

CAUTION

When positioning fitting in die, ensure fitting skirt rests on die step. Failure to do so will result in an improperly crimped or damaged fitting.

15 ASSEMBLE HOSE

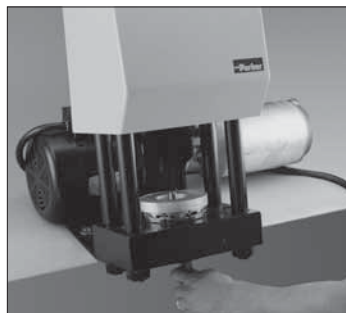

Insert hose and fitting from bottom of crimper and up through die set. Position fitting so bottom of fitting skirt rests on die step.

ALL HOSES

16 ASSEMBLE HOSE

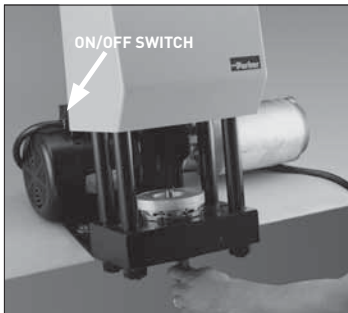

Turn on crimper.

NOTE

Pump on crimper should not exceed 3000 PSI. Parker Hannifin will not accept responsibility for the operation of or provide warranty coverage for a crimper that is operated by a power unit other than equipment supplied by Parker Hannifin for the express purpose of operating the crimper.

WARNING

Keep fingers and hands away from die-pusher area. Failure to do so may result in personal injury.

17 ASSEMBLE HOSE



While holding hose and fitting in position on die step, pull down on handle to activate crimper.

18 ASSEMBLE HOSE



Crimp fitting onto hose until die ring contacts base plate.

19 ASSEMBLE HOSE



Push handle to retract pusher.

20 ASSEMBLE HOSE

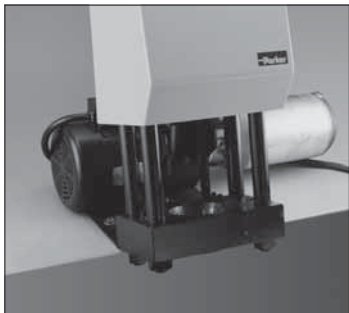

Remove hose assembly and die set.

21 ASSEMBLE HOSE

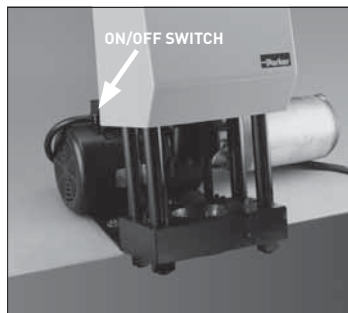

Repeat Steps 13-20 for the other end of hose if required.
Turn off Crimper

ALL HOSES

22 MEASURE & INSPECT

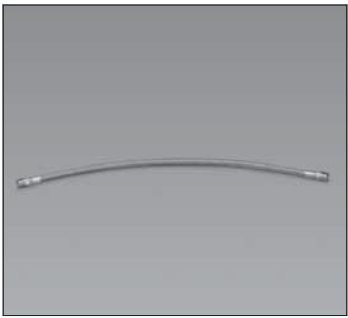

Measure and verify hose assembly length matches work order.

23 MEASURE & INSPECT

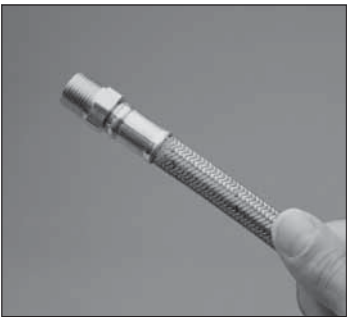

Inspect insertion depth mark at fitting ends. Insertion mark must be visible and within 1/8" of bottom of fitting shell.

24 MEASURE & INSPECT

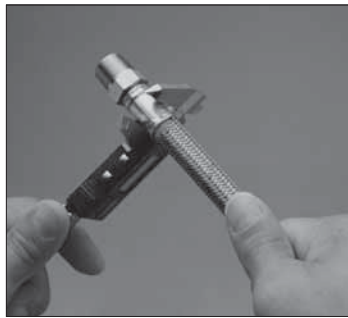

Measure crimp diameter of each fitting at top, middle and bottom of shell. Take measurements at a minimum of three places around shell circumference. Verify crimp diameter is within tolerances. (Refer to Crimp Specification & Tool Selection Chart for proper crimp diameters.)

Pressure test hose assembly if required.

CONTINUED FROM PAGE 239

6 INSPECT FITTINGS



Visually inspect fitting(s) as follows: Inspect socket for threads in shoulder, threads in shell and damage.

7 INSPECT FITTINGS



Inspect nipple for a through-hole, threads, hex and damage. Ensure swivel nut is properly crimped, has threads and turns freely.

8 ASSEMBLE HOSE



Using a SAE 20 lubricating oil, lightly lubricate inside and outside of hose end.

CAUTION

Ensure hose is installed in correct size hole of vise block. Clamping hose in a smaller hole will crush hose.

9 ASSEMBLE HOSE

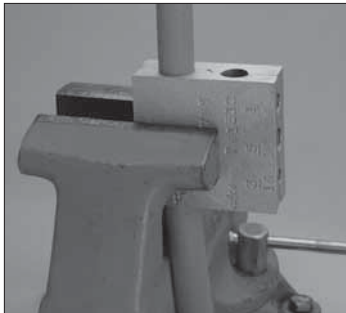

Using a Parker VBS or VBL vise block, place hose in proper hole of vise block and place in bench vise. Ensure enough hose extends from vise block to install socket.

CAUTION

Socket should be firm when tightened but not difficult to turn. If socket is difficult to install, check hose for proper lubrication. Re-apply lubricating oil as necessary. Installation of socket without proper lubrication may damage hose.

10 ASSEMBLE HOSE



Using a wrench, screw socket onto hose counterclockwise until it bottoms. Ensure end of hose is against inside shoulder. Back off socket 1/4 turn clockwise.

CAUTION

When tightening socket in vise, do not over tighten vise jaws. Over tightening vise jaws will distort internal threads of socket and hamper installation of nipple.

11 ASSEMBLE HOSE



Remove vise block and hose from vise.

Place hex portion of socket into vise and tighten vise. Ensure socket extends past vise jaws enough to allow for installation of nipple.

* 51 series field attachable couplings are not intended for use on hose that has previously been in service.

Hydraulic & Pneumatic Hose & Fit.

PTFE Hose & Fittings

Thermoplastic Tubing

Coiled Air Hose, Fittings & Accessories

Truck (Fleet) Products

Tooling & Equipment

Hose Accessories

Technical & Design Information

Approvals & Guides

Alphanumeric Index

FIELD ATTACHABLES

12 ASSEMBLE HOSE



Using a SAE 20 lubricating oil, generously lubricate nipple threads and hose I.D..

CAUTION

Nipple should be firm when tightened but not difficult to turn. If nipple is difficult to install, check hose for proper lubrication. Re-apply lubricating oil as necessary. Installation of nipple without proper lubrication will damage core tube.

13 ASSEMBLE HOSE

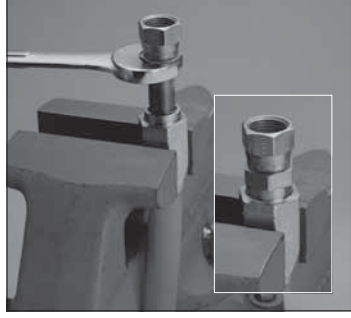

Using a wrench on the nipple hex, screw nipple into socket clockwise until nipple bottoms against socket shoulder.*

* Caution: Ensure hose does not unscrew out of socket when installing nipple.

14 MEASURE & INSPECT



Measure and verify hose assembly length matches work order.

Pressure test hose assembly if required or check hose for leaks after installed.

* 51 series field attachable couplings are not intended for use on hose that has previously been in service.

CONTINUED FROM PAGE 239

6 INSPECT FITTINGS



Verify fitting part number(s) match work order.

7 INSPECT FITTINGS



Visually inspect fitting(s) as follows: Inspect socket for a through-hole, threads in shell and damage.

8 INSPECT FITTINGS



Inspect nipple for a through-hole, threads, hex and damage. Ensure swivel nut is properly crimped, has threads and turns freely.

9 INSPECT FITTINGS



Inspect sleeve for scratches and damage.

10 ASSEMBLE HOSE

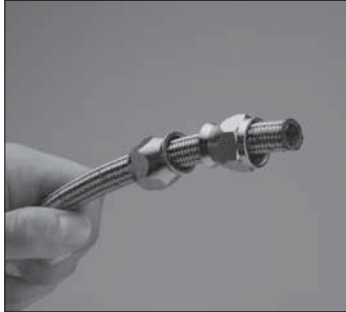

Slide two sockets over end of hose with bottom of sockets back to back.

11 ASSEMBLE HOSE



Position sockets at each end of hose.

NOTE

When installing sockets on hose, check hose ends to determine if wire braid "necks down" (bends inward). If one end "necks down" use this end to slide sockets onto hose.

12 ASSEMBLE HOSE



Mount nipple hex in vise. Ensure nipple end extends beyond vise jaws sufficiently to allow installation of hose.

13 ASSEMBLE HOSE



Push hose bore onto nipple to size tube and to aid in separating braid before fitting sleeve.

14 ASSEMBLE HOSE

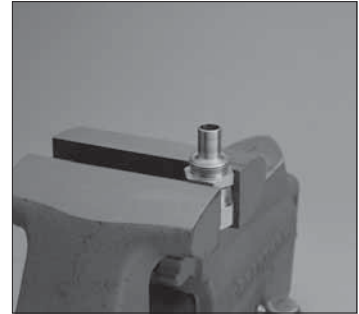

Remove hose from nipple.

90 SERIES

Hydraulic & Pneumatic Hose & Fit.

PTFE Hose & Fittings

Thermoplastic Tubing

Coiled Air Hose, Fittings & Accessories

Truck (Fleet) Products

Tooling & Equipment

Hose Accessories

Technical & Design Information

Approvals & Guides

Alphanumeric Index

90 SERIES

15 ASSEMBLE HOSE



By hand, push sleeve over end of TFE core tube and under wire braid.

16 ASSEMBLE HOSE

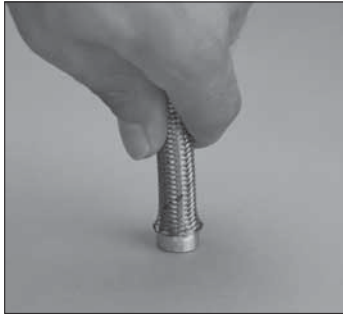

To complete positioning of sleeve, push hose end with sleeve, against a solid flat surface.

17 ASSEMBLE HOSE

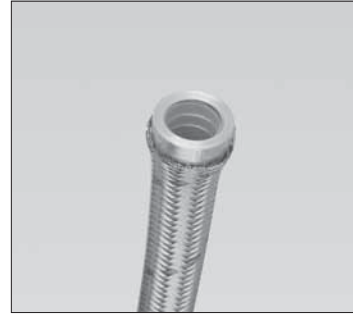

Verify tube butts against inside shoulder of sleeve.

18 ASSEMBLE HOSE

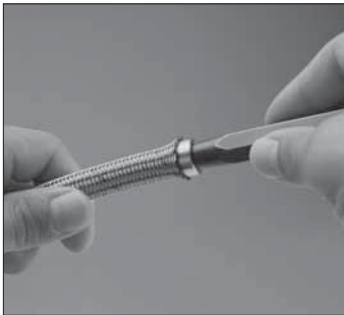

Using a tapered punch, push punch into end of sleeve and tube to set sleeve barbs into tube.

WARNING

Do not use lubricating oil when installing fittings on hose used in oxygen service. When installing fittings on hose used in oxygen service lubricate with a non-oil based soap solution. Failure to do so may result in an explosion and personal injury when hose is used.

19 ASSEMBLE HOSE

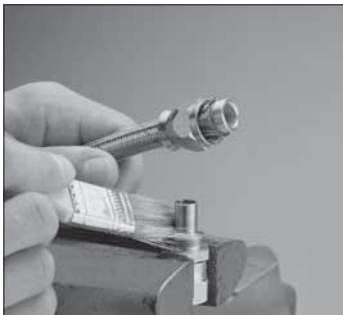

Using a SAE 20 lubricating oil, lubricate nipple and socket threads. For stainless steel fittings use Parker 702 Oil or a molybdenum type lubricant. For hose used in oxygen service lubricate using a non-oil based soap solution. Using a twisting motion, push hose

20 ASSEMBLE HOSE



over nipple until hose is seated against nipple chamfer. Push socket forward and hand-

Hydraulic & Pneumatic Hose & Fit.

PTFE Hose & Fittings

Thermoplastic Tubing

Coiled Air Hose, Fittings & Accessories

Truck (Fleet) Products

Tooling & Equipment

Hose Accessories

Technical & Design Information

Approvals & Guides

Alphanumeric Index

90 SERIES

21 ASSEMBLE HOSE

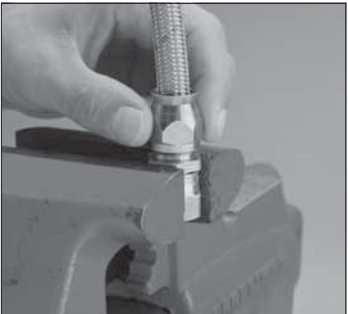

start threading of socket to nipple.

CAUTION

When tightening socket in vise, do not over tighten vise jaws. Over tightening vise jaws will distort internal threads of socket and hamper installation of nipple.

24 ASSEMBLE HOSE

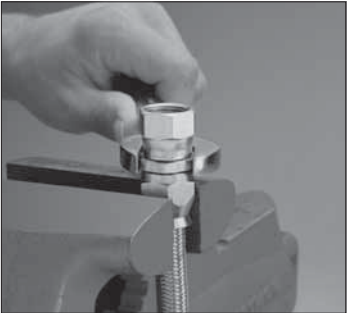

Tighten further to align corners of nipple and socket hexes if necessary.

Repeat Steps 12-24 for other end of hose.

22 ASSEMBLE HOSE

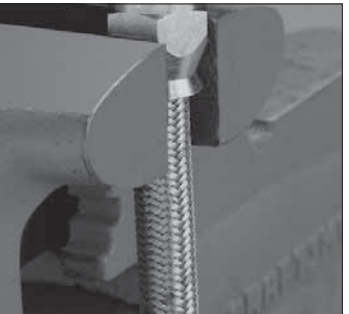

Remove assembly from vise and reposition with socket in vise jaws. Ensure socket extends beyond vise jaws far enough to allow nipple to be completely tightened.

25 MEASURE & INSPECT

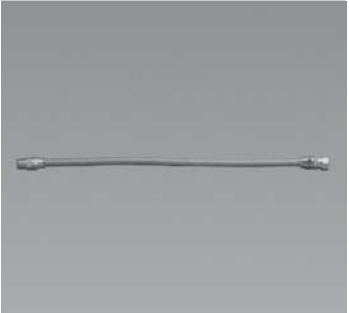

Measure and verify hose assembly length matches work order. Pressure test hose assembly if required.

23 ASSEMBLE HOSE

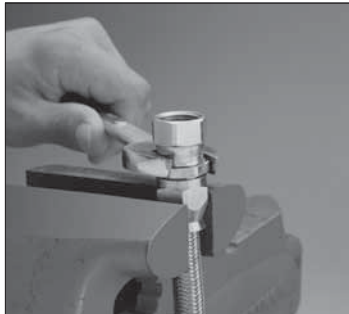

Wrench tighten nipple hex until clearance between hex and socket hex is 1/32" or less.

Ferrul-Fix Installation Instructions

Ferrul-Fix

Fast, on-the-job repair for ruptured bent tube hose assemblies and power steering lines.

The life of the combination tube-hose assembly is often limited to the service life of the hose alone. A replacement assembly may not be available, since equipment dealers are unable to stock all of the many odd tube configurations.

Parker Ferrul-Fix hose end fitting now makes it possible to salvage the bent tube section of the original assembly for replacement. Most importantly, it gets you back into operation FAST!

- **Gets you back in operation fast** — No costly delays while replacement assemblies are rushed from the factory.
- **Lets you reuse expensive bent tube ends** — You can replace the hose at a fraction of the cost of complete assembly.
- **Eliminates need for emergency brazing or welding in the field** — Ferrul-Fix can be assembled without special tools or equipment.

3-Piece Design — body, nut, ferrule. Wedging action of ferrule, when drawn down by nut, forms seal between body and ferrule, while cutting edge of ferrule bites into tube wall forming another positive seal.

Visible Bite — Extent of bite at cutting edge of ferrule is completely visible when fitting is disassembled, an important safety feature. Self-centering action assures an even bite around circumference of tube.

Parkerized Finish — Ferrul-Fix fittings have the Parkerized black finish, providing built-in torque in make-up.

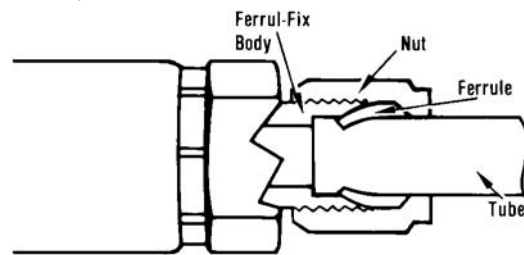

Ferrul-Fix Installation Instructions

1. Cut the formed tube off squarely next to the permanent hose fitting. Lightly debur the end of the tube internally and externally.
2. Disassemble the Ferrul-Fix fitting, and lubricate threads and both ends of the ferrule with Parker Ferulube.
3. Slide nut and ferrule onto tubing with the long, straight end of the ferrule pointing toward the tube end.
4. Insert tube end into the Ferrul-Fix body until it bottoms against the shoulder. Slide ferrule inside body, and screw nut down finger tight.
5. Wrench nut down 1-3/4 turns to preset the ferrule.
6. Disconnect nut and inspect lead edge of ferrule to make certain that the biting edge has turned up a shoulder to a height of at least 50% of the ferrule and completely around the tube.
7. Assemble Ferrul-Fix fitting to hose. Refer to assembly instructions listed in appropriate fittings section. Do not assemble to hose before step 1-6.
8. Reassemble tubing into Ferrul-Fix end and turn nut down easily until a sudden increase in force is evident. Turn bent tube to proper position if required. Using two wrenches, one on the fitting nipple hex and the other on the nut, tighten nut an additional 1/6 turn (one wrench flat).

For additional information, see Parker Tube Fittings Division Catalog 4300, Ferulok instructions.

Hydraulic & Pneumatic Hose & Fit.

PTFE Hose & Fittings

Thermoplastic Tubing

Coiled Air Hose, Fittings & Accessories

Truck (Fleet) Products

Tooling & Equipment

Hose Accessories

Technical & Design Information

Approvals & Guides

Alphanumeric Index

Hydraulic & Pneumatic Hose & Fit.

PTFE Hose & Fittings

Thermoplastic Tubing

Coiled Air Hose, Fittings & Accessories

Truck (Fleet) Products

Tooling & Equipment

Hose Accessories

Technical & Design Information

Approvals & Guides

Alphanumeric Index

I. Preparation of PMM-1 Portable Swaging Machine

Clean and lubricate Acme lead screw assembly. Use lightweight lithium or molybdenum-based grease.

Clean and relubricate as required, particularly if the tool has been exposed to dust or dirt during storage.

II. Versatile Features of PMM-1 Include

Three methods of mounting: bench, vise, or horizontal unsecured for ground or flat work surface.

Swage die retaining clips for horizontal position.

Thumbscrew for quick change of coupling pushers.

Optional crank handle box end wrench part number **821072**.

III. Swaging in Vertical Bench Mounting Position

Install appropriate pusher, part number selected from coupling style charts in 4660 Parflex catalog fitting section.

Clean and lubricate bore of swage dies with high film strength Oil. Repeat after two or three swages. Use Parker 702 oil when swaging stainless steel couplings and lubricate each coupling.

Install two-piece split die in bowl. Select proper die for specific coupling style and hose size from assembly tool selection chart in the 4660 catalog.

After having properly inserted hose into coupling and marking insertion depth, remove or elevate one die segment to allow installation of hose and coupling.

Insert coupling all the way into pusher and exert an upward force; replace die segment in bowl of swager. Verify proper alignment with mating die half.

If lubrication has not previously been accomplished, now is another opportunity to lubricate dies.

Note: To avoid premature wear of dies, it is essential to distribute oil around the complete bore of dies.

Using an appropriate wrench, begin clockwise rotation of hex drive nut. As skirt of coupling approaches the die opening, properly align entry of coupling by deflecting the hose as required continuing to exert an upward force on hose and coupling to keep it fully inserted in pusher.

Note: The crank style box end wrench part number **821072** is recommended as it eliminates slipping and provides easier nonstop rotation of drive nut.

Continue swaging stroke until bottom face of pusher fully contacts top face of dies.

Retract pusher sufficiently to allow removal of swaged coupling.

Measure swaged diameter of coupling and inspect threads of male style couplings for any indication of damage. On female swivel style couplings, inspect for free rotation and condition of nut.

IV. Swaging in Horizontal or Unsecured Position

Position torque reaction arm at 90° to the center line of the machine.

Following insertion of hose/coupling assembly into machines, it is necessary in this position to secure the die halves with the spring retaining clips provided.

In the horizontal position, it is easier and recommended to insert both die halves at the same time after the hose and coupling have been inserted.

Each of the previously specified procedures also applies to use of the PMM-1 swager in this position.

V. Vise Mounting

Secure PMM-1 swager in vise using only the lug or ear provided.

DO NOT ATTEMPT to vise mount by gripping the round and tapered base of the machine. To do so can result in serious injury.

Using the vise lug, the machine may be mounted at an inclined angle or may be mounted horizontally using the full area of the mounting lug; this will be determined by the work area arrangements.

Note: When using the PMM-1 swager in the reaction arm position or the vise mounted position, it will not be possible to maintain constant rotation of the driving nut. It is recommended, however, that a continuous, smooth stroke be maintained whenever possible.



CONTINUED FROM PAGE 239

SEWER HOSE

5 INSPECT FITTINGS



Verify fitting part number matches work order.
Visually inspect fitting for properly crimped shells, internal barbs, a through-hole and damage.

8 ASSEMBLE HOSE

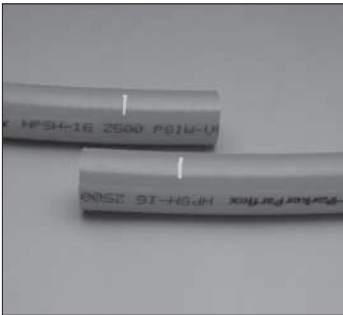

Repeat Steps 4a and 4b for other hose.

6 ASSEMBLE HOSE



Mark each hose end with proper insertion depth line as follows:
Place fitting next to hose and align annular crosshatched ring on fitting with end of hose.

9 ASSEMBLE HOSE



Using a SAE 20 lubricating oil, lightly lubricate inside of both hose ends.

7 ASSEMBLE HOSE

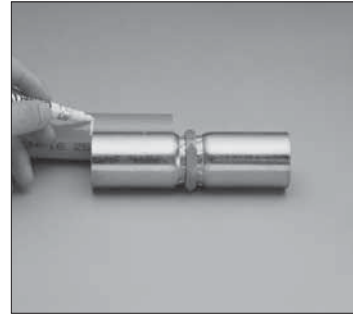

Mark hose at bottom of fitting shell. (Mark indicates the full length in which hose will be inserted into fitting.)

10 ASSEMBLE HOSE

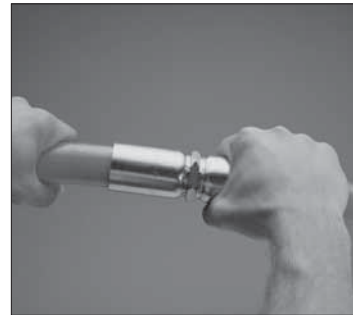

Push each hose end into fitting all the way to depth insertion mark.

NOTE

The following steps are performed using the PSH-Swager or SQ-101-SW.

NOTE

You must use 2 complete dies for each size.

CAUTION

Make sure both die halves are the same size and their serial numbers match. Failure to do so will result in an improperly

Hydraulic & Pneumatic Hose & Fit.

PTFE Hose & Fittings

Thermoplastic Tubing

Coiled Air Hose, Fittings & Accessories

Truck (Fleet) Products

Tooling & Equipment

Hose Accessories

Technical & Design Information

Approvals & Guides

Alphanumeric Index

Hydraulic & Pneumatic Hose & Fit.

PTFE Hose & Fittings

Thermoplastic Tubing

Coiled Air Hose, Fittings & Accessories

Truck (Fleet) Products

Tooling & Equipment

Hose Accessories

Technical & Design Information

Approvals & Guides

Alphanumeric Index

SEWER HOSE

11 ASSEMBLE HOSE

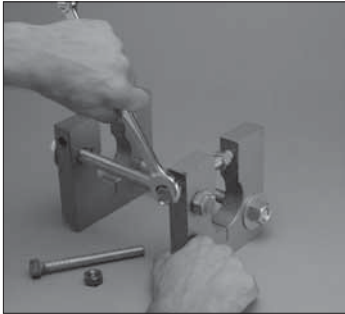

crimped fitting.

Remove both die securing bolts

14 ASSEMBLE HOSE

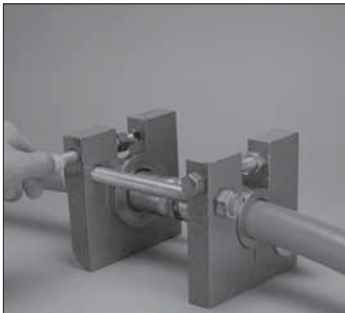

in each end of swager.

Install both die securing bolts with nuts positioned in opening of swager plates.

CAUTION

When swaging stainless steel fittings, lubricate through-hole of dies with Parker 702 Oil. Failure

12 ASSEMBLE HOSE

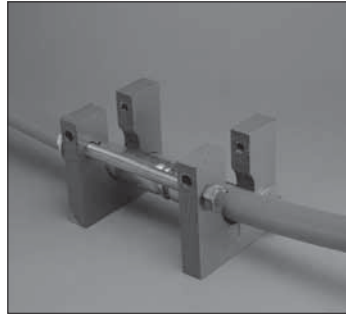

and nuts.

Place hose and fitting assembly

15 ASSEMBLE HOSE

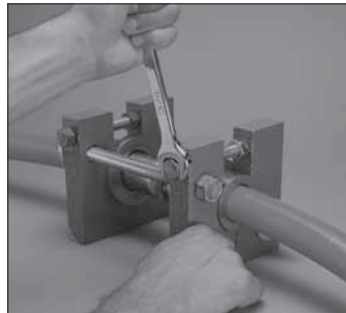

to do so may result in damage to fittings.

Tighten die securing bolts 1/4

13 ASSEMBLE HOSE

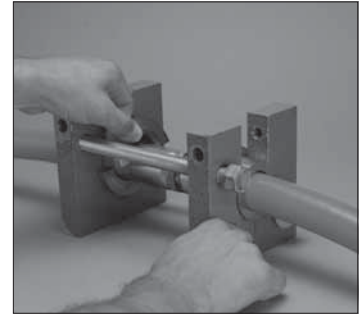

into position on swager.

Insert both die halves around hose

16 ASSEMBLE HOSE

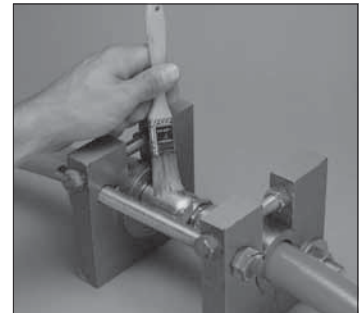

turn past finger tight.

Using a SAE 20 lubricating oil, generously lubricate fitting surface and I.D. of dies. (For stainless steel fittings, use Parker 702 Oil.)

CAUTION

Ensure swager plates remain in parallel when tightening swager bolts. Failure to do so will result in an improperly swaged fitting.

Generously Lubricate swaging bolts. Failure to do so may result in an improperly swaged fitting.

SEWER HOSE

17 ASSEMBLE HOSE

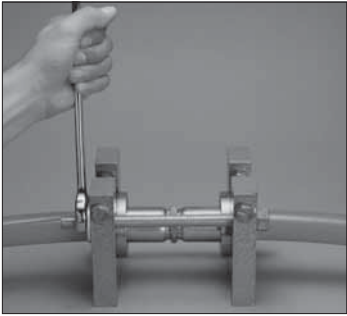

Align swager plates in parallel and tighten nuts on swaging bolts uniformly until dies touch.

18 ASSEMBLE HOSE

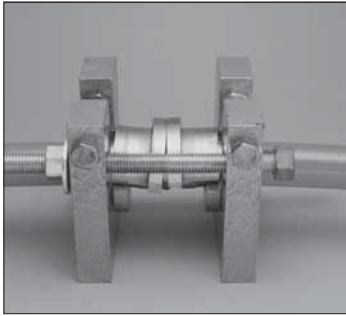

Loosen swaging bolts to release pressure on dies.

19 ASSEMBLE HOSE

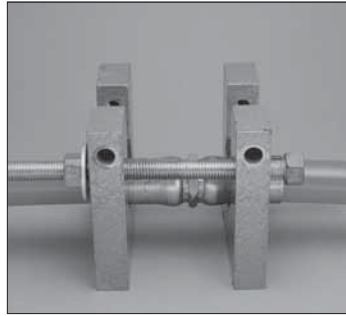

Remove die securing bolts and nuts, and remove dies.

20 ASSEMBLE HOSE

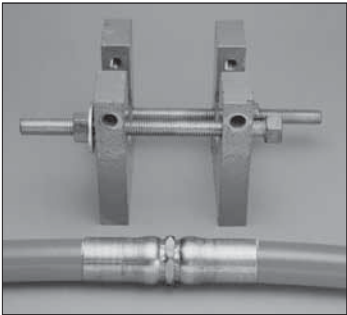

Lift out hose assembly.

21 MEASURE & INSPECT

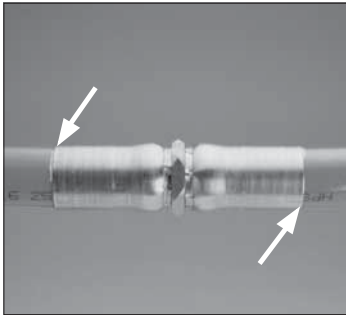

Inspect depth insertion mark at fitting ends. Insertion mark must be visible and within 1/8" of bottom of fitting shell.

22 MEASURE & INSPECT

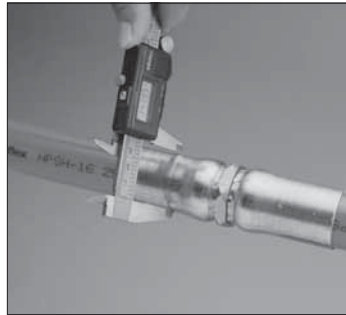

Measure swage diameter of each end of fitting at top, middle and bottom of shell. Take measurements at a minimum of three places around shell circumference. Verify swage diameter is within tolerances. (Refer to Swage Specification & Tool Selection Chart for proper swage diameters.)

23 MEASURE & INSPECT

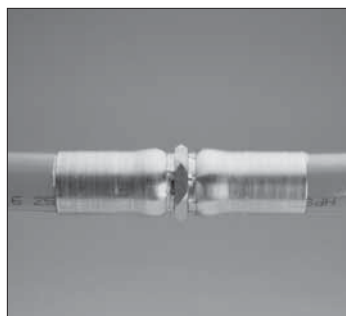

Pressure test hose if required.

SWAGER TOOLING

Part Number	Description
SQ-101-SW	Swager/Mender
SQ-101-12S6/S9	Size S612/S912 die
SQ-101-16S6	Size S616 die
SQ-101-16S9	Size S916 die
SQ-101-20S6	Size 20 die
SQ-101-12P	Size 12 pusher
SQ-101-16P	Size 16 pusher
SQ-101-20P	Size 20 pusher

S624, HFS212 & HFS216 cannot be swage mended.

55, 57, 58 and 91N

1 ASSEMBLE HOSE

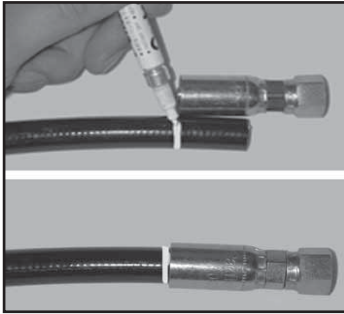

Place the hose next to the fitting and align it with the knurl marks in the fitting shell. Mark the length onto the hose. Push hose into the fitting until the mark on the hose is even with the end of the fitting shell (lubricate hose, if necessary).

2 ASSEMBLE HOSE



Select proper MiniKrimp die set. For Parflex hoses, see Parflex Hose Swage & Crimp Selection Chart in this catalog.)

3 ASSEMBLE HOSE

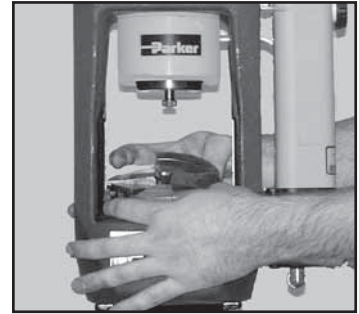

Place unitized die set into base plate.

4 ASSEMBLE HOSE



Place proper die ring on top of the selected die. See Parker PFD Catalog 4660 for proper die ring selection.

5 ASSEMBLE HOSE



Slide pusher into place onto shoulder bolt.

6 ASSEMBLE HOSE



Position the hose and fitting in dies from below.

55, 57, 58 and 91N

7 ASSEMBLE HOSE

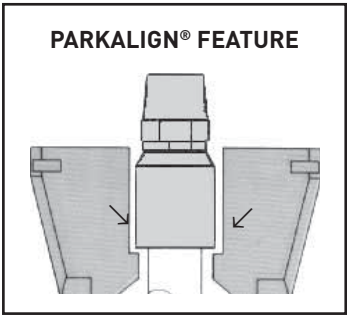

Rest bottom of coupling on die step using PARKALIGN® feature.

10 ASSEMBLE HOSE



Measure crimp diameter of each fitting at the top, middle and bottom of the shell. Take measurements at a minimum of three places around the shell circumference. Verify crimp diameter is within tolerances. [See Parflex Hose Swage & Crimp Selection Chart in this catalog.]

8 ASSEMBLE HOSE



While holding hose and fitting into position on die step, begin pumping hand pump until die ring contacts base plate.

NOTE:
Hose assemblies must be inspected for cleanliness and should be free of all foreign particles.

NOTE:
Parker Hannifin will not accept responsibility for the operation of, or provide warranty coverage for, a crimper that is operated by a power unit other than equipment supplied by Parker Hannifin for the express purpose of operating that crimper.

9 ASSEMBLE HOSE



Release pressure, remove finished assembly. Check crimp diameter. See Parker PFD Catalog 4660 for correct crimp diameter measurements.

Crimp Specification & Tool Selection Chart

Hose Type	Size	Ftg. Ser.	Crimp Die 80C-*83C-	Min. (in.)	Max. (in.)	Min. (mm)	Max. (mm)
510A	-2	57	P02H	0.396	0.410	10.0	10.4
510/510A	-3	55	P03	0.480	0.500	12.1	12.7
510/510A	-4	55	P04J	0.535	0.555	13.5	14.1
510A	-5	55	P05	0.620	0.640	15.7	16.3
510/510A	-6	55	P06	0.675	0.695	17.1	17.7
510A	-8	55	P08	0.840	0.860	21.3	21.9
510A	-12	55	P12	1.100	1.120	27.9	28.5
510/510A	-3	SU	P03	0.480	0.500	12.1	12.7
510/510A	-6	SU	P06	0.675	0.695	17.1	17.7
510A	-8	SU	P08	0.840	0.860	21.3	21.9
518C/510C	-2	57	P02H	0.396	0.410	10.0	10.4
518C/510C	-3	55	P03	0.480	0.500	12.1	12.7
518C/510C	-4	55	P04J	0.535	0.555	13.5	14.1
518C/510C	-5	55	P05	0.620	0.640	15.7	16.3
518C/510C	-6	55	P06	0.675	0.695	17.1	17.7
518C/510C	-8	55	P08	0.840	0.860	21.3	21.9
518C/510C	-10	58	P10H	1.000	1.020	25.4	26.0
518C/510C	-12	55	P12	1.100	1.120	27.9	28.5
518C/510C	-16	55	P16	1.345	1.365	34.1	34.7
520N/528N	-3	55	P03	0.480	0.500	12.1	12.7
520N/528N	-4	55	P04	0.560	0.580	14.2	14.8
520N/528N	-5	55	P05	0.620	0.640	15.7	16.3
520N/528N	-6	55	P06	0.675	0.695	17.1	17.7
520N/528N	-8	55	P08	0.840	0.860	21.3	21.9
520N/528N	-10	55	P10	0.950	0.970	24.1	24.7
526BA	-3	55	P03	0.480	0.500	12.1	12.7
526BA	-4	55	P04	0.560	0.580	14.2	14.8
526BA	-6	55	P06	0.675	0.695	17.1	17.7
540N	-2	57	P02H	0.396	0.410	10.0	10.4
540N	-3	55	P03	0.480	0.500	12.1	12.7
540N/540P	-4	55	P04	0.560	0.580	14.2	14.8
540N	-5	55	P05	0.620	0.640	15.7	16.3
540N/540P	-6	55	P06	0.675	0.695	17.1	17.7
540N/540P	-8	55	P08	0.840	0.860	21.3	21.9
540N/540P	-12	55	P12	1.100	1.120	27.9	28.5
540R	-4	55	P04	0.560	0.580	14.2	14.8
540N	-3	SU	P03	0.480	0.500	12.1	12.7
540N/540P	-6	SU	P06	0.675	0.695	17.1	17.7
540N/540P	-8	SU	P08	0.840	0.860	21.3	21.9
540N/540P	-12	HY	P12	1.100	1.120	27.9	28.5
549	-2	57	P02H	0.396	0.410	10.0	10.4
549	-3	55	P03	0.480	0.500	12.1	12.7
549	-4	55	P04	0.560	0.580	14.2	14.8
549	-5	55	P05	0.620	0.640	15.7	16.3
549	-6	55	P06	0.675	0.695	17.1	17.7
549	-8	55	P08	0.840	0.860	21.3	21.9
549	-12	55	P12	1.100	1.120	27.9	28.5
549	-3	SU	P03	0.480	0.500	12.1	12.7
549	-4	SU	P04J	0.535	0.555	13.5	14.1

Note: ** Black Die Ring must be used with these dies

Hose Type	Size	Ftg. Ser.	Crimp Die 80C-*83C-	Min. (in.)	Max. (in.)	Min. (mm)	Max. (mm)
549	-6	SU	P06	0.675	0.695	17.1	17.7
549	-8	SU	P08	0.840	0.860	21.3	21.9
55LT	-2	57	P02H	0.396	0.410	10.0	10.4
550H/55LT	-3	55	P03	0.480	0.500	12.1	12.7
550H/55LT	-4	55	P04	0.560	0.580	14.2	14.8
550H/55LT	-5	55	P05	0.620	0.640	15.7	16.3
550H/55LT	-6	55	P06	0.675	0.695	17.1	17.7
550H/55LT	-8	55	P08	0.840	0.860	21.3	21.9
550H/55LT	-12	55	P12	1.100	1.120	27.9	28.5
550H/55LT	-16	55	P16	1.345	1.365	34.1	34.7
550H/55LT	-10	58	P10H	1.000	1.020	25.4	26.0
550H/55LT	-3	SU	P03	0.480	0.500	12.1	12.7
550H/55LT	-4	SU	P04	0.560	0.580	14.2	14.8
550H/55LT	-5	SU	P05	0.620	0.640	15.7	16.3
550H/55LT	-6	SU	P06	0.675	0.695	17.1	17.7
550H/55LT	-8	SU	P08	0.840	0.860	21.3	21.9
550H/55LT	-12	HY	P12	1.100	1.120	27.9	28.5
55FR	-4	55	P04	0.560	0.580	14.2	14.8
55FR	-6	55	P06	0.675	0.695	17.1	17.7
55FR	-8	55	P08	0.840	0.860	21.3	21.9
55FR	-12	55	P12	1.100	1.120	27.9	28.5
55FR	-4	SU	P04	0.560	0.580	14.2	14.8
55FR	-6	SU	P06	0.675	0.695	17.1	17.7
55FR	-8	SU	P08	0.840	0.860	21.3	21.9
55FR	-12	HY	P12	1.100	1.120	27.9	28.5
83FR	-4	HY/55	P04J	.560	.580	14.2	14.7
83FR	-6	HY/55	P06	.675	.695	17.1	17.7
83FR	-8	HY/55	P08J	.815	.835	20.7	21.2
83FR	-12	HY/55	P12	1.100	1.120	27.9	28.4
560	-3	55	P03	0.480	0.500	12.1	12.7
560	-3	55	P03	0.480	0.500	12.1	12.7
560	-4	55	P04	0.560	0.580	14.2	14.8
560	-5	55	P05	0.620	0.640	15.7	16.3
560	-6	55	P06	0.675	0.695	17.1	17.7
560	-8	55	P08J	0.815	0.835	20.7	21.3
560	-10	55	P10	0.950	0.970	24.1	24.7
560	-12	58	P12H	1.150	1.170	29.2	29.8
563	-4	55	P04J	0.535	0.555	14.2	14.8
563	-6	55	P0715	0.675	0.695	17.1	17.7
563	-8	55	P0845	0.815	0.835	20.7	21.3
56DH/568DH	-1.5	SF	T03	0.295	0.315	7.50	8.00
56DH/568DH	-2	CY	P0368	0.361	0.375	9.17	9.53
575X	-3	55	P03	0.480	0.500	12.1	12.7
575X	-4	55	P04	0.560	0.580	14.2	14.8
575X	-6	55	P06	0.675	0.695	17.1	17.7
575X	-8	55	P08	0.840	0.860	21.3	21.9
575X	-12	58H	P1258H*	1.200	1.220	30.4	31.0

Note: * Silver Die Ring

Hydraulic & Pneumatic Hose & Fit.

PTFE Hose & Fittings

Thermoplastic Tubing

Coiled Air Hose, Fittings & Accessories

Truck (Fleet) Products

Tooling & Equipment

Hose Accessories

Technical & Design Information

Approvals & Guides

Alphanumeric Index



Crimp Specification & Tool Selection Chart

Hose Type	Size	Ftg. Ser.	Crimp Die 80C-*83C-	Min. (in)	Max. (in)	Min. (mm)	Max. (mm)
575X	-16	58H	P1658H*	1.605	1.625	40.7	41.3
575LH	-3	LH	LH3	0.450	0.470	11.4	12.0
580N/588N	-4	58	P04H	0.668	0.688	16.9	17.5
580N/588N	-6	58	P06H	0.785	0.805	19.9	20.5
580N/588N	-8	58	P08H	0.900	0.920	22.8	23.4
580N/588N	-10	58	P10H	1.000	1.020	25.4	26.0
580N/588N	-12	58	P12H	1.150	1.170	29.2	29.8
580N/588N	-16	58	P16H	1.475	1.495	37.4	38.0
H580N	-16	58H	P1658H*	1.605	1.625	40.7	41.3
53FR/530	-6	58	P06FR	0.730	0.750	18.5	19.1
53FR/530	-8	58	P08H	0.900	0.920	22.8	23.4
53FR/530	-12	58	P12H	1.150	1.170	29.2	29.8
573LH	-3	LV	LV3	0.423	0.443	10.7	11.3
590	-3	55	P03	0.480	0.500	12.1	12.7
590	-4	55	P04	0.560	0.580	14.2	14.8
590	-6	55	P06	0.675	0.695	17.1	17.7
590	-8	55	P08J	0.815	0.835	20.7	21.3
590	-10	58	P10H	1.000	1.020	25.4	26.0
590	-12	58	P12H	1.150	1.170	29.2	29.8
590	-16	58	P16J	1.450	1.470	36.8	37.4
593/FHN	-12	LV	P12L	1.150	1.170	29.2	29.8
593	-16	LV	P16L*	1.450	1.470	36.8	37.4
4PSH/S4	-8	58	P08H	0.900	0.920	22.8	23.4
4PSH/S4	-8	HY	P08H	0.900	0.920	22.8	23.4
PSH	-10	57	P10H	1.000	1.020	25.4	26.0
PSH/3PSH/HPSH	-12	57	P12H	1.150	1.170	29.2	29.8
PSH/3PSH/HPSH	-16	57	P16J	1.450	1.470	36.8	37.4
PSH	-10	58	P10H	1.000	1.020	25.4	26.0
PSH/3PSH/HPSH	-12	58	P12H	1.150	1.170	29.2	29.8
PSH/3PSH/HPSH	-16	58	P16J	1.450	1.470	36.8	37.4
PSH/3PSH/HPSH	-12	HY	P12H	1.150	1.170	29.2	29.8
PSH/3PSH/HPSH	-16	HY	P1490	1.480	1.500	37.5	38.1
MSH	-5	MS	M05	0.535	0.555	13.5	14.1
MSH	-6	MS	M06	0.640	0.660	16.2	16.8
MTH	-4	91N	MTH4	0.385	0.405	9.7	10.3
PTH	-3	92	T05	0.450	0.470	11.4	12.0
1035A/1035HT	-4	55	P04	0.560	0.580	14.2	14.8
1035A/1035HT	-6	55	P06	0.675	0.695	17.1	17.7
53LT/538LT	-3	55	P03	0.480	0.500	12.1	12.7
53LT/538LT	-4	55	P04	0.560	0.580	14.2	14.8
53LT/538LT	-5	58	P05R	0.650	0.670	16.5	17.1

Hose Type	Size	Ftg. Ser.	Crimp Die 80C-*83C-	Min. (in)	Max. (in)	Min. (mm)	Max. (mm)
53LT/538LT	-6	58	P06FR	0.730	0.750	18.5	19.1
53LT/538LT	-8	58	P08H	0.900	0.920	22.8	23.4
53LT/538LT	-10	58	P10H	1.000	1.020	25.4	26.0
53LT/538LT	-12	58H	P1258K*	1.260	1.280	32.0	32.6
53LT/538LT	-5	HY	P04H	0.668	0.688	16.9	17.5
53LT/538LT	-6	HY	P06FR	0.730	0.750	18.5	19.1
53LT/538LT	-8	HY	P08H	0.900	0.920	22.8	23.4
53LT/538LT	-3	SU	P03	0.480	0.500	12.1	12.7
GPH/GPV	-3	55	P03J	0.445	0.465	11.3	11.9
GPH/GPV	-4	55	P04J	0.535	0.555	13.5	14.1
GPH/GPV	-5	55	P05	0.620	0.640	15.7	16.3
GPH/GPV	-6	55	P06	0.675	0.695	17.1	17.7
GPH/GPV	-8	55	P08J	0.815	0.835	20.7	21.3
GPH/GPV	-10	55	P10	0.950	0.970	24.1	24.7
GPH/GPV	-12	55	P12	1.100	1.120	27.9	28.5
3CNG	-4	55	P04	0.560	0.580	14.2	14.8
3CNG	-6	58	P06H	0.785	0.805	19.9	20.5
4CNG	-6	58	P06H	0.785	0.805	19.9	20.5
5CNG/5CNGLT/5CNGFR	-3	55	P03	0.480	0.500	12.1	12.7
5CNG/5CNGLT/5CNGFR	-4	58	P04H	0.668	0.688	16.9	17.5
5CNG/5CNGLT/5CNGFR	-6	58	P06H	0.785	0.805	19.9	20.5
5CNG/5CNGLT/5CNGFR	-8	58	P08H	0.900	0.920	22.8	23.4
5CNG/5CNGLT/5CNGFR	-12	58H	P1258H*	1.200	1.220	30.4	31.0
5CNG/5CNGLT/5CNGFR	-16	58H	P1658H*	1.605	1.625	40.7	41.3
HGPH	-4	55	P04	0.560	0.580	14.2	14.8
GPH	-3	HBL	GPH3	0.390	0.410	9.9	10.5
GPH	-4	HBL	GPH4	0.490	0.510	12.4	13.0
GPH	-5	HBL	GPH5	0.560	0.580	14.2	14.8
GPH	-6	HBL	GPH6	0.625	0.645	15.8	16.4
GPH	-8	HBL	GPH8	0.750	0.770	19.0	19.6
GPH	-10	HBL	GPH10	0.895	0.915	22.7	23.3
GPH	-12	HBL	GPH12	1.060	1.080	26.9	27.5
GPH	-16	HBL	GPH16	1.335	1.355	33.9	34.5
D6	04	HY	P0580	0.570	0.590	14.4	15.0
D6	06	HY	P0740	0.730	0.750	18.5	19.1
D6	08	HY	P0870	0.860	0.880	21.8	22.4
D6	10	HY	P1045	1.035	1.055	26.2	26.8

Note: ** Black Die Ring must be used with these dies

Note: * Silver Die Ring



Hydraulic & Pneumatic Hose & Fit.
PTFE Hose & Fittings
Thermoplastic Tubing
Coiled Air Hose, Fittings & Accessories
Truck (Fleet) Products
Tooling & Equipment
Hose Accessories
Technical & Design Information
Approvals & Guides
Alphanumeric Index

Crimp Specification & Tool Selection Chart

Hose Type	Size	Ftg. Ser.	Crimp Die 80C-*83C-	Min. (in)	Max. (in)	Min. (mm)	Max. (mm)
D6	12	HY	P1220	1.210	1.230	30.7	31.3
D6	16	HY	P1525	1.515	1.535	38.4	39.0
H6	04	HY	P0550	0.540	0.560	13.7	14.3
H6	05	HY	P0635	0.625	0.645	15.8	16.4
H6	06	HY	P0705	0.695	0.715	17.6	18.2
H6	08	HY	P0845	0.835	0.855	21.2	21.8
H6	10	HY	P1045	1.035	1.055	26.2	26.8
H6	12	HY	P1195	1.185	1.205	30.1	30.7
HFS/HR1C	04	HY	P0580	0.570	0.590	14.4	15.0
HFS	05	HY	P0665	0.655	0.675	16.6	17.2
HFS/HR1C	06	HY	P0740	0.730	0.750	18.5	19.1
HFS/HR1C	08	HY	P0845	0.835	0.855	21.2	21.8
HFS	12	HY	P1130	1.120	1.140	28.4	29.0
HFS	16	HY	P1395	1.385	1.405	35.1	35.7
HFS2/HR2C	04	HY	P0625	0.615	0.635	15.6	16.2
HFS2/HR2C	06	HY	P0740	0.730	0.750	18.5	19.1
HFS2/HR2C	08	HY	P0870	0.860	0.880	21.8	22.4
HFS2/HR2C	10	HY	P1015	1.005	1.025	25.5	26.1
HFS2/HR2C	12	HY	P1150	1.140	1.160	28.9	29.5
HFS2/HR2C	16	HY	P1450	1.440	1.460	36.5	37.1
HLB	2	CY	80C-P0368	0.361	0.375	9.2	9.5
HLB	3	CY	80C-P0505	0.495	0.515	12.6	13.1
R6	04	HY	P0570	0.560	0.580	14.2	14.8
R6	06	HY	P0740	0.730	0.750	18.5	19.1
R6	08	HY	P0870	0.860	0.880	21.8	22.4
R6	10	HY	P1100	1.090	1.110	27.6	28.2

Hose Type	Size	Ftg. Ser.	Crimp Die 80C-*83C-	Min. (in)	Max. (in)	Min. (mm)	Max. (mm)
R6	12	HY	P1245	1.235	1.255	31.3	31.9
R6	16	43	M1600	1.590	1.610	40.3	40.9
S5	08	55	P08	0.840	0.860	21.3	21.9
S5	10	58	P10S	1.060	1.080	26.9	27.5
S6	12	58	P12H	1.150	1.170	29.2	29.8
S6	16	58	P16J	1.450	1.470	36.8	37.4
S6	24	71	-	2.290	2.310	58.1	58.7
S6	12	HY	P12H	1.150	1.170	29.2	29.8
S6	16	HY	P1450	1.440	1.460	36.5	37.1
S6	20	SQ	T24*	1.840	1.860	46.7	47.3
S9	12	58	P12H	1.150	1.170	29.2	29.8
S9	16	58	P16J	1.450	1.470	36.8	37.4
S9	12	HY	P12H	1.150	1.170	29.2	29.8
S9	16	HY	P1490	1.480	1.500	37.5	38.1
HTB	04	BW	P0745*	0.735	0.755	18.6	19.2
HTB	06	43	A06**	0.865	0.885	21.9	22.5
HTB	08	43	A08**	0.985	1.005	25.0	25.6
HTB	10	43	A10**	1.100	1.120	27.9	28.5
HTB	12	43	A12**	1.285	1.305	32.6	33.2
HTB	16	43	A16**	1.630	1.650	41.4	42.0
M8	06	43	M0850	0.840	0.860	21.3	21.9
M8	08	43	M1010	1.000	1.020	25.4	26.0
M8	10	43	M1170	1.160	1.180	29.4	30.0

Note: ** Black Die Ring must be used with these dies

Note: * Silver Die Ring

Notes:

1. Crimp diameter roundness shall not vary by more than .010".
2. Crimp diameters are measured in the center to the crimp area.
3. Use only Silver Die Ring when crimping Parflex hose fittings except where noted above.
4. Parflex Division reserves the right to alter crimp specifications.

Crimp Specification & Tool Selection Chart

Hose Type	Size	Fitting Series	Crimp Die	Crimp Ring	Crimp Diameter			
					Min. (in)	Max. (in)	Min. (mm)	Max. (mm)
919	-3	91	80C-T03	(SILVER)*	0.295	0.305	7.49	7.75
919/919U/901N/919B	-4	91N	80C-T04N	(SILVER)*	0.335	0.355	8.51	9.02
919/919B	-5	91N	80C-T05N	(SILVER)*	0.385	0.405	9.78	10.29
919/919U/919B	-6	91N	80C-T06N	(SILVER)*	0.470	0.490	11.94	12.45
919/919U/919B	-8	91N	80C-T08N	(SILVER)*	0.565	0.585	14.35	14.86
919/919B	-10	91N	80C-T10N	(SILVER)*	0.665	0.685	16.89	17.40
919/919U/919B	-12	91N	80C-T12N	(SILVER)*	0.790	0.810	20.07	20.57
919/919U/919B	-16	91N	80C-T16N	(SILVER)*	1.045	1.065	26.54	27.05
919	-20	91	80C-T20	(SILVER)*	1.415	1.435	35.94	36.45
929/929B	-4	91N	80C-T04N	(SILVER)*	0.335	0.355	8.51	9.02
929/929B	-5	91N	80C-T05N	(SILVER)*	0.385	0.405	9.78	10.29
929/929B	-6	91N	80C-T06N	(SILVER)*	0.470	0.490	11.94	12.45
929/929B	-8	91N	80C-T08N	(SILVER)*	0.565	0.585	14.35	14.86
929/929B	-10	91N	80C-T10N	(SILVER)*	0.665	0.685	16.89	17.40
929/929B	-12	91N	80C-T12N	(SILVER)*	0.790	0.810	20.07	20.57
929/929B	-16	91N	80C-T16H	(SILVER)*	1.100	1.120	27.94	28.45
929BJ	-4	91N	80C-T04J	(SILVER)*	0.335	0.355	8.51	9.02
929BJ	-5	91N	80C-T05J	(SILVER)*	0.385	0.405	9.78	10.29
929BJ	-6	91N	80C-T06J	(SILVER)*	0.470	0.490	11.94	12.45
929BJ	-8	91N	80C-T08J	(SILVER)*	0.565	0.585	14.35	14.86
929BJ	-10	91N	80C-T10J	(SILVER)*	0.665	0.685	16.89	17.40
929BJ	-12	91N	80C-T12J	(SILVER)*	0.790	0.810	20.07	20.57
929BJ	-16	91N	80C-T16HJ	(SILVER)*	1.100	1.120	27.94	28.45
919J	-4	91N	80C-T04J	(SILVER)*	0.335	0.355	8.51	9.02
919J	-5	91N	80C-T05J	(SILVER)*	0.385	0.405	9.78	10.29
919J	-6	91N	80C-T06J	(SILVER)*	0.470	0.490	11.94	12.45
919J	-8	91N	80C-T08J	(SILVER)*	0.565	0.585	14.35	14.86
919J	-10	91N	80C-T10J	(SILVER)*	0.665	0.685	16.89	17.40
919J	-12	91N	80C-T12J	(SILVER)*	0.790	0.810	20.07	20.57
919J	-16	91N	80C-T16J	(SILVER)*	1.045	1.065	26.54	27.05
939/939B	-6	93N	80C-P04	(SILVER)*	0.560	0.580	14.22	14.73
939/939B	-8	93N	83C-T08	(SILVER)*	0.750	0.770	19.05	19.56
939/939B	-10	93N	83C-T10	(SILVER)*	0.910	0.930	23.11	23.62
939/939B/939BU	-12	93N	83C-T12	(SILVER)*	1.090	1.110	27.69	28.19
939/939B/939BK †	-16	93N	83C-T16	(SILVER)*	1.295	1.315	32.89	33.40
939/939B †	-20	93N	83C-T20	None*	1.580	1.600	40.13	40.64
939/939B †	-24	93N	83C-T24	None*	1.845	1.865	46.86	47.37
939/939B †	-32	93N	83C-T32	None*	2.410	2.430	61.21	61.72

*The Parkrimp 2 and SuperKrimp always use the integral silver ring. 91N series may be crimped on the Parkrimp 2 and SuperKrimp if adapter bowl 83C-0CB is used.
 † Must use Parkrimp 2 and Supercrimp.

Notes:

1. Crimp diameter roundness shall not vary by more than .010".
2. Crimp diameters are measured in the center to the crimp area.
3. Use only Silver Die Ring when crimping Parflex hose fittings except where noted above.
4. Parflex Division reserves the right to alter crimp specifications.



Hydraulic & Pneumatic Hose & Fit.
 PTFE Hose & Fittings
 Thermoplastic Tubing
 Coiled Air Hose, Fittings & Accessories
 Truck (Fleet) Products
 Tooling & Equipment
 Hose Accessories
 Technical & Design Information
 Approvals & Guides
 Alphanumeric Index

Swage Specification & Tool Selection Chart

Hose Type	Size	Fitting Series	Swage Die DIE-	Swage Diameter			
				Min. (in.)	Max. (in.)	Min. (mm)	Max. (mm)
GPH	-3	55	J03	0.445	0.465	11.3	11.8
GPH	-4	55	J04	0.535	0.555	13.6	14.1
GPH	-5	55	305	0.620	0.640	15.7	16.3
GPH	-6	55	306	0.675	0.695	17.1	17.7
GPH	-8	55	J08	0.815	0.835	20.7	21.2
GPH	-10	55	310	0.950	0.970	24.1	24.6
GPH	-12	55	312	1.100	1.120	27.9	28.4
520N/528N	-3	55	303	0.480	0.500	12.2	12.7
520N/528N	-4	55	304	0.560	0.580	14.2	14.7
520N/528N	-5	55	305	0.620	0.640	15.7	16.3
520N/528N	-6	55	306	0.675	0.695	17.1	17.7
520N/528N	-8	55	308	0.840	0.860	21.3	21.8
526BA	-3	55	303	0.480	0.500	12.2	12.7
526BA	-4	55	304	0.560	0.580	14.2	14.7
526BA	-6	55	306	0.675	0.695	17.1	17.7
540N	-3	55/SU	303	0.480	0.500	12.2	12.7
540N/540P	-4	55	304	0.560	0.580	14.2	14.7
540N	-5	55	305	0.620	0.640	15.7	16.3
540N/540P	-6	55/SU	306	0.675	0.695	17.1	17.7
540N/540P	-8	55/SU	308	0.840	0.860	21.3	21.8
540N/540P	-12	55	312	1.100	1.120	27.9	28.4
549	-3	55/SU	303	0.480	0.500	12.2	12.7
549	-4	55	304	0.560	0.580	14.2	14.7
549	-4	SU	J04	0.535	0.555	13.6	14.1
549	-5	55	305	0.620	0.640	15.7	16.3
549	-6	55/SU	306	0.675	0.695	17.1	17.7
549	-8	55/SU	308	0.840	0.860	21.3	21.8
549	-12	55	312	1.100	1.120	27.9	28.4
550A/550H/55LT	-3	55	303	0.480	0.500	12.2	12.7
550A/550H/55LT	-4	55	304	0.560	0.580	14.2	14.7
550H/55LT	-5	55	305	0.620	0.640	15.7	16.3
550A/550H/55LT	-6	55	306	0.675	0.695	17.1	17.7
550A/550H/55LT	-8	55	308	0.840	0.860	21.3	21.8
550H/55LT	-10	58	H10	1.000	1.020	25.4	25.9
550H/55LT	-12	55	312	1.100	1.120	27.9	28.4
550H/55LT	-16	55	316	1.345	1.365	34.2	34.7
55FR	-4	55/SU	304	0.560	0.580	14.2	14.7
55FR	-6	55/SU	306	0.675	0.695	17.1	17.7
55FR	-8	55/SU	308	0.840	0.860	21.3	21.8
55FR	-12	55	312	1.100	1.120	27.9	28.4
580N/588N	-4	58	H04	0.668	0.688	17.0	17.5
580N/588N	-6	58	H06	0.785	0.805	19.9	20.4
580N/588N	-8	58	H08	0.900	0.920	22.9	23.4
580N/588N	-10	58	H10	1.000	1.020	25.4	25.9
580N/588N	-12	58	H12	1.150	1.170	29.2	29.7
580N/588N	-16	58	H16	1.475	1.495	37.5	38.0

Hose Type	Size	Fitting Series	Swage Die DIE-	Swage Diameter			
				Min. (in.)	Max. (in.)	Min. (mm)	Max. (mm)
53FR/530	-8	58	H08	0.900	0.920	22.9	23.4
53FR/530	-12	58	H12	1.150	1.170	29.2	29.7
560	-3	55	303	0.480	0.500	12.2	12.7
560	-4	55	304	0.560	0.580	14.2	14.7
560	-5	55	305	0.620	0.640	15.7	16.3
560	-6	55	306	0.675	0.695	17.1	17.7
560	-8	55	J08	0.815	0.835	20.7	21.2
560	-10	55	310	0.950	0.970	24.1	24.6
560	-12	58	H12	1.150	1.170	29.2	29.7
573X/XL	-3	LV	V03	0.423	0.443	10.7	11.3
573X	-16	LV	J16	1.450	1.470	36.8	37.3
573LH	-3	LV	V03	0.423	0.443	10.7	11.3
575LH	-3	LH	V03X	0.450	0.470	11.4	11.9
580N/588N	-4	58	H04	0.668	0.688	16.9	17.5
580N/588N	-6	58	H06	0.785	0.805	19.9	20.5
580N/588N	-8	58	H08	0.900	0.920	22.8	23.4
580N/588N	-10	58	H10	1.000	1.020	25.4	26.0
580N/588N	-12	58	H12	1.150	1.170	29.2	29.8
580N/588N	-16	58	H16	1.475	1.495	37.4	38.0
H580N	-16	58H		1.605	1.625	40.7	41.3
590	-3	58	303	0.480	0.500	12.2	12.7
590	-4	55	304	0.560	0.580	14.2	14.7
590	-6	55	306	0.675	0.695	17.1	17.7
590	-8	55	J08	0.815	0.835	20.7	21.2
590	-10	58	H10	1.000	1.020	25.4	25.9
590	-12	58	H12	1.150	1.170	29.2	29.7
590	-16	58	J16	1.450	1.470	36.8	37.3
593/FHN	-12	LV	H12	1.150	1.170	29.2	29.7
593	-16	LV	J16	1.450	1.470	36.8	37.3
4PSH/S4	-8	58	H08	0.900	0.920	22.9	23.4
PSH	-10	58	H10	1.000	1.020	25.4	25.9
PSH/3PSH/S6/S9	-12	58	H12	1.150	1.170	29.2	29.7
PSH/HPSH/3PSH/S6	-16	58	J16	1.440	1.460	36.6	37.1
MSH	-5	MS	M05	0.535	0.555	13.6	14.1
MSH	-6	MS	M06	0.640	0.660	16.3	16.8
MTH	-4	91N	MTH4	0.385	0.405	9.7	10.3
PTH	-3	92	T10090-5	0.450	0.470	11.4	11.9
510A	-3	55/SU	303	0.480	0.500	12.2	12.7
510A	-4	55	J04	0.535	0.555	13.6	14.1
510A	-6	55/SU	306S	0.675	0.695	17.1	17.7
510A	-8	55/SU	308	0.840	0.860	21.3	21.8
518C/510C	-3	55	303	0.480	0.500	12.2	12.7
518C/510C	-4	55	J04	0.535	0.555	13.6	14.1
518C/510C	-5	55	305	0.620	0.640	15.7	16.3
518C/510C	-6	55	306	0.675	0.695	17.1	17.7
518C/510C	-8	55	308	0.840	0.860	21.3	21.8

Swage Specification & Tool Selection Chart

Hose Type	Size	Fitting Series	Swage Die DIE-	Swage Diameter			
				Min. (in)	Max. (in)	Min. (mm)	Max. (mm)
518C/510C	-10	58	H10	1.000	1.020	25.4	25.9
518C/510C	-12	55	312	1.100	1.120	27.9	28.4
518C/510C	-16	55	316	1.345	1.365	34.2	34.7
53LT/538LT	-3	55/SU	303	0.480	0.500	12.2	12.7
53LT/538LT	-4	55	304	0.560	0.580	14.2	14.7
53LT/538LT	-5	58	R05	0.650	0.670	16.5	17.0
53LT/538LT	-6	58	FR06	0.730	0.750	18.5	19.1
53LT/538LT	-10	58	H10	1.000	1.020	25.4	25.9
575X	-3	55	303	0.480	0.500	12.2	12.7
575X	-4	55	304	0.560	0.580	14.2	14.7
575X	-6	55	306	0.675	0.695	17.1	17.7
575X	-8	55	308	0.840	0.860	21.3	21.8
1035A	-4	55	304	0.560	0.580	14.2	14.7
1035A	-6	55	306	0.675	0.695	17.1	17.7
3CNG/3CNGLT/ 3CNGFR	-4	55	304	0.560	0.580	14.2	14.7
3CNG/3CNGLT/ 3CNGFR	-6	58	H06	0.785	0.805	19.9	20.4
4CNG/5CNGLT/ 4CNGFR	-6	58	H06	0.785	0.805	19.9	20.4
5CNG/5CNGLT/ 5CNGFR	-3	55	303	0.480	0.500	12.2	12.7
5CNG/5CNGLT/ 5CNGFR	-4	58	H04	0.668	0.688	17.0	17.5
5CNG/5CNGLT/ 5CNGFR	-6	58	H06	0.785	0.805	19.9	20.4
5CNG/5CNGLT/ 5CNGFR	-8	58	H08	0.900	0.920	22.9	23.4

Notes:

1. The information covered in the Swage Specification & Tool Selection Chart pertains to steel, stainless and brass hose fittings.
2. Swage diameter roundness shall not vary by more than .010".
3. Swage diameters are measured in the center to the crimp area.
4. Parflex Division reserves the right to alter swage specifications.

Hydraulic & Pneumatic Hose & Fit.

PTFE Hose & Fittings

Thermoplastic Tubing

Coiled Air Hose, Fittings & Accessories

Truck (Fleet) Products

Tooling & Equipment

Hose Accessories

Technical & Design Information

Approvals & Guides

Alphanumeric Index



Swage and Crimp Die Selection Chart

Hose Type	Size	Fitting Series	Swage Die DIE-	Crimp Die 80C-*83C-	Machine Selection		Color Code
					Brass Steel	Stainless Steel	
510A	-2	57	-	P02H	A	A	BROWN
510/510A	-3	55	303	P03	A	A	GRAY
510/510A	-4	55	J04	P04J	A	A	RED
510A	-5	55	-	P05	A	A	PURPLE
510/510A	-6	55	306	P06	A	A	YELLOW
510A	-8	55	308	P08	A	A	BLUE
510A	-12	55	-	P12	A	A	GREEN
510/510A	-3	SU	303	P03	A	A	GRAY
510/510A	-6	SU	306	P06	A	A	YELLOW
510A	-8	SU	308	P08	A	A	BLUE
518C/510C	-2	57	-	P02H	A	A	BROWN
518C/510C	-3	55	303	P03	A	A	GRAY
518C/510C	-4	55	J04	P04J	A	A	RED
518C/510C	-5	55	305	P05	A	A	PURPLE
518C/510C	-6	55	306	P06	A	A	YELLOW
518C/510C	-8	55	308	P08	A	A	BLUE
518C/510C	-10	58	H10	P10H	A	A	ORANGE
518C/510C	-12	55	312	P12	A	A	GREEN
518C/510C	-16	55	316	P16	A	A	BLACK
520N/528N	-3	55	303	P03	A	A	GRAY
520N/528N	-4	55	304	P04	A	A	RED
520N/528N	-5	55	305	P05	A	A	PURPLE
520N/528N	-6	55	306	P06	A	A	YELLOW
520N/528N	-8	55	308	P08	A	A	BLUE
520N/528N	-10	55	-	P10	A	A	ORANGE
526BA	-3	55	303	P03	A	A	GRAY
526BA	-4	55	304	P04	A	A	RED
526BA	-6	55	306	P06	A	A	YELLOW
540N	-2	57	H02	P02H	A	A	BROWN
540N	-3	55	303	P03	A	A	GRAY
540N/540P	-4	55	304	P04	A	A	RED
540N	-5	55	305	P05	A	A	PURPLE
540N/540P	-6	55	306	P06	A	A	YELLOW
540N/540P	-8	55	308	P08	A	A	BLUE
540N/540P	-12	55	312	P12	A	A	GREEN
540N	-3	SU	303	P03	A	A	GRAY
540N/540P	-6	SU	306	P06	A	A	YELLOW
540N/540P	-8	SU	308	P08	A	A	BLUE
540N/540P	-12	HY	-	P12	A	A	GREEN
549	-2	57	-	P02H	A	A	BROWN
549	-3	55	303	P03	A	A	GRAY
549	-4	55	304	P04	A	A	RED
549	-5	55	305	P05	A	A	PURPLE
549	-6	55	306	P06	A	A	YELLOW
549	-8	55	308	P08	A	A	BLUE
549	-12	55	312	P12	A	A	GREEN
549	-4	SU	J04	P04J	A	A	RED
549	-6	SU	306	P06	A	A	YELLOW
83FR	-4	HY/55		P04J	A	A	RED
83FR	-6	HY/55		P06	A	A	YELLOW
83FR	-8	HY/55		P08J	A	A	BLUE
83FR	-12	HY/55		P12	A	A	GREEN

* See "Crimp Specification and Tool Selection Chart" in this catalog for the proper die ring for these hose sizes. All other hoses use the SILVER RING only.
 † Crimp Machine Code: A = All models; B = Parkrimp II and Superkrimp only.



Hydraulic & Pneumatic Hose & Fit.
 PTFE Hose & Fittings
 Thermoplastic Tubing
 Coiled Air Hose, Fittings & Accessories
 Truck (Fleet) Products
 Tooling & Equipment
 Hose Accessories
 Technical & Design Information
 Approvals & Guides
 Alphanumeric Index

Swage and Crimp Die Selection Chart

Hose Type	Size	Fitting Series	Swage Die DIE-	Crimp Die 80C-*83C-	Machine Selection		Color Code
					Brass	Stainless	
549	-8	SU	308	P08	A	A	BLUE
55LT	-2	57	-	P02H	A	A	BROWN
550H/55LT	-3	55	303	P03	A	A	GRAY
550H/55LT	-4	55	304	P04	A	A	RED
550H/55LT	-5	55	305	P05	A	A	PURPLE
550H/55LT	-6	55	306	P06	A	A	YELLOW
550H/55LT	-8	55	308	P08	A	A	BLUE
550H/55LT	-12	55	312	P12	A	A	GREEN
550H/55LT	-16	55	316	P16	A	A	BLACK
550H/55LT	-10	58	H10	P10H	A	A	ORANGE
550H/55LT	-3	SU	303	P03	A	A	GRAY
550H/55LT	-4	SU	304	P04	A	A	RED
550H/55LT	-5	SU	305	P05	A	A	PURPLE
550H/55LT	-6	SU	306	P06	A	A	YELLOW
550H/55LT	-8	SU	308	P08	A	A	BLUE
550H/55LT	-12	HY	312	P12	A	A	GREEN
55FR	-4	55	304	P04	A	A	RED
55FR	-6	55	306	P06	A	A	YELLOW
55FR	-8	55	308	P08	A	A	BLUE
55FR	-12	55	312	P12	A	A	GREEN
55FR	-4	SU	304	P04	A	A	RED
55FR	-6	SU	306	P06	A	A	YELLOW
55FR	-8	SU	308	P08	A	A	BLUE
55FR	-12	HY	312	P12	A	A	GREEN
560	-3	55	303	P03	A	A	GRAY
560	-4	55	304	P04	A	A	RED
560	-5	55	305	P05	A	A	PURPLE
560	-6	55	306	P06	A	A	YELLOW
560	-8	55	J08	P08J	A	A	BLUE
560	-10	55	310	P10	A	A	ORANGE
560	-12	58	H12	P12H	A	A	GREEN
563	-4	55	-	P04J	A	A	RED
563	-6	55	-	P0715	A	A	YELLOW
563	-8	55	-	P0845	A	A	BLUE
56DH/568DH	-1.5	SF	-	T03	A	A	Gray
56DH/568DH	-2	CY	-	P0368	A	A	BROWN
575X	-3	55	303	P03	A	A	GRAY
575X	-4	55	304	P04	A	A	RED
575X	-6	55	306	P06	A	A	YELLOW
575X	-8	55	308	P08	A	A	BLUE
575X	-12	58H	-	P1258H*	B	B	GREEN
575X	-16	58H	-	P1658H*	B	B	BLACK
575LH	-3	LH	V03X	LH3	A	A	GRAY
580N/588N	-4	58	H04	P04H	A	A	RED
580N/588N	-6	58	H06	P06H	A	A	YELLOW
580N/588N	-8	58	H08	P08H	A	A	BLUE
580N/588N	-10	58	H10	P10H	A	A	ORANGE

* See "Crimp Specification and Tool Selection Chart" in this catalog for the proper die ring for these hose sizes. All other hoses use the SILVER RING only.
 † Crimp Machine Code: A = All models; B = Parkrimp II and Superkrimp only.



Hydraulic & Pneumatic Hose & Fit.
 PTFE Hose & Fittings
 Thermoplastic Tubing
 Coiled Air Hose, Fittings & Accessories
 Truck (Fleet) Products
 Tooling & Equipment
 Hose Accessories
 Technical & Design Information
 Approvals & Guides
 Alphanumeric Index

Swage and Crimp Die Selection Chart

Hose Type	Size	Fitting Series	Swage Die DIE-	Crimp Die 80C-*83C-	Machine Selection		Color Code
					Brass Steel	Stainless Steel	
580N/588N	-12	58	H12	P12H	A	A	GREEN
580N/588N	-16	58	H16	P16H	A	B	BLACK
H580N	-16	58H	-	P1658H*	B	B	BLACK
53FR/530	-6	58	FR06	P06FR	A	A	YELLOW
53FR/530	-8	58	H08	P08H	A	A	BLUE
53FR/530	-12	58	H12	P12H	A	A	GREEN
573LH	-3	LV	V03	LV3	A	A	GRAY
590	-3	55	303	P03	A	A	GRAY
590	-4	55	304	P04	A	A	RED
590	-6	55	306	P06	A	A	YELLOW
590	-8	55	J08	P08J	A	A	BLUE
590	-10	58	H10	P10H	A	B	ORANGE
590	-12	58	H12	P12H	A	B	GREEN
590	-16	58	J16	P16J	A	B	BLACK
593/FHN	-12	LV	H12	P12L	B	B	GREEN
593	-16	LV	J16	P16L*	B	B	BLACK
4PSH/S4	-8	57H	-	P08H	A	A	BLUE
4PSH/S4	-8	58	H08	P08H	A	A	BLUE
4PSH/S4	-8	HY	-	P08H	A	A	BLUE
PSH	-10	57	-	P10H	A	A	ORANGE
PSH/3PSH/HPSH	-12	57	-	P12H	A	A	GREEN
PSH/3PSH/HPSH	-16	57	-	P16J	A	B	BLACK
PSH	-10	58	H10	P10H	A	A	ORANGE
PSH/3PSH/HPSH	-12	58	H12	P12H	A	A	GREEN
PSH/3PSH/HPSH	-16	58	J16	P16J	A	B	BLACK
PSH/3PSH/HPSH	-12	HY	-	P12H	A	A	GREEN
PSH/3PSH/HPSH	-16	HY	-	P1490	A	B	BLACK
MSH	-5	MS	M05	M05	A	A	PURPLE
MSH	-6	MS	M06	M06	A	A	YELLOW
MTH	-4	91N	-	MTH4	A	A	RED
PTH	-3	92	T10090-5	T05	A	A	PURPLE
1035HT	-3	55	303	P03	A	A	GRAY
1035A/1035HT	-4	55	304	P04	A	A	RED
1035A/1035HT	-6	55	306	P06	A	A	YELLOW
53LT/538LT	-3	55	303	P03	A	A	GRAY
53LT/538LT	-4	55	304	P04	A	A	RED
53LT/538LT	-5	58	R05	P05R	A	A	PURPLE
53LT/538LT	-6	58	FR06	P06FR	A	A	YELLOW
53LT/538LT	-8	58	H08	P08H	A	A	BLUE
53LT/538LT	-10	58	H10	P10H	A	A	ORANGE
53LT/538LT	-12	58H	-	P1258K*	B	B	GREEN
53LT/538LT	-5	HY	R05	P04H	A	A	RED
53LT/538LT	-6	HY	FR06	P06FR	A	A	YELLOW
53LT/538LT	-8	HY	H08	P08H	A	A	BLUE
GPH/GPV	-3	55	J03	P03J	A	A	GRAY
GPH/GPV	-5	55	305	P05	A	A	PURPLE
GPH/GPV	-6	55	306	P06	A	A	YELLOW
GPH/GPV	-8	55	J08	P08J	A	A	BLUE

* See "Crimp Specification and Tool Selection Chart" in this catalog for the proper die ring for these hose sizes. All other hoses use the SILVER RING only.
 † Crimp Machine Code: A = All models; B = Parkrimp II and Superkrimp only.



Hydraulic & Pneumatic Hose & Fit.

PTFE Hose & Fittings

Thermoplastic Tubing

Coiled Air Hose, Fittings & Accessories

Truck (Fleet) Products

Tooling & Equipment

Hose Accessories

Technical & Design Information

Approvals & Guides

Alphanumeric Index

Swage and Crimp Die Selection Chart

Hose Type	Size	Fitting Series	Swage Die DIE-	Crimp Die 80C-*83C-	Machine Selection		Color Code
					Brass Steel	Stainless Steel	
GPH/GPV	-10	55	310	P10	A	A	ORANGE
GPH/GPV	-12	55	312	P12	A	A	GREEN
3CNG	-4	55	304	P04	A	A	RED
3CNG	-6	58	H06	P06H	A	A	YELLOW
4CNG	-6	58	H06	P06H	A	A	RED
5CNG/5CNGLT/5CNGFR	-3	55	303	P03	A	A	GRAY
5CNG/5CNGLT/5CNGFR	-4	58	H04	P04H	A	A	RED
5CNG/5CNGLT/5CNGFR	-6	58	H06	P06H	A	A	YELLOW
5CNG/5CNGLT/5CNGFR	-8	58	H08	P08H	A	A	BLUE
5CNG/5CNGLT/5CNGFR	-12	58H	-	P1258H*	B	B	GREEN
5CNG/5CNGLT/5CNGFR	-16	58H	-	P1658H*	B	B	BLACK
HGPH	-4	55	-	P04	A	A	GRAY
GPH	-3	HBL	-	GPH3	A	A	GRAY
GPH	-4	HBL	-	GPH4	A	A	RED
GPH	-5	HBL	-	GPH5	A	A	PURPLE
GPH	-6	HBL	-	GPH6	A	A	YELLOW
GPH	-8	HBL	-	GPH8	A	A	BLUE
GPH	-10	HBL	-	GPH10	A	A	ORANGE
GPH	-12	HBL	-	GPH12	A	A	GREEN
GPH	-16	HBL	-	GPH16	A	A	BLACK
D6	04	HY	-	P0580	A	A	RED
D6	06	HY	-	P0740	A	A	YELLOW
D6	08	HY	-	P0870	A	A	BLUE
D6	10	HY	-	P1045	A	A	ORANGE
D6	12	HY	-	P1220	A	A	GREEN
D6	16	HY	-	P1525	A	A	BLACK
H6	04	HY	-	P0550	A	A	RED
H6	05	HY	-	P0635	A	A	PURPLE
H6	06	HY	-	P0705	A	A	YELLOW
H6	08	HY	-	P0845	A	A	BLUE
H6	10	HY	-	P1045	A	A	ORANGE
H6	12	HY	-	P1195	A	A	GREEN
HFS/HR1C	04	HY	-	P0580	A	A	RED
HFS	05	HY	-	P0665	A	A	PURPLE
HFS/HR1C	06	HY	-	P0740	A	A	YELLOW
HFS/HR1C	08	HY	-	P0845	A	A	BLUE
HFS	12	HY	-	P1130	A	A	GREEN
HFS	16	HY	-	P1395	A	A	BLACK
HFS2/HR2C	04	HY	-	P0625	A	A	PURPLE
HFS2/HR2C	06	HY	-	P0740	A	A	YELLOW
HFS2/HR2C	08	HY	-	P0870	A	A	BLUE
HFS2/HR2C	10	HY	-	P1015	A	A	ORANGE
HFS2/HR2C	16	HY	-	P1450	A	A	BLACK
HLB	2	CY	-	P0368	A	A	BROWN
HLB	3	CY	-	P0505	A	A	GRAY
R6	06	HY	-	P0740	A	A	YELLOW
R6	08	HY	-	P0870	A	A	BLUE
R6	10	HY	-	P1100	A	A	ORANGE
R6	12	HY	-	P1245	A	A	GREEN

* See "Crimp Specification and Tool Selection Chart" in this catalog for the proper die ring for these hose sizes. All other hoses use the SILVER RING only.
 † Crimp Machine Code: A = All models; B = Parkrimp II and Superkrimp only.



Hydraulic & Pneumatic Hose & Fit.
 PTFE Hose & Fittings
 Thermoplastic Tubing
 Coiled Air Hose, Fittings & Accessories
 Truck (Fleet) Products
 Tooling & Equipment
 Hose Accessories
 Technical & Design Information
 Approvals & Guides
 Alphanumeric Index

Swage and Crimp Die Selection Chart

Hose Type	Size	Fitting Series	Swage Die DIE-	Crimp Die 80C-*83C-	Machine Selection		Color Code
					Brass Steel	Stainless Steel	
R6	16	43	-	M1600	A	A	BLACK
S5	08	55	308	P08	A	A	BLUE
S5	10	43	-	P1130	A	A	GREEN
S6	12	58	H12	P12H	A	A	GREEN
S6	16	58	J16	P16J	A	A	BLACK
S6	12	HY	-	P12H	A	A	GREEN
S6	16	HY	-	P1450	A	A	BLACK
S6	20	SQ	-	T24*	B	B	RED
S9	12	58	H12	P12H	A	A	GREEN
S9	16	58	J16	P16J	A	A	BLACK
S9	12	HY	-	P12H	A	A	GREEN
S9	16	HY	-	P1490	A	A	BLACK
HTB	04	BW	-	P0745	A	A	YELLOW
HTB	06	43	-	A06	A	A	YELLOW
HTB	08	43	-	A08	A	A	BLUE
HTB	10	43	-	A10	A	A	ORANGE
HTB	12	43	-	A12	A	A	GREEN
HTB	16	43	-	A16	A	A	BLACK
M8	06	43	-	M0850	A	A	YELLOW
M8	08	43	-	M1010	A	A	BLUE
M8	10	43	-	M1170	A	A	ORANGE
573X/XL	-3	LV	V03	-	-	-	-
573X	-16	LV	J16	-	-	-	-
919	-3	91	-	T03	A	A	GRAY
919/919U/929/929B	-4	91N	-	T04N	A	A	RED
919/919B	-5	91N	-	T05N	A	A	PURPLE
919/919B/919U/929/929B	-6	91N	-	T06N	A	A	YELLOW
919/919B/919U/929/929B	-8	91N	-	T08N	A	A	BLUE
919	-10	91N	-	T10N	A	A	ORANGE
919/919U/929B	-12	91N	-	T12N	A	A	GREEN
919/919U	-16	91N	-	T16N	A	A	BLACK
919	-20	91	-	T20	A	A	WHITE
919J/929BJ	-4	91N	-	T04J	A	A	RED
919J/929BJ	-5	91N	-	T05J	A	A	PURPLE
919J/929BJ	-6	91N	-	T06J	A	A	YELLOW
919J/929BJ	-8	91N	-	T08J	A	A	BLUE
919J/929BJ	-10	91N	-	T10J	A	A	ORANGE
919J/929BJ	-12	91N	-	T12J	A	A	GREEN
919J	-16	91N	-	T16	A	A	BLACK
929B	-16	91N	-	T16H	A	A	BLACK
929BJ	-16	91N	-	T16HJ	A	A	BLACK
939/939B	-10	93N	-	83C-T10*	A	A	ORANGE
939/939B	-12	93N	-	83C-T12*	A	A	GREEN
939/939B	-16	93N	-	83C-T16*	B	B	BLACK
939/939B	-20	93N	-	83C-T20*	B	B	WHITE
939/939B	-24	93N	-	83C-T24*	B	B	RED
939/939B	-32	93N	-	83C-T32*	B	B	GREEN

* Use silver spacer ring only with all Parflex hoses. Do not use black spacer ring on the SuperKrimp, ParKrimp I or ParKrimp II. Parflex Crimp Dies can be further identified by machined grooves in the top of dies: 55 Series has one groove - 58 Series has two grooves - 91N Series has three grooves.
 † Crimp Machine Code: A = All models; B = ParKrimp II and Superkrimp only.



Hydraulic & Pneumatic Hose & Fit.

PTFE Hose & Fittings

Thermoplastic Tubing

Coiled Air Hose, Fittings & Accessories

Truck (Fleet) Products

Tooling & Equipment

Hose Accessories

Technical & Design Information

Approvals & Guides

Alphanumeric Index

Recommended Practices for Hydraulic Hose Assemblies

Foreword — This SAE Recommended Practice is intended as a guide to consider when selecting, routing, fabricating, installing, replacing, maintaining and storing hose for fluid-power systems. It is subject to change to keep pace with experience and technical advances. For those new to hose use in fluid-power systems, this guide outlines practices to note during each phase of system design and use. Experienced designers and users skilled in achieving proper results, as well as the less experienced, can use this outline as a list of considerations to keep in mind.

Fluid power systems are complex and require extensive knowledge of both the system requirements and the various types of hose. Therefore, all-inclusive, detailed, step-by-step instructions are not practical and are beyond the scope of this document. Less experienced designers and user's who need more information can consult specialists such as hose suppliers and manufacturers. This guide can improve the communication process.

Safety Considerations — These recommended practices involve safety considerations; note these carefully during all phases of design and use of hose systems. Improper selection, fabrication, installation or maintenance of hose and hose assemblies for fluid-power systems may result in serious personal injury or property damage. These recommended practices can reduce the likelihood of component or system failure, thereby reducing the risk of injury or damage.

1. Scope – SAE J1273 provides guidelines for selection, routing, fabrication, installation, replacement, maintenance and storage of hose and hose assemblies for fluid-power systems. Many of these SAE Recommended Practices also may be suitable for other hose and systems.

2. References

2.1 Applicable Documents – The following publications form a part of this specification to the extent specified herein. Unless otherwise specified, the latest issue of SAE publications shall apply.
SAE J343 – Test and Procedures for SAE 100 R Series Hydraulic Hose and Hose Assemblies.
SAE J514 – Hydraulic Tube Fittings
SAE J517 – Hydraulic Hose
SAE J1927 – Cumulative Damage Analysis for Hydraulic Hose Assemblies

2.1.2 ISO Publication – Available from ANSI, 11 West 42nd Street, New York, NY 10036-8002.
ISO 3457 – Earth Moving Machinery—Guards and Shields—Definitions and Specifications

3. Explanation of Terms – These explanations serve only to clarify this document and are not intended to stand alone. They are presented sequentially, with the former helping to explain the latter.

3.1 Fluid Power – Energy transmitted and controlled using pressurized hydraulic fluids or compressed air.

3.2 Hose – Flexible conductor. In this document, the term hose may also refer to a hose assembly with related accessories used in fluid power applications.

3.3 Hose Fitting or Fitting – Connector which can be attached to the end of a hose.

3.4 Hose Assembly – Hose with hose fittings attached.

3.5 Hose Failure – Occurrence in which a hose stops meeting system requirements.

3.6 Hose Service Life – Length of time a hose meets system requirements without needing replacement.

4. Safety Considerations – Listed in 4.1 to 4.7 are some

potential conditions and situations that may lead to personal injury and/or property damage. The list is not necessarily all inclusive. Consider reasonable and feasible means, including those described in this section, to reduce the risk of injuries or property damage.

4.1 Fluid Injections – Fine streams of escaping pressurized fluid can penetrate skin and enter a human body. These fluid injections may cause severe tissue damage and loss of limb. Consider various means to reduce the risk of fluid injections, particularly in areas normally occupied by operators. Consider careful routing, adjacent components, warnings, guards, shields and training programs. Relieve pressure before disconnecting hydraulic or other lines. Tighten all connections before applying pressure. Avoid contact with escaping fluids. Treat all leaks as though pressurized and hot enough to burn skin. Never use any part of your body to check for hose leaks. If a fluid-injection accident occurs, see a doctor immediately. **DO NOT DELAY OR TREAT AS A SIMPLE CUT!** Any fluid injected into the skin must be surgically removed within a few hours or gangrene may result. Doctors unfamiliar with this type of injury should consult a knowledgeable medical source.

4.2 Whipping Hose – If a pressurized hose assembly blows apart, the fittings can be thrown off at high speed, and the loose hose can flail or whip with great force. This is especially true in compressible-fluid systems. When this risk exists, consider guards and restraints to protect against injury.

4.3 Burns from Conveyed Fluids – Fluid-power media may reach temperatures that can burn human skin. If there is risk of burns from escaping fluid, consider guards and shields to prevent injury, particularly in areas normally occupied by operators.

4.4 Fire and Explosion from Conveyed Fluids – Most fluid-power media, including fire-resistant hydraulic fluids, will burn under certain conditions. Fluids which escape from pressurized systems may form a mist or fine spray which can flash or explode upon contact with an ignition source. Consider selecting, guarding, and routing hose to minimize the risk of combustion. (See Section 5 and ISO 3457).

4.5 Fire and Explosions from Static-Electric Discharge – Fluid passing through hose can generate static electricity, resulting in static-electric discharge. This may create sparks that can ignite system fluids or gases in the surrounding atmosphere. When this potential exists, select hose specifically designed to carry the static-electric charge to ground.

Hydraulic & Pneumatic Hose & Fit.

PTFE Hose & Fittings

Thermoplastic Tubing

Coiled Air Hose, Fittings & Accessories

Truck (Fleet) Products

Tooling & Equipment

Hose Accessories

Technical & Design Information

Approvals & Guides

Alphanumeric Index

4.6 Electrical Shock – Electrocutation could occur if hose conducts electricity through a person. Most hoses are conductive. Many contain metal or have metal fittings. Even nonconductive hoses can be conduits for electricity if they carry conductive fluids. Be aware of routing or using hose near electrical sources. When this cannot be avoided, select appropriate hose. Nonconductive hoses should be considered. SAE J517–100R7 and 100R8 hoses, with orange covers marked “Nonconductive” are available for applications requiring nonconductive hose.

4.7 Mechanisms Controlled by Fluid Power – Mechanisms controlled by fluid in hoses can become hazardous when a hose fails. For example, when a hose bursts, objects supported by fluid pressure may fall, or vehicles or machines may lose their brakes or steering. If mechanisms are controlled by fluid power, consider safe modes of failure that minimize risks of injury or damage.

5. Hose Selection and Routing – A wide variety of interacting factors influence hose service life and the ability of each fluid-power system to operate satisfactorily, and the combined effects of these factors on service life are often unpredictable. Therefore, these documents should not be construed as design standards. For applications outside the specifications in SAE J517, SAE J514, or other relevant design standards, performance of hose assemblies should be determined by appropriate testing. Carefully analyze each system. Then design routings and select hose and related components to meet the system-performance and hose-service-life requirements, and to minimize the risks of personal injury and/or property damage. Consider the following factors:

5.1 System Pressures – Excessive pressure can accelerate hose assembly failure. Analyze the steady-state pressures, and the frequency and the amplitude of pressure surges, such as pulses and spikes. These are rapid and transient rises in pressure which may not be indicated on many common pressure gauges and can be identified best on high-frequency-response electronic measuring instruments. For maximum hose service life, hose selection should be based on a system pressure, including surges, that is less than the hose maximum working pressure. Hose may be used above its maximum working pressure where reduced life expectancy is acceptable. SAE J1927 provides on method to help predict wire-reinforced hose service for a given hydraulic application, where the surge pressure peaks vary, and/or the highest pressure peaks occur infrequently.

5.2 Suction – For suction applications, such as inlet flow to pumps, select hose to withstand both the negative and positive pressures the system imposes on the hose.

5.3 External Pressure – In certain applications, such as in autoclaves or under water, the external environmental pressures may exceed the fluid pressure inside the hose. In these applications, consider the external pressures, and, if necessary, consult the manufacturers.

5.4 Temperature – Exceeding hose temperature ratings may significantly reduce hose life. Select hose so the fluid and ambient temperatures, both static and transient, fall within the hose ratings. The effects of external heat sources should not raise the temperature of the hose above its maximum operating temperature. Select hose, heat shields, sleeving, and other methods for these requirements, and route or shield hose to avoid hose damage from external heat sources.

5.5 Permeation – Permeation, or effusion, is seepage of fluid

more permeable than others. Consider the effects of permeation when selecting hose, especially with gaseous fluids. Consult the hose and fluid manufacturers for permeability information.

5.6 Hose-Material Compatibility – Variables that can affect compatibility of system fluids with hose materials include, but are not limited to:

- A. Fluid Pressure
- B. Temperature
- C. Concentration
- D. Duration of exposure

Because of permeation (see 5.5), consider compatibility of system fluids with the hose, tube, cover, reinforcement, and fittings. Consult the fluid and hose manufacturers for compatibility information. **NOTE**—Many fluid/elastomer compatibility tables in manufacturers’ catalogs show ratings based on fluids at 21° C, room temperature. These ratings may change at other temperatures. Carefully read the notes on the compatibility tables, and if in doubt, consult the manufacturer. **NOTE—See pages 282-289 for chemical resistance information.**

5.7 Environment – Environmental conditions can cause hose and fitting degradation. Conditions to evaluate include, but are not limited to:

- A. Ultraviolet light
- B. Salt water
- C. Air pollutants
- D. Temperature
- E. Ozone
- F. Chemicals
- G. Electricity
- H. Abrasion

If necessary, consult the manufacturers for more information.

5.8 Static-Electric Discharge – Fluid passing through hose can generate static electricity resulting in static-electric discharge. This may create sparks that can puncture hose. If this potential exists, select hose with sufficient conductivity to carry the static-electric charge to the ground.

5.9 Sizing – The power transmitted by pressurized fluid varies with pressure and rate of flow. Select hose with adequate size to minimize pressure loss, and to avoid hose damage from heat generation or excessive velocity. Conduct calculations, or consult the manufacturers for sizing at flow velocities.

5.10 Unintended Uses – Hose assemblies are designed for the internal forces of conducted fluids. Do not pull hose or use it for purposes that may apply external forces for which the hose or fittings were not designed.

5.11 Specifications and Standards – When selecting hose and fittings for specific applications, refer to applicable government, industry, and manufacturer’s specifications and standards.

5.12 Unusual Applications – Applications not addressed by the manufacturer or by industry standards may require special testing prior to selecting hose.

5.13 Hose Cleanliness – The cleanliness requirements of system components, other than hose, will determine the cleanliness requirements of the application. Consult the component manufacturers’ cleanliness information for all components in the system. Hose assemblies vary in cleanliness levels; therefore, specify hose assemblies with adequate cleanliness for the system.



5.14 Hose Fittings – Selection of the proper hose fittings for the hose and application is essential for proper operation and safe use of hose and related assembly equipment. Hose fittings are qualified with the hose. Therefore, select only hose fittings compatible with the hose for the applications.

Improper selection of hose fittings or related assembly equipment for the application can result in injury or damage from leaks, or from hose assemblies blowing apart (see 4.2, 6.2, 6.3 and 6.4).

5.15 Vibration – Vibration can reduce hose service life. If required, conduct tests to evaluate the frequency and amplitude of system vibration. Clamps or other means may be used to reduce the effects of vibration. Consider the vibration requirements when selecting hose and predicting service life.

5.16 Hose Cover Protection – Protect the hose cover from abrasion, erosion, snagging and cutting. Special abrasion-resistant hoses and hose guards are available for additional protection. Route hose to reduce abrasion from hose rubbing other hose or objects that may abrade it.

5.17 External Physical Abuse – Route hose to avoid:

- A. Tensile loads
- B. Side loads
- C. Flattening
- D. Thread damage
- E. Kinking
- F. Damage to sealing surfaces
- G. Abrasion
- H. Twisting

5.18 Swivel-Type Adapters – Swivel-type fittings or adapters do not transfer torque to hose while being tightened. Use these as needed to prevent twisting during installation.

5.19 Live Swivels – If two components in the system are rotating in relation to each other, live swivels may be necessary. These connectors reduce the torque transmitted to the hose.

5.20 Slings and Clamps – Use slings and clamps to support heavy or long hose and to keep it away from moving parts. Use clamps that prevent hose movement that will cause abrasion.

5.21 Minimum Bend Radius – The minimum bend radius is defined in SAE J343 and is specified in other SAE standards and hose manufacturer’s product literature. Routing at less than minimum bend radius may reduce hose life. Sharp bending at the hose/fitting juncture may result in leaking, hose rupturing, or the hose assembly blowing apart (see 4.2 and Figure 1).

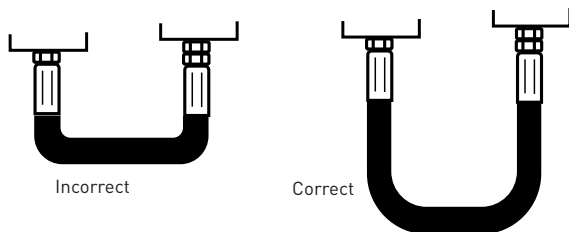

FIGURE 1 — MINIMUM BEND RADIUS

5.22 Elbows and Adapters – In special cases, use elbows and adapters to relieve hose strain (see Figure 2).

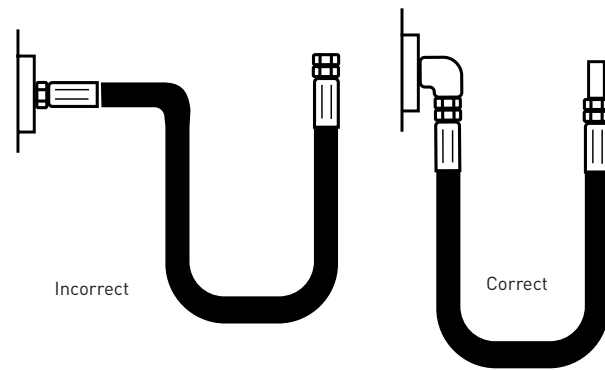

FIGURE 2 — ELBOWS AND ADAPTERS

5.23 Lengths – Unnecessarily long hose can increase pressure drop and affect system performance. When pressurized, hose that is too short may pull loose from its fittings, or stress the fitting connections, causing premature metallic or seal failures. When establishing hose length, refer to Figures 3, 4, and 5; and use the following practices:

5.23.1 Motion Absorption – Provide adequate hose length to distribute movement and prevent bends smaller than the minimum bend radius.

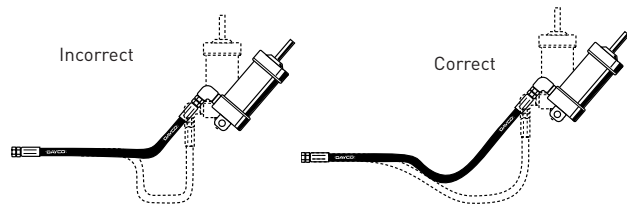

FIGURE 3 — MOTION ABSORPTION

5.23.2 Hose and Machine Tolerances – Design hose to allow for changes in length due to machine motion and tolerances.

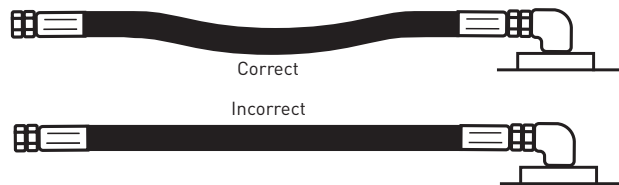

FIGURE 4 — HOSE AND MACHINE TOLERANCES

5.23.3 Hose Length Due To Pressure – Design hose to accommodate length changes from changing pressures. Do not cross or clamp together high- and low-pressure hoses. The difference in length changes could wear the hose covers.

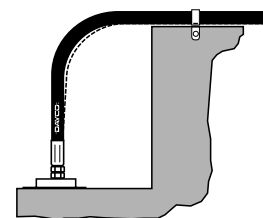

FIGURE 5 — HOSE LENGTH DUE TO PRESSURE

Hydraulic & Pneumatic Hose & Fit.

PTFE Hose & Fittings

Thermoplastic Tubing

Coiled Air Hose, Fittings & Accessories

Truck (Fleet) Products

Tooling & Equipment

Hose Accessories

Technical & Design Information

Approvals & Guides

Alphanumeric Index

5.24 Hose Movement and Bending – Hose allows relative motion between system components. Analyze this motion when designing hose systems. The number of cycles per day may significantly affect hose life. Also avoid multiple planes of motion and twisting motion. Consider the motion of the hose when selecting hose and predicting service life. In applications that require hose to move or bend, refer to Figures 6 and 7; and use these practices:

5.24.1 Bend in Only One Plane to Avoid Twisting

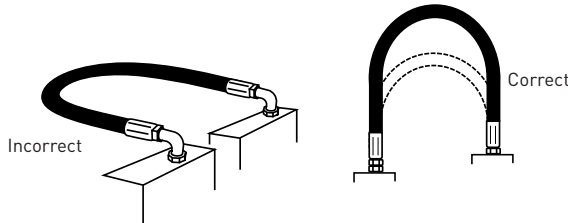

FIGURE 6 — BEND IN ONLY ONE PLANE TO AVOID TWISTING

5.24.2 Prevent Hose Bending in More Than One Plane – If hose follows a compound bend, couple it into separate segments, or clamp into segments that flex in only one plane.

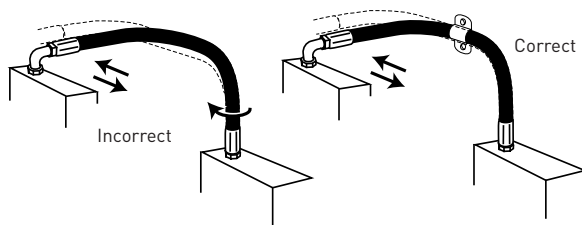

FIGURE 7 — PREVENT HOSE BENDING IN MORE THAN ONE PLANE

6. Hose-Assembly Fabrication – Persons fabricating hose assemblies should be trained in the proper use of equipment and materials. The manufacturers’ instructions and the practices listed as follows must be followed. Properly assembled fittings are vital to the integrity of a hose assembly. Improperly assembled fittings can separate from the hose and may cause serious injury or property damage from whipping hose, or from fire or explosion of vapor expelled from the hose.

6.1 Component Inspection – Prior to assembly, examine components for:

- A. Style or type
- B. Cleanliness
- C. Loose covers
- D. Nicks
- E. Size
- F. Inside obstructions
- G. Visible defects
- H. Damage
- I. Length
- J. Blisters
- K. Burrs

6.2 Hose Fittings – Hose fitting components from one manufacturer are not usually compatible with fittings components supplied by another manufacturer. For example, do not use a hose fitting nipple from one manufacturer with a

hose socket from another manufacturer. It is the responsibility of the fabricator to consult the manufacturer’s written instructions or the manufacturer directly for information on proper fitting components.

6.3 Hose and Fitting Compatibility – Care must be taken to determine proper compatibility between the hose and fitting. Base selection on the manufacturers’ recommendations substantiated by testing to industry standards such as SAE J517. Hose from one manufacturer is not usually compatible with fittings from another. Do not intermix hose and fittings from two manufacturers without approval from both manufacturers.

6.4 Hose Assembly Equipment – Assembly equipment from one manufacturer is usually not interchangeable with that from another manufacturer. Hoses and fittings from one manufacturer should not generally be assembled with the equipment of another manufacturer.

6.5 Safety Equipment – During fabrication, use proper safety equipment, including eye protection, breathing apparatus, and adequate ventilation.

6.6 Reuse of Hose and Fittings – When fabricating hose assemblies, do not reuse:

- A. Field-attachable fittings that have blown or pulled off hose.
- B. Any part of hose fittings that were permanently crimped or swaged to hose.
- C. Hose that has been in service after system check out (see 7.7).

6.7 Cleanliness of Hose Assemblies – Hose assemblies may be contaminated during fabrication. Clean hoses to specified cleanliness levels (see 5.13).

7. Hose Installation and Replacement – Use the following practices when installing hose assemblies in new systems or replacing hose assemblies in existing systems:

7.1 Pre-Installation Inspection – Before installing hose assemblies, examine:

- A. Hose length and routing for compliance with original design.
- B. Assemblies for correct style, size, length and visible nonconformities.
- C. Fitting sealing surfaces for burrs, nicks, or other damage.

NOTE: When replacing hose assemblies in existing systems, verify that the replacement is of equal quality to the original assembly.

7.2 Handling During Installation – Handle hose with care during installation. Kinking hose, or bending at less than minimum bend radius may reduce hose life. Avoid sharp bending at the hose/fitting juncture (see 5.21).

7.3 Twist Angle and Orientation – Pressure applied to a twisted hose may shorten the life of the hose or loosen the connections. To avoid twisting, use the hose lay line or marking as a reference (see Figure 8).

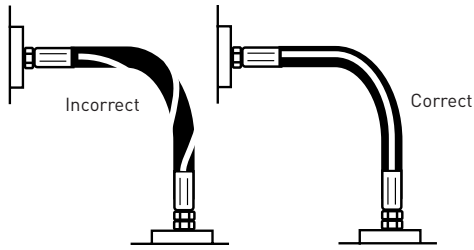

FIGURE 8 — TWIST ANGLE AND ORIENTATION

7.4 Securement and Protection – Install necessary restraints and protective devices. Determine that such devices do not create additional stress or wear points.

7.5 Routing – Review proper routing practices provided in Section 5 and make appropriate corrections to obtain optimum performance.

7.6 Assembly Torque – The connection end of a hose is normally threaded to obtain a tight pressure seal when attached to a port, an adapter, or another fitting. Sometimes bolts or screws provide the threaded connection. Each size and type of connection requires different torque values, and these may vary due to type of material or exterior coating.

7.7 System Checkouts – In hydraulic or other liquid systems, eliminate all air entrapment after completing the installation. Follow manufacturers’ instructions to test the system for possible malfunctions and leaks.

7.7.1 To avoid injury during system checkouts:

- A. Do not touch any part of the system when checking for leaks (see 4.1).
- B. Stay out of potentially hazardous areas while testing hose systems (see Section 4).
- C. Relieve system pressure before tightening connections.

8. Maintenance Inspection – A hose and fitting maintenance program may reduce equipment downtime, maintain peak operating performance, and reduce the risk of personal injury and/or property damage. The user should design and implement a maintenance program that suits the specific application and each specific hose in that application.

8.1 Inspection Frequency – Evaluate factors such as the nature and severity of the application, past history, and manufacturers’ information to establish the frequency of visual inspections and functional tests.

8.2 Visual Inspection (Hose and Fittings) – Visually inspect hose and fittings for:

- A. Leaks at hose fitting or in hose.
- B. Damaged, cut or abraded cover.
- C. Exposed reinforcement.
- D. Kinked, crushed, flattened, or twisted hose.
- E. Hard, stiff, heat cracked, or charred hose.
- F. Blistered, soft, degraded, or loose cover.
- G. Cracked, damaged, or badly corroded fittings.
- H. Fitting slippage on hose.
- I. Other signs of significant deterioration. If any of these conditions exist, evaluate the hose assemblies for correction or replacement.

8.3 Visual Inspection (All Other Components) – When visually

inspecting hose and fittings, inspect for related items including:

- A. Leaking ports.
- B. Damaged or missing hose clamps, guards or shields.
- C. Excessive dirt and debris around hose.
- D. System fluid: Level, type, contamination, condition and air entrainment. If any of these are found, address them appropriately.

8.4 Functional Test – Functional tests determine if systems are leak free and operating properly. Carry out functional tests per information from equipment manufacturers.

9. Hose Storage – Age control and the manner of storage can affect hose life. Use the following practices when storing hose.

9.1 Age Control – Maintain a system of age control to determine that hose is used before its shelf life has expired. Shelf life is the period of time when it is reasonable to expect the hose to retain full capabilities for rendering the intended service.

Store hose in a manner that facilitates age control and first-in, first-out usage based on manufacturing date on hose or hose assembly. Per SAE J517:

- A. Shelf life of rubber hose in bulk form, or in hose assemblies passing visual inspection and proof test, is forty quarters (ten years) from the date of vulcanization.
- B. Shelf life of thermoplastic and polytetrafluoroethylene hose is considered to be unlimited.

9.2 Storage – Store hose and hose assemblies in a cool, dark, dry area with the ends capped. When storing hose, take care to avoid damage that could reduce hose life, and follow the manufacturers’ information for storage and shelf life. Examples of factors that can adversely affect hose product in storage are:

- A. Temperature
- B. Ozone
- C. Oils
- D. Corrosive liquids and fumes
- E. Rodents
- F. Humidity
- G. Ultraviolet light
- H. Solvents
- I. Insects
- J. Radioactive materials

If there are any questions regarding the quality or usability of hose or hose assemblies, evaluate appropriately:

- A. Flex the hose to the minimum bend radius and compare it with new hose. After flexing, examine the cover and tube for cracks. If any appear, no matter how small, reject the hose.
- B. If the hose is wire reinforced, and the hose is unusually stiff, or a cracking sound is heard during flexing, check for rust by cutting away a section of the cover from a sample. Rust would be another reason for rejection.
- C. If doubt still persists, contact hose assembler to conduct proof-pressure tests or any other tests needed to verify hose quality.

Prepared by the SAE Fluid Conductors and Connectors Technical Committee SC3-Training and Education Subcommittee

Hydraulic & Pneumatic Hose & Fit.

PTFE Hose & Fittings

Thermoplastic Tubing

Coiled Air Hose, Fittings & Accessories

Truck (Fleet) Products

Tooling & Equipment

Hose Accessories

Technical & Design Information

Approvals & Guides

Alphanumeric Index

Selection of Hose Diameter from Flow Rate and Velocity

The Fluid Velocity Nomogram gives the velocity of a liquid or gas as a function of flow rate and inside diameter of the fluid line. The commonly recommended maximum velocities for hydraulic oil systems at 200°F or less are indicated for guidance.

Example: At 10 gpm, what is the minimum size within the recommended velocity range for a hydraulic pressure line?

The dashed line drawn from the 10 gpm mark on the left hand line to the maximum velocity of 20 fps intersects the middle line at .438 " (7/16" I. D. hose or tubing). For a hose application, use 1/2" I. D., the nearest common standard size.

This chart is based on the following formulas: $v_{fps} = \frac{.321Q}{\frac{bd^2}{4}}$, Q = gal per min
d = hose or tube I. D. (inch)

cu. ft./min. = .1337 Q

The cu. ft. per min. value is the actual volume flow rate under flowing conditions. For air, standard cfm of free air = 7.81 actual cfm when the inlet air is at 100 PSig, 68°F.

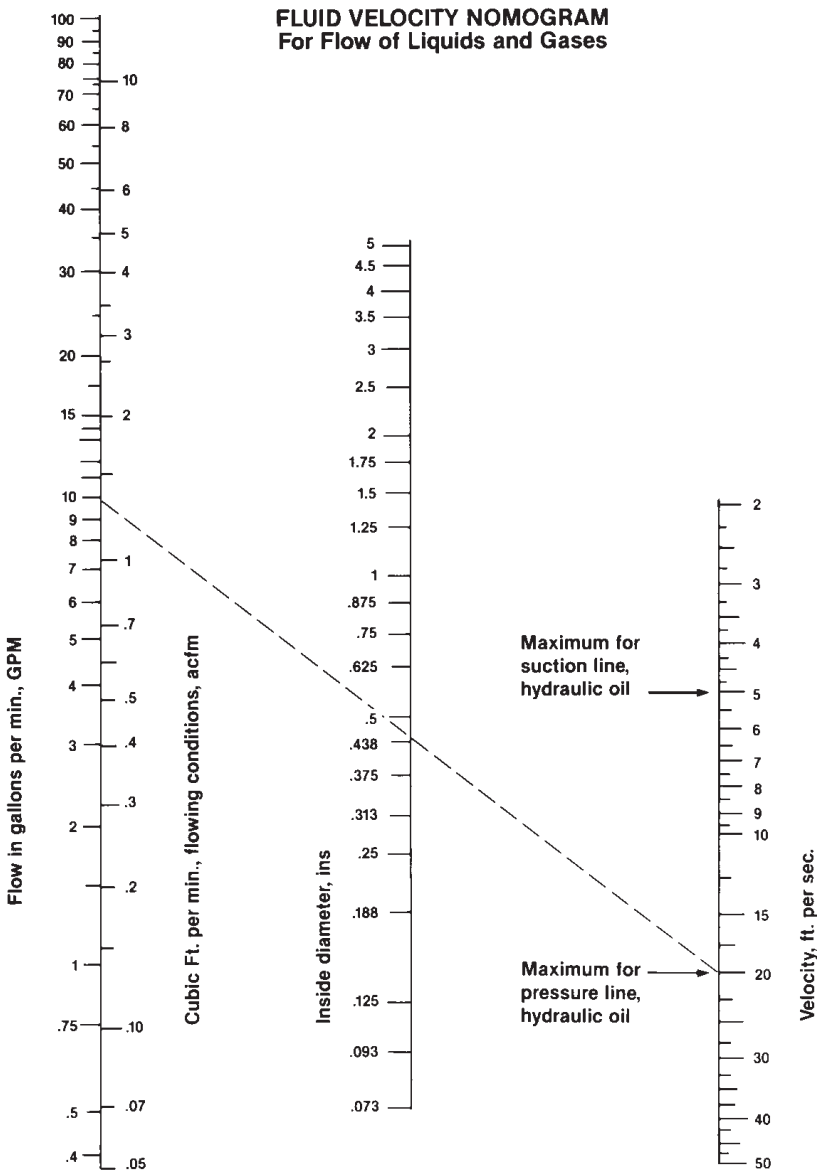

Hydraulic & Pneumatic Hose & Fit.
PTFE Hose & Fittings
Thermoplastic Tubing
Coiled Air Hose, Fittings & Accessories
Truck (Fleet) Products
Tooling & Equipment
Hose Accessories
Technical & Design Information
Approvals & Guides
Alphanumeric Index



Parflex Hose — Calculation of Hose Length for Over-the-Sheave Applications

The exact cutoff length for an optimum over-the-sheave assembly depends on the particular mechanical arrangement of the machine. A method for finding an approximate starting point is as follows:

1. Assemble hose with one coupling as shown in diagram.
2. Measure hose length from point 1 to point 2 **with hose taut (.985 accounts for 1.56 stretch)**. (L_o = length)
3. Calculation of insert allowance (x) may be found from the coupling dimension tabulations in the fittings section or from direct measurement on the coupling. A 1.5% stretch allowance is provided in this formula.
4. Calculate hose cutoff or free length L_F :

$$L_F = 0.985 L_o + 2x$$
 Where L_F includes coupling insert allowance on both ends.
5. Couple the remaining hose end, check crimp, and assemble on the machine.

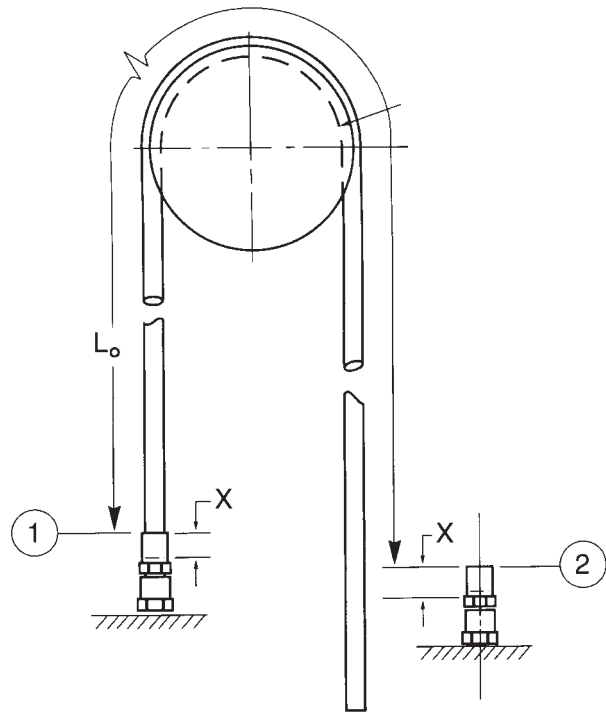

Hydraulic & Pneumatic Hose & Fit.

PTFE Hose & Fittings

Thermoplastic Tubing

Coiled Air Hose, Fittings & Accessories

Truck (Fleet) Products

Tooling & Equipment

Hose Accessories

Technical & Design Information

Approvals & Guides

Alphanumeric Index

Permeation Rate at 120°F
(Pound per Linear Hose Foot per Year)

Hose Size	R12	R22	R507	R404A	R502	R134A
-2	-	.28	-	-	.03	-
-3	-	.30	.08	.07	-	-
-4	-	.71	.15	.10	-	-
-6	-	1.11	-	-	.87	-

Permeation Rate at 212°F
(Pound per Linear Hose Foot per Year)

Hose Size	R12	R22	R507	R404A	R502	R134A
-2	-	-	-	-	-	-
-3	-	1.25	-	-	-	-
-4	.08	2.32	-	-	-	.07
-6	-	-	-	-	-	-

Notes:

1. Data is for comparison only. Actual results may vary due to differences in application temperature and pressure.
2. Data is collected in highly controlled tests per UL1963.
3. Parker Safety Guide for Selecting and Using Hose, Tubing, Fittings and Related Accessories, Section 2.6:

Permeation: Permeation (that is, seepage through the hose) will occur from inside the hose to outside when hose is used with gases, liquid and gas fuels, and refrigerants (including but not limited to such materials as helium, fuel oil, natural gas, or freon). This permeation may result in high concentrations of vapors which are potentially flammable, explosive, or toxic, and in loss of fluid. Dangerous explosions, fires, and other hazards can result when using the wrong hose for such applications. The system designer must take into account the fact that this permeation will take place and must not use hose if this permeation could be hazardous. The system designer must take into account all legal, government, insurance, or any other special regulations which govern the use of fuels and refrigerants. Never use a hose even though the fluid compatibility is acceptable without considering the potential hazardous effects that can result from permeation through the hose assembly.

Permeation of moisture from outside the hose to inside the hose will also occur in hose assemblies, regardless of internal pressure. If this moisture permeation would have detrimental effects (particularly but not limited to refrigeration and air conditioning systems), incorporation of sufficient drying capacity in the system or other appropriate system safeguards should be selected and used.

Hydraulic & Pneumatic Hose & Fit.

PTFE Hose & Fittings

Thermoplastic Tubing

Coiled Air Hose, Fittings & Accessories

Truck (Fleet) Products

Tooling & Equipment

Hose Accessories

Technical & Design Information

Approvals & Guides

Alphanumeric Index

Hydraulic & Pneumatic Hose & Fit.

PTFE Hose & Fittings

Thermoplastic Tubing

Coiled Air Hose, Fittings & Accessories

Truck (Fleet) Products





Tooling & Equipment





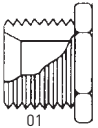
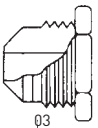
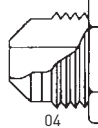

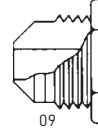
Hose Accessories

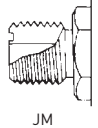
Technical & Design Information

Approvals & Guides

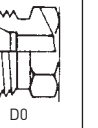
Alphanumeric Index

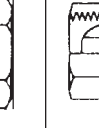
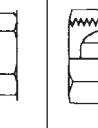
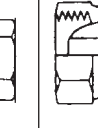
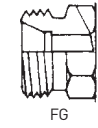
PARFLEX STYLE NO.								
Dash Size	NPTF Pipe Thread Size	SAE (JIC) 37° Flare Thread Size	SAE 45° Flare Thread Size	"O" Ring Style Straight Thread Size	SAE Inverted Flare Thread Size	PTT 30° Flare Thread Size	SAE Flareless Thread Size	Seal-Lok Thread
2	1/8 - 27	5/16 - 24	5/16 - 24	5/16 - 24	-	-	5/16 - 24	-
3	-	3/8 - 24	3/8 - 24	3/8 - 24	-	-	3/8 - 24	-
4	1/4 - 18	7/16 - 20	7/16 - 20	7/16 - 20	1/4 - 18	-	7/16 - 20	9/16 - 18
5	-	1/2 - 20	1/2 - 20	1/2 - 20	-	-	1/2 - 20	-
6	3/8 - 18	9/16 - 18	5/8 - 18	9/16 - 18	3/8 - 18	-	9/16 - 18	11/16 - 16
8	1/2 - 14	3/4 - 16	2 3/4 - 16	2 3/4 - 16	1/2 - 14	-	3/4 - 16	13/16 - 16
10	-	7/8 - 14	7/8 - 14	7/8 - 14	-	-	7/8 - 14	1 - 14
12	3/4 - 14	1 1/16 - 12	1 1/16 - 12	1 1/16 - 12	-	-	1 1/16 - 12	13/16 - 12
14	-	1 3/16 - 12	-	1 3/16 - 12	-	-	1 3/16 - 12	-
16	1 - 11 1/2	1 5/16 - 12	-	1 5/16 - 12	-	1 5/16 - 14	1 5/16 - 12	1 7/16 - 12
20	1 1/4 - 11 1/2	1 5/8 - 12	-	1 5/8 - 12	-	1 5/8 - 14	1 5/8 - 12	-
24	1 1/2 - 11 1/2	1 7/8 - 12	-	1 7/8 - 12	-	1 7/8 - 14	1 7/8 - 12	-
32	2 - 11 1/2	2 1/2 - 12	-	2 1/2 - 12	-	2 1/2 - 12	2 1/2 - 12	-

PARFLEX STYLE NO.									
Fitting Size	Metric Swivel Female Thread Size	Metric Swivel Female Thread Size	Male Stud Thread Size	Male Stud Thread Size	Male BSPP Thread Size	BSP Swivel Female Thread Size	French Swivel Female Gas Series	French Swivel Female Metric Series	French Male Stud Gas Series
4	-	-	-	-	1/4"	1/4"	-	-	-
6	M12 x 1,5	-	M12 x 1,5	-	3/8"	3/8"	-	M12 x 1	-
8	M14 x 1,5	M16 x 1,5	M14 x 1,5	M16 x 1,5	1/2"	1/2"	-	M14 x 1,5	-
10	M16 x 1,5	M18 x 1,5	M16 x 1,5	M18 x 1,5	-	5/8"	-	M16 x 1,5	-
12	M18 x 1,5	M20 x 1,5	M18 x 1,5	M20 x 1,5	3/4"	3/4"	-	M18 x 1,5	-
-	-	-	-	-	-	-	M20 x 1,5	-	M20 x 1,5
14	-	M22 x 1,5	-	M22 x 1,5	-	-	-	M20 x 1,5	-
15	M22 x 1,5	-	M22 x 1,5	-	-	-	-	M22 x 1,5	-
16	-	M24 x 1,5	-	M24 x 1,5	1"	1"	-	M24 x 1,5	-
-	-	-	-	-	-	-	M24 x 1,5	-	M24 x 1,5
18	M26 x 1,5	-	M26 x 1,5	-	-	-	-	M27 x 1,5	-
20	-	M30 x 2	-	M30 x 2	-	-	-	M27 x 1,5	-
-	-	-	-	-	-	-	M30 x 1,5	-	M30 x 1,5
22	M30 x 2	-	M30 x 2	-	-	-	-	M30 x 1,5	-
25	-	M36 x 2	-	M36 x 2	-	-	-	M33 x 1,5	-
-	-	-	-	-	-	-	M36 x 1,5	-	M36 x 1,5
28	M36 x 2	-	M36 x 2	-	-	-	-	-	-
30	-	M42 x 2	-	M42 x 2	-	-	-	M39 x 1,5	-
33	-	-	-	-	-	-	M45 x 1,5	-	M45 x 1,5



Hydraulic & Pneumatic Hose & Fit.

PTFE Hose & Fittings

Thermoplastic Tubing

Coiled Air Hose, Fittings & Accessories

Truck (Fleet) Products

Tooling & Equipment

Hose Accessories

Technical & Design Information

Approvals & Guides

Alphanumeric Index

Media	Fitting Material			Seal Material			
	Brass	Steel	316 SS	BUNA-N	Ethylene Propylene	Fluorocarbon	Neoprene
Acetylene	NR	F	S	S	S	S	F
Air (oil free) @ 190° F	S	F	S	S	S	S	S
Air (oil free) @ 300° F	S	F	S	F	F	S	F
Air (oil free) @ 400° F	S	F	S	NR	NR	S	NR
Alcohol, Ethyl	S	NR	NR	NR	S	NR	S
Animal Oils (Lard Oil)	F	F	F	S	F	S	F
Aromatic Fuel - 50%	ID	ID	ID	F	NR	S	NR
Aromatic Solvents	ID	F	F	ID	S	NR	
Asphalt	NR	NR	S	F	NR	S	F
ASTM Oil #1	S	S	S	S	NR	S	S
ASTM Oil #2	S	S	S	S	NR	S	F
ASTM Oil #3	S	S	S	S	NR	S	NR
ASTM Oil #4	S	S	S	F	NR	S	NR
ATF Oil	S	S	S	S	NR	S	F
Automotive Brake Fluid	ID	ID	ID	NR	S	NR	F
Benzene	NR	F	NR	NR	NR	S	NR
Brine (Sodium Chloride)	NR	NR	S	S	S	S	S
Butane	NR	S	S	S	NR	S	S
Carbon Dioxide	S	F	S	S	S	S	S
Carbon Monoxide	S	S	S	S	S	S	F
Chlorine (Dry)	F	F	NR	NR	ID	F	F
Compressed Air	S	F	S	S	S	S	S
Crude Oil	NR	F	S	F	NR	S	NR
Cutting Oil	ID	S	S	S	NR	S	F
Diesel Fuel	S	S	S	S	NR	S	NR
Ethanol	S	NR	NR	NR	S	NR	S
Ethers	S	S	S	NR	F	F	NR
Freon 11	S	ID	ID	F	NR	F	NR
Freon 12	S	S	NR	F	NR	S	S
Freon 22	S	NR	S	NR	NR	NR	S
Fuel Oil	NR	S	S	S	NR	S	F
Gasoline	S	F	S	S	NR	S	NR
Gas, Liquid Propane (LPG)	S	S	S	S	NR	S	F
Gas, Natural	F	S	S	S	NR	S	S
Helium	S	S	S	S	S	S	S
Hydraulic Oil, Petroleum Base	S	S	S	S	NR	S	S
Hydraulic Oil, Water Base	ID	S	S	F	S	NR	F
Hydrogen Gas	S	S	S	S	S	S	S
Jet Fuel	S	S	S	S	NR	S	NR
Kerosene	S	S	S	S	NR	S	F
Lubricating Oil SAE 10, 20, 30, 40, 50	S	S	S	S	NR	S	F
Methanol	S	S	S	S	S	NR	S
MIL-F-8192 (JP-9)S	S	S	NR	NR	S	NR	
MIL-H-5606	S	S	S	S	NR	S	F
MIL-H-6083	S	S	S	S	NR	S	S
MIL-H-7083	S	S	S	S	S	F	F
MIL-H-8446 (MLO-8515)	F	S	S	F	NR	S	S
Mil-L-2104 & 2104B	S	S	S	S	NR	S	F
MIL-L-7808	NR	F	S	F	NR	S	NR
Mineral Oil	S	S	S	S	NR	S	F
Nitrogen	S	S	S	S	S	S	S
Petrolatum	S	S	S	S	NR	S	F
Petroleum Oil (←250° F)	S	S	S	S	NR	S	F
Propane	S	S	S	S	NR	S	F
R134A	S	S	S	NR	S	NR	NR
Sea Water	F	NR	S	S	S	S	F
Skydrol 500, Type 2	NR	S	S	NR	S	NR	NR
Skydrol 7000, Type 2	NR	S	S	NR	S	F	NR
Soap Solutions	NR	NR	S	S	S	S	F
Steam (←400° F)	F	S	S	NR	S	NR	NR
Stoddard Solvent	F	S	S	S	NR	S	F
Transmission Fluid (Type A)	S	S	S	S	NR	S	F
Trichloroethane	ID	F	S	NR	NR	S	NR
Water	S	F	S	S	S	F	F

Table U4 — Fluid Compatibility Chart

Codes:
 S = Satisfactory
 NR = Not recommended
 F = Fair
 ID = Insufficient data



Metal Tube and Fitting Material Compatibility

As a general rule, tube and fitting materials should be the same. If different materials must be considered, the following chart can be used as a general guide. Since operating conditions differ with applications, this chart should be used only as a guide and not a firm recommendation. Before making a final decision on material combination, it should be sufficiently tested under appropriate conditions to assure suitability for the intended application. For additional material combinations, contact the Tube Fittings Division.

Tube Material	Specification	Construction	Condition	Max. Hardness	Temperature Range [7]	Application	Tube Material to Fitting & Material Compatibility												
							Seal-Lok ORFS (SAE J1453)			Triple-Lok 37° Flare (SAE J514)				Ferulok Flareless (SAE J514)			Intru-Lok Flareless		E0 / E0-2 Flareless (ISO 8434-1)
							S	SS	B	S	SS	B	M	S	SS	M	B	S, SS, B, M	
Carbon Steel C-1010	SAE J524 (ASTM A179) (8)	Seamless	Fully Annealed	HRB 72	-65° to 500°F -55° to 260°C	High pressure hydraulic, air, & some specialty chem	E	NR	(6)	G	NR	(6)	NR	E	NR	NR	NR	NR	
	SAE J525 (ASTM A178) (8)	Welded & Drawn					E	NR	(6)	E	NR	(6)	NR	E	NR	NR	NR	NR	
	SAE J356	Welded & Flash Controlled					G	NR	(6)	NR	NR	(6)	NR	G	NR	NR	NR	NR	
Carbon Steel C-1021	SAE J2467	Welded & Flash Controlled	Fully Annealed	HRB 75	-65° to 500°F -55° to 260°C	High pressure hydraulic	E	NR	(6)	NR	NR	(6)	NR	E	NR	NR	NR	NR	
	SAE J2435	Welded & Drawn					E	NR	(6)	E	NR	(6)	NR	E	NR	NR	NR	NR	
Carbon Steel High Strength Low Alloy (HSLA)	SAE 2613	Welded & Flash Controlled	Sub-critically annealed	HRB 90	-65° to 500°F -55° to 260°C	High pressure hydraulic	E (10)	NR	(6)	NR	NR	NR	NR	NR	NR	NR	NR	NR	
	SAE J2614	Welded & Drawn					E	NR	(6)	NR	NR	NR	NR	NR	NR	NR	NR	NR	
Alloy Steel 4130	ASTM A519	Seamless			-65° to 500°F -55° to 260°C	High pressure hydraulics	E (4)	NR	NR	NR	NR	NR	NR	NR	NR	NR	NR	NR	
St 37.4 (Carbon Steel)	DIN 2391 Part 2 (Metric)	Seamless	Fully Annealed	HRB 72	-65° to 500°F -55° to 260°C	High pressure hydraulic, air, & some specialty chem	E	NR	NR	G	NR	NR	NR	NR	NR	NR	NR	E	
Stainless Steel 304 & 316	ASTM A213 ASTM A269	Seamless	Fully Annealed	HRB 90	-425° to 1200°F -255° to 650°C (3)	High pressure, high temp, or generally corrosive media (1)	(6)	E	(6)	(6)	G	(6)	NR	(6)	E	NR	NR	NR	
	ASTM A249 ASTM A269	Welded & Drawn					(6)	E	(6)	(6)	E	(6)	NR	(6)	E	NR	NR	NR	
1.4571 1.4541 Stainless Steel	DIN 17458 Tab 8 (Metric)	Seamless	Fully Annealed	HRB 90	-425° to 1200°F -255° to 650°C (3)	High pressure, high temp, or generally corrosive media (1)	(6)	E	NR	(6)	G	NR	NR	NR	E	NR	NR	E	
Copper	SAE J528 (ASTM B-75) (8)	Seamless	Soft Annealed Temper 0	60 Max. Rockwell 15T	-325° to 400°F -200° to 205°C	Low pressure, low temp, water, oil & air	E	(6)	E	G	(6)	E	NR	G (2)	NR	NR	E	E	
Aluminum 6061	ASTM-B210	Seamless	T6 Temper	HRB 56	-325° to 400°F -200° to 205°C	Low pressure, low temp, water, oil, air & some specialty chem	NR	NR	NR	G	NR	NR	NR	E (2)	NR	NR	(6)	NR	
			0 & T4 Temper	HRB 30			E (5)	NR	NR	G	NR	NR	NR	E (2)	NR	NR	(6)	NR	
Monel 400	ASTM-B165	Seamless	Fully Annealed	HRB 70	-400° to 800°F -240° to 425°C	Sour gas, marine & gen chem processing media	NR	(6)	NR	NR	(6)	NR	E	NR	(6)	E	NR	NR	
Nylon		Extruded	Flexible & Semi-Rigid		-60° to 200°F -50° to 95°C	Lube lines, chem process controls & air	NR	NR	NR	NR	NR	NR	NR	G (2)	G (2)	G (2)	E	G (2), (9)	
Polyethylene	ASTM D-1248	Extruded	Instrument Grade		-80° to 150°F -60° to 65°C	Instrumentation lines	NR	NR	NR	NR	NR	NR	NR	G (2)	G (2)	G (2)	E	G (2), (9)	
PVC		Extruded	Instrument & Laboratory Grade		0° to 140°F -20° to 60°C	General purpose laboratory use	NR	NR	NR	NR	NR	NR	NR	NR	NR	NR	G	NR	
PTFE		Extruded & Cintered			-65° to 400°F -55° to 205°C	Very low pressure, high temp, fuel, lube, chem & air	NR	NR	NR	NR	NR	NR	NR	G (2)	G (2)	G (2)	G	G (2), (9)	

Ratings Key:

NR Not Recommended
F Fair

G Good
E Excellent

Fitting Materials Code:

S Steel
SS Stainless Steel

B Brass
M Monel

Table U7— Tube and Fitting Material Compatibility

Notes:

- 1) For highly corrosive media or service environment, contact the Tube Fittings Division.
- 2) Requires different assembly procedure. Contact the Tube Fittings Division.
- 3) Low temperature limit for stainless steel Ferulok fittings is -20°F (-30°C).
- 4) For brazing only. Grade 4130 not recommended with Parflange process.
- 5) For use with Parflange process only. Not recommended with brazing.
- 6) Use depends on specific application. Contact the Tube Fittings Division.
- 7) Applies to tube material.
- 8) Comparable specifications to SAE.
- 9) With metric version of tubing.
- 10) Not tested with Parflange. Contact the Tube Fittings Division.



Hydraulic & Pneumatic Hose & Fit.
PTFE Hose & Fittings
Thermoplastic Tubing
Coiled Air Hose, Fittings & Accessories
Truck (Fleet) Products
Tooling & Equipment
Hose Accessories
Technical & Design Information
Approvals & Guides
Alphanumeric Index

O-Ring Material Selection

Standard O-rings supplied with Parker tube fittings and adapters are 90 durometer hard nitrile (Buna-N) Parker compound #N0552. These O-rings are well suited for most industrial hydraulic and pneumatic systems. They have high extrusion resistance making them suitable for very high pressure static applications. Optional high temperature fluorocarbon, Parker compound #V0894, is also available for higher temperature specifications.

O-rings for other than normal hydraulic media or higher temperature applications can be selected from the following chart. The chart should be used only as a general guide. Before making final selection for a given application, it is recommended that appropriate tests be conducted to assure compatibility with the fluid, temperature, pressure and other environmental conditions.

For fluids not shown in the chart, please contact the Tube Fittings Division.

Polymer	Abbreviated Name	Parker Compound No.	Color	SAE J515 Type	Hardness Shore "A" ⁷⁾	Temperature Range	Recommended For	Not Recommended For
Nitrile-Butadiene	NBR	N0552	Black	CH ²⁾	90 ⁴⁾	-30° to 250° F	Petroleum base oils and fluids, mineral oils, ethylene glycol base fluids, silicone and di-ester base lubricants, air, water under 150°F, and natural gas. Hydrogen fuel cells. Hydrogen fuel cells. Meets FDA requirements for food products. CNG Applications	Phosphate ester base hydraulic fluids, automotive brake fluids, strong acids, ozone, freons, ketones, halogenated hydrocarbons, and methanol.
Nitrile-Butadiene	NBR	N0674	Black	-	70	-30° to 250° F		
Nitrile-Butadiene	NBR	N0103	Black	-	70	-65° to 225° F		
Nitrile-Butadiene (Low compression set)	NBR	N1059	Black	CH ²⁾	90	-30° to 275° F		
Nitrile-Butadiene	NBR	N0507	Black	-	90	-65° to 180° F		
Nitrile-Butadiene	NBR	N0304	Black	-	75	-65° to 225° F		
Nitrile-Butadiene	NBR	N0508	Black	-	75	-35° to 250° F		
Nitrile-Butadiene	NBR	N0756	Black	-	75 ⁴⁾	-65° to 275° F		
Nitrile-Butadiene	NBR	N0756	Black	-	75 ⁴⁾	-65° to 275° F		
Ethylene-Propylene	EPDM	E0540	Black	CA ³⁾	80	-65° to 275° F		
Ethylene-Propylene	EPDM	E0893	Purple ¹⁾	CA ³⁾	80	-65° to 275° F		
Ethylene-Propylene	EPDM	E0962	Black	-	90	-65° to 275° F		
Ethylene-Propylene	EPDM	E0962	Black	-	90	-65° to 275° F		
Neoprene	CR	C0873	Black	-	70	-45° to 250° F	Refrigerants (freons, ammonia), high aniline point petroleum oils, mild acids, and silicate ester lubricants.	Phosphate ester fluids and ketones.
Neoprene	CR	C0944	Red ¹⁾	-	70	-45° to 250° F		
Fluorocarbon	FKM ⁵⁾ or FPM	V0747 V0884 V0894	Black	- - HK ⁴⁾	75 75 90 ⁶⁾	-15° to 400° F -15° to 400° F -15° to 400° F	Petroleum base oils and fluids, some phosphate ester base fluids, silicone and silicate ester base lubricants, di-ester base lubricants, acids and halogenated hydrocarbons.	Ketones, skydrol fluids, amines (VDMH), anhydrous ammonia, low molecular weight esters and ethers, and hot hydrofluoric or chlorosulfonic acids.
Silicone	Si	S0604	Rust ¹⁾	-	70	-65° to 450° F	Dry heat [air to 400°F] and high aniline point oils.	Most petroleum fluids, ketones, water and

Table U6 — O-Ring Selection

- 1) These Parker "Chromassure" color assurance O-rings are available from the Parker Hannifin O-Ring Division. They help eliminate assembly errors, reduce warranty costs and liability risks, and assure safety in aftermarket business.
- 2) Formerly SAE Type I.
- 3) Formerly SAE Type II.
- 4) Formerly SAE Type III.
- 5) "FKM" is the ASTM designation for fluorocarbon. Its ISO designation is "FPM".
- 6) Standard compounds available from stock.
- 7) Use 90 durometer hard O-rings for applications with 1500 PSI or higher pressures.

Corrosion of Base Metals in Contact

The susceptibility of different base metals to corrosion while in contact, depends upon the difference between the contact potentials, or the electromotive voltages of the metals involved. The greater the potential difference is, the greater is the tendency for corrosion. The metal with the higher potential forms the anode and is corroded. The larger the separation distance in the electromotive chart between the two metals in contact, the higher the contact potential and chances for corrosion. For example, zinc and aluminum are very short distance apart in the chart; therefore potential for corrosion when these two metals are in contact is very low. On the other hand, aluminum and passivated 316 stainless steel are far apart; hence, when in contact, the potential for

corrosion is very high. Aluminum, being more anodic metal, will corrode in this combination.

As a general guideline, if the metals are half the length of the chart or more apart, the combination should be avoided. Also, it is not a good idea to combine an anodic metal part with thin cross section, such as thin wall tubing, with a cathodic or less anodic metal part of a heavy cross section, such as a fitting.

Example: A thin wall brass tube with steel fitting is a better, although not ideal, combination than a thin wall steel tube with brass fitting.

Electromotive or Galvanic Series for Metals	
+ Anodic (least noble) corroded 	Magnesium Magnesium alloys Zinc (Parker steel fittings are zinc plated) Berilium Aluminum 5052, 3004, 3003, 1100, 6053 Cadmium Aluminum 2117, 2017, 2024 Mild steel (1018), wrought iron, free machining steel (12L14) Low alloy high strength steel, cast iron Chrome iron (active) 430 Stainless (active) 302, 303, 321, 347, 410, 416, stainless steel (active) Ni-resist 316, 317 stainless steel (active) Carpenter 20Cb-3 stainless (active) Aluminum bronze (CA 687) Hastelloy C (active) Inconel 625 (active) Titanium (active) Lead/Tin solder Lead Tin Inconel 600 (active) Nickel (active) 60 Ni-15 Cr (active) 80 Ni-20 Cr (active) Hastelloy B (active) Naval brass (CA 464), Yellow brass (CA 268), Brass (CA360) Red brass (CA 230), Admiralty brass (CA 443) Copper (CA 102) Maganese bronze (CA 675), Tin bronze (CA 903, 905) 410, 416 Stainless (passive) Phosphor bronze (CA 521, 524) Silicon bronze (CA 651, 655) Nickel silver (CA 732, 735, 745, 752, 754, 757, 764, 770, 794) Cupro Ni 90-10 Cupro Ni 80-20 430 Stainless steel (passive) Cupro Ni 70-30 Nickel aluminum bronze (CA 630, 632) Monel 400, K500 Silver solder Nickel (passive) 60 Ni 15 Cr (passive) Inconel 600 (passive) 80 Ni 20 Cr (passive) Chrome iron (passive) 302, 303, 304, 321, 347 stainless steel (passive) 316, 317 stainless steel (passive) (Parker stainless steel fittings are passivated) Carpenter 20 Cb-3 stainless (passive), Incoloy 825 Silver Titanium (passive), Hastelloy C & C276 (passive), Inconel 625 (passive)
Electric current flows from plus to minus Direction of attack - Cathodic (most noble) protected 	Graphic Zirconium Gold Platinum

Table U5 — Electromotive or Galvanic Series for Metals

- Hydraulic & Pneumatic Hose & Fit.
- PTFE Hose & Fittings
- Thermoplastic Tubing
- Coiled Air Hose, Fittings & Accessories
- Truck (Fleet) Products
- Tooling & Equipment
- Hose Accessories
- Technical & Design Information
- Approvals & Guides
- Alphanumeric Index

Ratings Code:

- G - Good to excellent. Little or no swelling, tensile or surface changes. Preferred choice.
- L - Marginal or conditional. Noticeable effects but not necessarily indicating lack of serviceability. Further testing suggested for specific application. Very long-term effects such as stiffening or potential for crazing should be evaluated.
- P - Poor or unsatisfactory. Not recommended without extensive and realistic testing.
- - Indicates that this was not tested.
- # - For fluoropolymer. Indicates good chemical resistance but potential for excessive permeation.

MATERIALS CODE FOR HOSE CORE TUBES		PARKER'S PART NUMBERS
H	Elastomeric Polyester	55FR, 53FR, 53LT, PSH, HPSH, 3PSH, 560, 590, 593, 55LT, 530, 510C, 518C, 515H, HLB, 53GW
N	Polymeric Flexible Nylon	540N, 520N, 580N, H580N, 588N, PTH, 573X, 575X, 573XL, HP, HP8, PFT, 1035HT, 901N, CNG, CPS, 570A, 510, 510A, 515A, MSH
NC	Flexible Nylon Co-Polymer	
O	Flexible Polyolefin	540P
PFX	Proprietary Elastomer	1035A
PV	Flexible Polyvinyl Chloride (PVC)	GPH, GPV
TFE	Fluoropolymer PTFE	919, 929, 939/939B, 943B, 919U, 929BJ
MATERIALS CODE FOR HOSE COVERS		
HF	Elastomeric Low Temperature Polyester	55LT, 53LT, 3CNGLT, 4CNGLT, 5CNGLT
HFR	Flame Resistant Polyester	55FR, 53FR
N	Polymeric Flexible Nylon	PFT, 510
OC	Polyolefin Copolymer	1038, 1041
PFX	Proprietary Elastomer	518C, 1035HT
PV	Flexible Polyvinyl Chloride (PVC)	GPH, GPV
U	Polyurethane	All except GPH, 55LT, 53LT, 518C, PFT, 510, and PTFE hoses
UFR	Flame Resistant Urethane	3CNGFR, 4CNGFR, 5CNGFR
MATERIALS CODE FOR TUBING AND TRUE SEAL FITTING COMPONENTS		
A	Acetal	TrueSeal Fittings
B-N	Buna N (Nitrile) O-Rings	O-Rings in TrueSeal and Fast & Tite
EPDM	Ethylene Propylene	O-Rings in TrueSeal and Fast & Tite
F	Kynar	TrueSeal Fittings
FRPE	Flame Resistant Polyethylene	FRPE
HDPE	High Density Polyethylene	HDPE
N	Polymeric Flexible Nylon	NN, NB; colors, PFT
NR	Unplasticized Nylon	NNR, NBR
PE	Linear Low Density Polyethylene	E, EB, PE
PP	Polypropylene	PP, PPB, PPC
PV	Flexible Polyvinyl Chloride (PVC)	PV
TFE	Fluoropolymer PTFE	TFE
U	Polyurethane	U
V	Viton O-Rings	O-Rings in TrueSeal and Fast & Tite

Hydraulic & Pneumatic Hose & Fit.
 PTFE Hose & Fittings
 Thermoplastic Tubing
 Coiled Air Hose, Fittings & Accessories
 Truck (Fleet) Products
 Tooling & Equipment
 Hose Accessories
 Technical & Design Information
 Approvals & Guides
 Alphanumeric Index



Media to Hose Material Compatibility Guide

MEDIA	H	N	U/HF UFR	PV	NC	O	OC	PFX	HFR	FEP	TFE
Acetaldehyde	G	L	L	P	-	L	P	L	G	G	G
Acetic Acid Glacial	L	L	L	G	P	G	L	L	L	L	G
Acetone	L	G	P	P	G	P	P	P	L	G	G
Acetylene	2	2	2	2	2	2	2	2	2	2	2
Air (4)	G	G	G	G	G	G	G	G	G	G	G
Ammonium Chloride	G	P	G	G	P	G	G	G	G	L	G
Ammonium Hydroxide	L	G	P	L	-	G	G	P	L	G	G
Anhydrous Ammonia	P	P	P	P	P	P	P	P	P	8	8
Aniline	P	P	P	P	P	L	P	P	P	G	G
Animal Oils (6)	G	G	G	G	G	P	P	G	G	-	G
Aromatic Hydrocarbons	L	G	L	P	G	P	-	L	L	-	G
Asphalt	G	G	G	G	G	L	L	G	G	L	G
Baygon (insecticide)	L	G	P	-	-	-	-	P	L	-	G
Beer	G	G	G	G	-	G	G	G	G	G	G
Benzene	L	G	L	P	L	P	P	L	L	G	G
Brake Fluid (DOT #3)	-	G	P	P	-	P	P	P	-	-	G
Butane (2) (4)	G	G	L	L	P	L	P	L	G	#	#
Butter (6)	G	G	G	G	-	G	G	G	G	-	G
Calcium Chloride	G	3	G	L	3	G	G	G	G	G	G
Carbon Dioxide (4)	G	G	G	G	G	G	G	G	G	#	#
Carbon Monoxide (4)	G	3	G	G	3	L	-	G	G	#	#
Carbon Tetrachloride	L	G	P	L	G	P	P	P	L	G	G
Castor Oil	G	L	L	G	L	P	P	L	G	-	G
Chlorinated Hydrocarbon Base Fluids	L	G	L	P	-	-	-	L	L	-	G
Chlorinated Petroleum Oil	G	G	L	-	L	-	-	L	G	-	-
Chlorinated Solvents	P	3	P	L	3	L	L	P	P	-	G
Chlorine, Gaseous, Dry	P	P	P	G	P	L	P	P	P	#	P
Chlordane (Insecticide)	L	G	P	-	-	-	-	P	L	-	-
Chloroform	P	P	P	P	P	P	P	P	P	G	G
Chromic Acid	P	3	P	G	P	3	L	P	P	L	G
Citric Acid Solutions	G	G	L	G	G	G	G	L	G	G	G
Crude Petroleum Oil	G	G	G	G	G	P	P	G	G	-	G
Cyclohexane (2)	G	G	G	-	-	P	P	G	G	G	G
Cygon (Insecticide)	L	G	P	-	-	-	-	P	L	-	-
Diazin (insecticide)	L	-	P	L	-	-	-	-	-	-	-
Diesel Fuel (2)	G	G	G	L	G	P	P	G	G	-	G
Diester Oils	L	G	P	P	-	P	P	P	L	-	G
Enamels	G	G	G	L	-	L	L	G	G	-	G
Ethanol (6)	G	G	L	L	L	G	G	L	G	-	G
Ethers	L	G	P	L	G	L	P	P	L	G	G
Ethylene Glycol	L	G	L	G	G	G	G	L	G	G	G
Ethylene Oxide	G	G	L	P	-	L	L	L	G	#	#
Fatty Acids	G	G	3	G	G	L	L	3	G	G	G
Formaldehyde	L	L	P	L	L	G	L	P	L	G	G
Formic Acid	P	P	P	G	P	G	G	P	P	G	G

Hydraulic & Pneumatic Hose & Fit.

PTFE Hose & Fittings

Thermoplastic Tubing

Coiled Air Hose, Fittings & Accessories

Truck (Fleet) Products

Tooling & Equipment

Hose Accessories

Technical & Design Information

Approvals & Guides

Alphanumeric Index



Media to Hose Material Compatibility Guide

MEDIA	H	N	U/HF UFR	PV	NC	O	OC	PFX	HFR	FEP	TFE
Freon 12 (5)	P	G	L	G	G	L	-	L	P	#	#
Freon 22 (5)	P	G	L	G	G	L	-	L	P	#	#
Fruit Juices	G	G	G	G	-	G	G	G	G	-	G
Fuel Oil (2)	G	G	L	L	G	P	P	L	G	G	G
Gas (Oil) (2)	G	G	G	G	G	P	P	G	G	-	G
Gas (Natural) (4)	2	2	2	2	2	2	2	2	2	2	2
Gasoline (2)	G	G	3	P	G	P	P	3	G	G	G
Glue	3	3	3	3	3	3	3	3	3	3	3
Glycerin	G	G	L	G	G	G	G	L	G	G	G
Glycols (to 135°F)	L	G	L	G	G	-	-	L	G	G	G
Grease (petroleum base)	G	G	G	G	G	L	L	G	G	-	G
Heptachlor (insecticide)	L	G	P	L	-	P	P	P	L	-	G
Hexane (2)	G	G	G	L	G	P	P	G	G	G	G
Houghto Safe-600 Series (hydraulic fluid)	G	G	L	G	G	G	L	L	G	-	G
Houghto Safe-1000 Series (phosphate esters)	L	G	P	G	G	P	P	P	L	-	G
Hydraulic Fluid (petroleum base)	G	G	G	G	G	L	L	G	G	L	G
Hydraulic Fluid (phosphate ester base)	L	G	L	L	G	P	P	P	L	-	G
Hydraulic Fluid (water glycol base)	G	G	G	L	G	-	-	G	G	-	G
Hydraulic Oil (Petroleum base)	G	G	G	G	G	L	P	G	G	L	G
Hydrochloric Acid.	P	L	P	L	P	L	P	P	P	G	G
Hydrofluoric Acid	P	P	P	L	P	L	P	P	P	G	G
Hydrogen, Gaseous (2) (4) (5)	G	G	G	G	G	G	G	G	#	#	
Hydrolube (hydraulic fluid/water glycol base)	G	G	L	G	G	G	G	L	G	-	G
IRUS 902 (hydraulic fluid/water-oil emulsion)	G	G	G	G	G	L	P	G	G	-	G
Isocyanates (2)	L	L	L	P	-	L	P	L	L	-	G
IsoOctane (2)	G	G	G	L	G	L	P	L	G	G	G
Isopropyl Alcohol	G	G	L	L	G	G	L	L	G	G	G
Kerosene (2)	G	G	L	L	G	L	P	P	G	G	G
Ketones	L	G	P	P	G	G	P	P	L	G	G
Lacquer Solvents	L	G	P	P	3	L	3	P	L	L	G
Lactic Acid	P	G	P	G	G	G	G	P	P	G	G
Lime (calcium oxide)	G	G	G	G	-	G	G	G	G	G	G
Lindol (hydraulic fluid/phosphate esters)	L	G	P	-	-	-	-	P	L	-	G
Linseed Oil	G	G	G	L	G	L	P	G	G	G	G
LP - Gas	2	2	2	2	2	2	2	2	2	2	2
Lubricating Oils (diester base)	L	G	P	-	G	-	-	P	L	-	G
Lubricating Oils (Petroleum base)	G	G	G	G	G	L	P	G	G	G	G
Malathion (insecticide)	L	G	P	-	-	-	-	P	L	-	G
Magnesium Hydroxide	L	G	L	G	-	G	G	L	L	G	G
Magnesium Salts	-	G	G	G	-	G	-	G	-	-	G

Hydraulic & Pneumatic Hose & Fit.

PTFE Hose & Fittings

Thermoplastic Tubing

Coiled Air Hose, Fittings & Accessories

Truck (Fleet) Products

Tooling & Equipment

Hose Accessories

Technical & Design Information

Approvals & Guides

Alphanumeric Index



Media to Hose Material Compatibility Guide

MEDIA	H	N	U/HF UFR	PV	NC	O	OC	PFX	HFR	FEP	TFE
Mercury	G	G	G	G	G	G	G	G	G	G	G
Meropa Oil (sulphur base)	G	G	-	-	-	-	-	-	-	-	G
Methane	2	2	2	2	2	2	2	2	2	2	2
Methanol	G	G	P	P	G	L	P	P	G	-	G
Methoxychlor (insecticide)	L	G	P	-	-	-	-	P	L	-	G
Methyl Alcohol (6)	G	G	P	P	G	L	P	P	G	G	G
Methylene Chloride	P	L	P	L	P	L	P	P	P	G	G
Methyl Ethyl Ketone (MEK)	L	G	P	P	G	G	L	P	L	G	G
Methyl Ethyl Ketone Peroxide (MEKP)	-	L	P	-	-	-	-	P	-	-	G
Methyl Isobutyl Ketone (MIBK)	L	G	P	P	G	L	P	P	L	G	G
Milk (6)	G	G	G	G	-	G	G	G	G	G	G
Mineral Oil	G	G	G	G	G	L	P	G	G	G	G
Mineral Spirits	P	-	L	P	-	-	-	L	P	-	G
Motor Oils	G	G	G	G	G	-	-	G	G	G	G
Naphtha	L	G	P	P	G	P	P	P	L	G	G
Natural Gas (4)	2	2	2	2	2	2	2	2	2	2	2
Nitric Acid	P	P	P	L	P	P	P	P	P	L	G
Nitrobenzene	P	G	P	P	G	P	P	P	P	G	G
Nitrogen, Gaseous (4) (5)	G	G	G	G	G	G	G	G	G	G	G
Nitrous Oxide	-	L	-	G	-	L	-	G	-	#	#
Oil (SAE)	G	G	G	G	G	L	L	G	G	-	G
Oil of Turpentine	G	G	P	G	G	P	P	P	G	-	G
Oleic Acid	G	G	G	L	G	L	L	G	G	G	G
OS 45 Type 3 Hydraulic Fluid (silicate esters)	L	G	L	P	-	P	P	L	L	-	-
Oxygen, Gaseous (4) (5) (6)	G	G	G	G	G	G	G	G	G	G	G
Ozone	L	P	L	G	P	L	G	P	L	G	G
Paint Solvents (oil base)	L	G	L	P	-	P	P	L	L	-	G
Paint (Oil Base) (7)	G	G	G	P	-	L	P	G	G	-	G
Pentane (2)	G	G	L	L	-	P	P	L	G	G	G
Perchloric Acid	P	P	P	L	P	P	P	P	P	L	G
Perchloroethylene	P	P	P	L	P	P	P	P	P	-	G
Petroleum Ether	-	2	2	P	2	P	P	2	-	2	2
Petroleum Oils	G	G	G	G	G	L	P	G	G	-	G
Phenols	P	P	P	L	P	P	P	P	P	-	G
Phosphate Esters (above 135°F)	P	G	P	P	-	P	P	P	L	-	G
Phosphate Esters (to 135°F)	G	G	P	P	G	P	P	P	G	-	G
Polyol Esters	L	G	P	P	-	-	-	P	L	-	G
Potassium Hydroxide, 50%	P	P	P	L	-	L	L	P	P	G	G
Propane (4) (5)	2	2	2	2	2	2	2	2	2	2	2
Propylene Glycol	-	-	G	G	-	G	L	-	-	G	G
Pydraul F-9, 150, 160 (to 135°F)	G	G	P	P	G	P	P	P	G	-	G
Pydraul 312C, 625 (to 135°F)	P	G	P	P	G	P	P	P	G	-	G
Quintolubric 822 Fluid	-	G	G	-	-	-	-	-	-	-	G
Salt Water	3	3	3	3	3	3	3	3	3	G	G

Hydraulic &
Pneumatic
Hose & Fit.

PTFE
Hose &
Fittings

Thermoplastic
Tubing

Coiled Air Hose,
Fittings
& Accessories

Truck (Fleet)
Products

Tooling &
Equipment

Hose
Accessories

Technical &
Design
Information

Approvals &
Guides

Alphanumeric
Index



MEDIA	H	N	U/HF UFR	PV	NC	O	OC	PFX	HFR	FEP	TFE
Sevin (insecticides in water)	G	G	G	-	-	-	-	G	G	-	G
Silicone Greases	G	G	G	G	G	-	-	G	G	-	G
Silicone Oils	G	G	G	G	G	-	-	G	G	-	G
Skydrol 500 & 7000	L	G	P	P	G	P	P	P	L	G	G
Soap Solutions	G	G	G	G	G	G	G	G	G	G	G
Soda Water	G	G	G	G	G	3	3	G	G	-	G
Sodium Borate	G	G	G	G	G	G	G	G	G	G	G
Sodium Carbonate	3	3	3	3	3	3	3	3	3	3	3
Sodium Chloride Solutions	G	G	G	G	3	G	-	G	G	G	G
Sodium Hydroxide, 50%	L	P	P	L	P	L	L	P	L	G	G
Sodium Hypochlorite	L	P	P	L	-	3	3	P	L	G	G
Steam	P	P	P	P	P	P	P	P	P	G	G
Stoddard Solvent	P	G	P	L	G	P	P	P	P	G	G
Straight Synthetic Oils (phosphate esters)	L	G	P	P	G	-	-	P	L	-	G
Sulfur	G	G	G	G	-	L	G	G	G	G	G
Sulfur Dioxide	P	L	L	L	-	P	-	L	P	G	G
Sulfur Hexafluoride Gas (4) (5)	G	G	G	G	-	G	-	G	G	-	G
Sulphuric Acid	P	P	P	3	P	P	P	P	P	-	G
Toluene	L	G	L	P	G	P	P	P	L	G	G
Toloul	L	G	L	P	G	P	P	P	L	-	G
Transmission Fluid	G	G	G	P	G	-	-	G	G	-	G
Trichloroethylene	P	L	P	L	G	P	P	P	P	G	G
Trisodium Phosphate Solutions	L	G	P	G	G	G	G	P	L	G	G
Turpentine	G	G	L	L	G	P	P	P	G	G	G
Ucon (hydraulic fluid-water glycol base)	G	G	L	G	G	-	-	L	G	-	G
Varnish	G	G	G	P	G	G	L	G	G	-	G
Vinegar (6)	L	G	L	G	G	G	G	L	L	G	G
Water (to 135°F) (6)	G	G	G	G	G	G	G	L	G	G	G
Water (above 135°F) (6)	P	G	P	L	-	P	P	P	P	L	G
Water Glycols (to 135°F)	L	G	L	G	G	L	L	L	G	-	G
Water Glycols (above 135°F)	P	G	P	L	-	P	P	P	P	-	G
Water in oil Emulsions (to 135°F)	G	G	L	G	G	-	-	L	G	-	G
Water in oil Emulsions (above 135°F)	P	G	P	L	-	-	-	P	P	-	G
Whiskey, Wines (6)	G	G	L	G	G	G	G	G	G	G	G
Wood Oils	G	G	L	G	G	-	-	G	G	-	G
Xylene	L	G	P	P	G	P	P	P	L	G	G
Zinc Chloride	G	G	G	G	P	G	G	G	G	G	G

Footnotes for Fluid Compatibility Guides: (1) The Fluid Compatibility Guides are simplified rating tabulations based on immersion tests at 75°F. Higher temperatures tend to reduce ratings. Since final selection depends on pressure, fluid and ambient temperature and other factors not known to Parker Hannifin Co., no performance guarantee is expressed or implied. Ratings do not imply compliance with specialized codes such as FDA, NSF, AGA or UL and do not cover possible fluid discoloration, taste or odor effects. For conveying foodstuffs use FDA sanctioned materials, and for potable water use NSF listed materials. For chemicals not listed, or for advice on particular applications, please consult Product Engineering, Parflex Div., Ravenna, Ohio. (2) Hose applications for these fluids must take into account legal and insurance regulations. This does not imply AGA or UL compliance. (3) Satisfactory at some concentrations and temperatures, unsatisfactory in others. (4) For high pressure gases, the cover should be pinpricked and the pressure must not be released quickly. Chain or restrain the hose to prevent personal injury in the event of damage or failure. (5) Chemical compatibility does not imply low permeation rates. Consult the Parker factory for a recommendation for your specific requirement. (6) Does not imply NSF or FDA compliance. (7) Chemical compatibility does not imply acceptability for use in airless paint spray applications. These applications require a special conductive hose. (8) Teflon is chemically compatible with Anhydrous Ammonia. However, extreme caution must be used in dealing with Anhydrous Ammonia since it can cause severe injuries such as blindness and/or chemical burns.

Hydraulic & Pneumatic Hose & Fit.

PTFE Hose & Fittings

Thermoplastic Tubing

Coiled Air Hose, Fittings & Accessories

Truck (Fleet) Products

Tooling & Equipment

Hose Accessories

Technical & Design Information

Approvals & Guides

Alphanumeric Index



Media to Plastic Tubing Material Compatibility

MEDIA	PE	HDPE	PP	N	NR	PV	U	FRPE	FEP	PFA	TFE
Acetone	P	L	G	G	G	P	P	L	G	G	G
Acetyl Bromide	L	L	L	P	P	P	-	-	-	-	-
Acetyl Chloride	L	L	L	P	P	P	-	-	G	G	G
Air	G	G	G	G	G	G	G	G	G	G	G
Alcohols	G	G	G	G	G	L	L	G	G	G	G
Aluminum Salts	G	G	G	G	G	G	G	G	-	-	-
Ammonia	G	G	G	G	G	G	G	L	-	-	-
Amyl Acetate	G	G	G	G	G	P	L	-	G	G	G
Aniline	L	G	L	P	P	P	P	-	G	G	G
Animal Oils (6)	P	L	L	G	G	G	G	-	-	-	G
Arsenic Salts	G	G	G	G	G	G	G	G	-	-	-
Aromatic Hydrocarbons	P	L	L	G	G	P	L	P	-	-	G
Barium Salts	G	G	G	G	G	G	G	G	-	-	-
Benzaldehyde	P	L	L	L	L	P	L	P	G	G	G
Benzene	P	L	L	G	G	P	L	P	G	G	G
Benzyl Alcohol	P	G	L	L	L	G	L	P	G	G	G
Bleaching Liquors	G	L	G	L	L	L	L	-	-	-	-
Boric Acid Solutions	G	G	G	G	G	G	G	G	G	G	G
Bromine	L	L	P	P	P	F	P	-	G	L	G
Butane (2)	L	G	G	G	G	L	P	-	#	#	#
Butanol	G	G	G	G	G	G	G	G	-	-	-
Butyl Acetate	G	G	L	G	G	P	L	G	G	G	G
Calcium Hypochlorite	L	L	P	P	L	L	P	L	G	G	G
Calcium Salts	G	G	G	G	G	G	G	G	-	-	-
Carbon Dioxide	G	G	G	G	G	G	G	G	#	#	#
Carbon Disulfide	L	L	L	L	L	P	L	-	#	#	#
Carbon Tetrachloride	P	P	L	L	L	L	P	P	G	G	G
Caustic Potash	G	G	G	G	G	L	G	-	G	G	G
Caustic Soda	G	G	G	G	G	L	G	-	G	L	G
Chloracetic Acid	L	G	L	L	L	P	P	-	G	L	G
Chlorine (Dry)	L	L	L	P	P	G	P	-	#	#	#
Chlorine (Wet)	L	L	L	P	P	G	L	-	G	G	G
Chlorobenzene	P	L	L	L	L	P	L	P	G	G	G
Chloroform	P	L	P	P	P	P	P	P	G	G	G
Chromic Acid	L	L	L	P	P	G	P	-	L	G	G
Copper Salts	G	G	G	G	G	G	G	G	-	-	-
Cresol	P	L	L	P	P	L	P	P	G	G	G
Cyclohexanone	L	L	L	L	L	P	P	-	G	G	G
Ethers	L	L	P	G	G	L	P	-	G	G	G
Ethyl Acetate	G	G	G	G	G	P	L	-	G	G	G
Ethyl Alcohol	G	G	G	L	L	L	G	G	-	-	-
Ethylamine	L	G	L	L	L	P	L	-	-	-	-
Ethyl Bromide	P	L	L	L	L	P	-	P	-	-	-
Ethyl Chloride	P	L	P	L	L	P	-	P	G	G	G
Fatty Acids	L	L	L	G	G	L	L	P	G	G	G

Hydraulic & Pneumatic Hose & Fit.

PTFE Hose & Fittings

Thermoplastic Tubing

Coiled Air Hose, Fittings & Accessories

Truck (Fleet) Products

Tooling & Equipment

Hose Accessories

Technical & Design Information

Approvals & Guides

Alphanumeric Index



Media to Plastic Tubing Material Compatibility

MEDIA	PE	HDPE	PP	N	NR	PV	U	FRPE	FEP	PFA	TFE
Ferric Salts	G	G	G	G	G	G	G	-	-	-	-
Formaldehyde	G	G	G	L	L	L	P	-	G	G	G
Formic Acid	G	G	G	P	P	G	P	G	G	G	G
Freon	L	L	L	G	G	P	L	-	#	#	#
Gasoline (2)	P	G	L	G	G	P	L	P	G	G	G
Glucose	G	G	G	G	G	G	G	G	G	G	G
Glycerin	G	G	G	G	G	G	L	G	G	G	G
Hydriodic Acid	L	G	G	P	P	G	-	-	-	-	-
Hydrochloric Acid. (Conc.)	L	G	G	L	L	L	P	-	G	L	G
Hydrochloric Acid. (Med. Conc.)	L	G	G	L	L	L	P	-	G	L	G
Hydrofluoric Acid	L	L	G	P	P	L	P	-	G	-	G
Hydrogen Peroxide (Conc)	L	G	L	L	L	L	G	-	-	-	-
Hydrogen Peroxide (Dil.)	L	G	L	G	G	G	G	-	-	-	-
Hydrogen Sulfide	G	G	G	G	G	G	P	-	G	G	G
Iodine	L	G	G	G	G	L	L	-	G	G	G
Kerosene (2)	L	L	L	G	G	L	L	-	G	G	G
Ketones	G	G	G	G	G	P	P	-	G	G	G
Lacquer Solvents	L	L	L	G	G	P	-	-	L	G	G
Lactic Acid	G	G	G	G	G	G	G	-	G	G	G
Lead Acetate	G	G	G	G	G	G	G	-	G	G	G
Linseed Oil	L	G	G	G	G	L	G	-	G	G	G
Magnesium Salts	G	G	G	G	G	G	G	-	-	-	G
Naphtha	L	L	L	G	G	P	L	G	G	G	G
Natural Gas	L	L	L	G	G	G	G	-	2	2	2
Nickel Salts	G	G	G	G	G	G	G	-	-	-	-
Nitric Acid (Conc.)	P	L	P	P	P	L	P	G	L	L	G
Nitric Acid (Dil.)	P	G	L	L	L	G	P	P	L	L	G
Nitrobenzene	P	L	G	L	L	P	P	P	G	G	G
Nitrogen Oxides	L	L	G	L	L	G	-	-	-	-	-
Nitrous Acid	L	L	G	L	L	G	L	-	G	G	G
Oils (Animal and Mineral)	L	L	L	G	G	L	G	-	G	G	G
Oils (Vegetable)	L	L	L	G	G	L	G	-	G	G	G
Oxygen (5) (6)	G	G	G	G	G	G	G	G	G	G	G
Perchloric Acid	P	G	L	P	P	L	P	P	L	G	G
Phenols	P	G	G	P	P	L	P	P	-	-	G
Potassium Salts	G	G	G	G	G	G	G	G	-	-	-
Pyridine	L	L	L	L	L	P	P	-	G	G	G
Silver Nitrate	G	G	G	G	G	G	G	G	G	G	G
Soap Solutions	G	G	G	G	G	G	G	G	G	G	G
Sodium Salts	G	G	G	G	G	G	G	G	-	-	-
Stearic Acid	L	L	L	G	G	P	L	-	G	G	G
Sulfur Chloride	L	L	P	L	L	L	-	-	G	G	G
Sulfuric Acid (Conc.)	P	G	G	P	P	L	P	P	-	-	-
Sulfuric Acid (Dil.)	P	G	G	L	L	G	L	P	-	-	-
Sulfurous Acid	P	G	L	L	L	G	L	P	G	G	G

Hydraulic & Pneumatic Hose & Fit.

PTFE Hose & Fittings

Thermoplastic Tubing

Coiled Air Hose, Fittings & Accessories

Truck (Fleet) Products

Tooling & Equipment

Hose Accessories

Technical & Design Information

Approvals & Guides

Alphanumeric Index



Media to Plastic Tubing Material Compatibility

MEDIA	PE	HDPE	PP	N	NR	PV	U	FRPE	FEP	PFA	TFE
Tannic Acid	G	G	G	G	G	G	P	-	G	G	G
Tanning Extracts	G	G	G	G	G	G	P	-	-	-	-
Titanium Salts	G	G	G	G	G	G	G	G	-	-	-
Toluene	P	L	P	G	G	P	L	P	G	G	G
Trichloroacetic Acid	L	L	L	P	P	P	P	-	-	-	-
Trichloroethylene	P	L	P	L	L	P	P	P	G	G	G
Turpentine	P	P	L	G	G	L	L	-	G	G	G
Urea	G	G	G	G	G	G	G	-	G	L	G
Uric Acid	G	G	G	G	G	G	G	-	G	G	G
Water (6)	G	G	G	G	G	G	G	G	G	G	G
Xylene	P	L	P	G	G	P	P	P	G	G	G
Zinc Chloride	G	G	G	G	G	G	G	-	G	L	G

Footnotes for Fluid Compatibility Guides: (1) The Fluid Compatibility Guides are simplified rating tabulations based on immersion tests at 75°F. Higher temperatures tend to reduce ratings. Since final selection depends on pressure, fluid and ambient temperature and other factors not known to Parker Hannifin Co., no performance guarantee is expressed or implied. Ratings do not imply compliance with specialized codes such as FDA, NSF, AGA or UL and do not cover possible fluid discoloration, taste or odor effects. For conveying foodstuffs use FDA sanctioned materials, and for potable water use NSF listed materials. For chemicals not listed, or for advice on particular applications, please consult Product Engineering, Parflex Div., Ravenna, Ohio. (2) Hose applications for these fluids must take into account legal and insurance regulations. This does not imply AGA or UL compliance. (3) Satisfactory at some concentrations and temperatures, unsatisfactory in others. (4) For high pressure gases, the cover should be pinpricked and the pressure must not be released quickly. Chain or restrain the hose to prevent personal injury in the event of damage or failure. (5) Chemical compatibility does not imply low permeation rates. Consult the Parker factory for a recommendation for your specific requirement. (6) Does not imply NSF or FDA compliance. (7) Chemical compatibility does not imply acceptability for use in airless paint spray applications. These applications require a special conductive hose. (8) Fluoropolymer is chemically compatible with Anhydrous Ammonia. However, extreme caution must be used in dealing with Anhydrous Ammonia since it can cause severe injuries such as blindness and/or chemical burns.

Hydraulic & Pneumatic Hose & Fit.

PTFE Hose & Fittings

Thermoplastic Tubing

Coiled Air Hose, Fittings & Accessories

Truck (Fleet) Products

Tooling & Equipment

Hose Accessories

Technical & Design Information

Approvals & Guides

Alphanumeric Index

Hydraulic & Pneumatic Hose & Fit.

PTFE Hose & Fittings

Thermoplastic Tubing

Coiled Air Hose, Fittings & Accessories

Truck (Fleet) Products

Tooling & Equipment

Hose Accessories

Technical & Design Information

Approvals & Guides

Alphanumeric Index

Lined area for notes, consisting of multiple horizontal lines across the page.



Approvals & Guides

Government & Agency Approval.....292

Parker Safety Guide 293-295

Hydraulic &
Pneumatic
Hose & Fit.

PTFE
Hose &
Fittings

Thermoplastic
Tubing

Coiled Air Hose,
Fittings
& Accessories

Truck (Fleet)
Products

Tooling &
Equipment

Hose
Accessories

Technical &
Design
Information

Approvals &
Guides

Alphanumeric
Index

Hydraulic & Pneumatic Hose & Fit.
PTFE Hose & Fittings
Thermoplastic Tubing
Coiled Air Hose, Fittings & Accessories
Truck (Fleet) Products
Tooling & Equipment
Hose Accessories
Technical & Design Information
Approvals & Guides
Alphanumeric Index

Agency and Specifications	Approved Parflex Products
Flame Resistance: MSHA 1C 40/28 UL94V-0 UL94V-2 UL94HB USCG, 46CFR SAEJ1942	83FR 55FR, 53FR FRPE NN, NB, NR, NBR (Wall Thickness Above .033") 520N, 540N, 560, 590, 919 (With Fire Sleeve) 919 (With Fire Sleeve)
Dry Food Contact: FDA, CFR21 Part 177	E, PP, PV, 540P, BTH, HTL, GPH-FDA, Fast & Tite N and P, ParBarb N and P, TrueSeal™, FEP (Natural), 919, 929
Natural Gas Service: European Safety Standard (TUV) Kraftfahrt-Bundesamt ECE R110 Requirement Vehicles and Dispensing Systems ANSI IAS NGV4.2 - CSA 12.52	5CNG-3, 5CNG-8 3CNG, 4CNG, 5CNG, 3CNGLT, 4CNGLT, 5CNGLT, 3CNGFR, 4CNGFR, 5CNGFR
Potable Water, Liquid Foods: NSF Standard 51* NSF Standard 61 Naval Standard MIL-767C	E, PP, Fast & Tite N and P, ParBarb N and P, TrueSeal™, BTH, HTL, GPH-FDA E Series Polyethylene Tubing, TrueSeal Acetal Fittings 540P
Hydraulic Service: SAE 100R7 SAE 100R8 SAE 100R14 SAE 100R18	540N, 55FR, 55LT, 510, 510A, 510C, 518C 520N, 580N, 588N 919 53LT, 538LT
WASTEC WRP05-1996 (Waste Equipment Technology Association)	S4, S5, S6, S9
International Standards: ISO (International Standards Organization) ISO 3949-1 ISO 3449-2	540N 520N, 580N, 588N
DIN (Deutsches Institut Für Normung): DIN 20-078 (excluding hex size dimensions) DIN 24951-2KT DIN 20022-1SN (performance requirements) DIN 73378, DIN 74324, DIN 74323	55 and 58 SERIES METRIC FITTINGS 515H, 540N, 558H 560 DINLP, DINHP, DINUHP, Metric BRAKCOIL®, Dollycoil™, Duo-Coil™, SliderCoil™
Refrigeration: UL1963, R502	510A-2, 510
Transportation: SAE J844 (FMVSS106) SAE J1394	PFT-A, PFT-B, BRAKCOIL®, DollyCoil™, Duo-Coil™, SliderCoil™ PFTM-A, PFTM-B
Electrical Non-Conductivity: SAE J517, Pitman E-00094 Ontario Hydro, SAE J517 DNV**:	518C, HP8 518C, 528N, 588N
Det Norski (Norwegian) Veritas Marine Steel Ships, Mobile Offshore and Fixed Offshore Drilling Units Cert. No. P-11464 Cert. No. P-11463 Cert. No. P-11462 Cert. No. P-11465 Cert. No. P-11466 Cert. No. P-10717 Cert. No. P-10674, P-9566 Cert. No. P-11419	520N, 580N, 588N, H580N 518C 540N 573X, 575X HP, HP8 590, 593, 1032 560 573LH, 575LH
Breathing Air Applications: CGA (Compressed Gas Association)- G-7.1-1997 Grade E Breathing Air NFPA 1901	526BA 526BA

* Indicates that products shown have been tested and certified by NSF International to the requirements of Standard 51. NSF does not express or imply an approval on any product.

** Products certified to DNV type approval 5.791.70 only with Parflex 55, 58, LV, LH, HP fittings.





Parker Safety Guide for Selecting and Using Hose, Tubing, Fittings, and Related Accessories

Parker Publication No. 4400-B.1

Revised: May 2002

WARNING: Failure or improper selection or improper use of hose, tubing, fittings, assemblies or related accessories ("Products") can cause death, personal injury and property damage. Possible consequences of failure or improper selection or improper use of these Products include but are not limited to:

- Fittings thrown off at high speed.
- High velocity fluid discharge.
- Explosion or burning of the conveyed fluid.
- Electrocutation from high voltage electric power lines.
- Contact with suddenly moving or falling objects that are controlled by the conveyed fluid.
- Injections by high-pressure fluid discharge.
- Dangerously whipping Hose.
- Contact with conveyed fluids that may be hot, cold, toxic or otherwise injurious.
- Sparking or explosion caused by static electricity buildup or other sources of electricity.
- Sparking or explosion while spraying paint or flammable liquids.
- Injuries resulting from inhalation, ingestion or exposure to fluids.

Before selecting or using any of these Products, it is important that you read and follow the instructions below. Only Hose from Parker's Stratoflex Products Division is approved for in flight aerospace applications, and no other Hose can be used for such in flight applications.

1.0 GENERAL INSTRUCTIONS

1.1 Scope: This safety guide provides instructions for selecting and using (including assembling, installing, and maintaining) these Products. For convenience, all rubber and/or thermoplastic products commonly called "hose" or "tubing" are called "Hose" in this safety guide. All assemblies made with Hose are called "Hose Assemblies". All products commonly called "fittings" or "couplings" are called "Fittings". All related accessories (including crimping and swaging machines and tooling) are called "Related Accessories". This safety guide is a supplement to and is to be used with, the specific Parker publications for the specific Hose, Fittings and Related Accessories that are being considered for use.

1.2 Fail-Safe: Hose, and Hose Assemblies and Fittings can and do fail without warning for many reasons. Design all systems and equipment in a fail-safe mode, so that failure of the Hose or Hose Assembly or Fitting will not endanger persons or property.

1.3 Distribution: Provide a copy of this safety guide to each person that is responsible for selecting or using Hose and Fitting products. Do not select or use Parker Hose or Fittings without thoroughly reading and understanding this safety guide as well as the specific Parker publications for the products considered or selected.

1.4 User Responsibility: Due to the wide variety of operating conditions and applications for Hose and Fittings, Parker and its distributors do not represent or warrant that any particular Hose or Fitting is suitable for any specific end use system. This safety guide does not analyze all technical parameters that must be considered in selecting a product. The user, through its own analysis and testing, is solely responsible for:

- Making the final selection of the Hose and Fitting.
- Assuring that the user's requirements are met and that the application presents no health or safety hazards.
- Providing all appropriate health and safety warnings on the equipment on which the Hose and Fittings are used.
- Assuring compliance with all applicable government and industry standards.

1.5 Additional Questions: Call the appropriate Parker technical service department if you have any questions or require any additional information. See the Parker publication for the product being considered or used, or call 1-800-CPARKER, or go to www.parker.com, for telephone numbers of the appropriate technical service department.

2.0 HOSE AND FITTING SELECTION INSTRUCTIONS

2.1 Electrical Conductivity: Certain applications require that the Hose be nonconductive to prevent electrical current flow. Other applications require the Hose and the Fitting and the Hose/Fitting interface to be sufficiently conductive to drain off static electricity. Extreme care must be exercised when selecting Hose and Fittings for these or any other applications in which electrical conductivity or nonconductivity is a factor.

The electrical conductivity or nonconductivity of Hose and Fittings is dependent upon many factors and may be susceptible to change. These factors include but are not limited to the various materials used to make the Hose and the Fittings, Fitting finish (some Fitting finishes are electrically conductive while others are nonconductive), manufacturing methods (including moisture control), how the Fittings contact the Hose,

age and amount of deterioration or damage or other changes, moisture content of the Hose at any particular time, and other factors.

The following are considerations for electrically nonconductive and conductive Hose. For other applications consult the individual catalog pages and the appropriate industry or regulatory standards for proper selection.

2.1.1 Electrically Nonconductive Hose: Certain applications require that the Hose be nonconductive to prevent electrical current flow or to maintain electrical isolation. For these applications that require Hose to be electrically nonconductive, including but not limited to applications near high voltage electric lines, only special nonconductive Hose can be used. The manufacturer of the equipment in which the nonconductive Hose is to be used must be consulted to be certain that the Hose and Fittings that are selected are proper for the application. Do not use any Parker Hose or Fitting for any such application requiring nonconductive Hose, including but not limited to applications near high voltage electric lines, unless (i) the application is expressly approved in the Parker technical publication for the product, (ii) the Hose is marked "nonconductive", and (iii) the manufacturer of the equipment on which the Hose is to be used specifically approves the particular Parker Hose and Fitting for such use.

2.1.2 Electrically Conductive Hose: Parker manufacturers special Hose for certain applications that require electrically conductive Hose. Parker manufactures special Hose for conveying paint in airless paint spraying applications. This Hose is labeled "Electrically Conductive Airless Paint Spray Hose" on its layline and packaging. This Hose must be properly connected to the appropriate Parker Fittings and properly grounded in order to dissipate dangerous static charge buildup, which occurs in all airless paint spraying applications. Do not use any other Hose for airless paint spraying, even if electrically conductive. Use of any other Hose or failure to properly connect the Hose can cause a fire or an explosion resulting in death, personal injury, and property damage.

Parker manufactures a special Hose for certain compressed natural gas ("CNG") applications where static electricity buildup may occur. Parker CNG Hose assemblies comply with AGA Requirements 1-93, "Hoses for Natural Gas Vehicles and Fuel Dispensers". This Hose is labeled "Electrically Conductive for CNG Use" on its layline and packaging. This Hose must be properly connected to the appropriate Parker Fittings and properly grounded in order to dissipate dangerous static charge buildup, which occurs in, for example, high velocity CNG dispensing or transfer. Do not use any other Hose for CNG applications where static charge buildup may occur, even if electrically conductive. Use of other Hoses in CNG applications or failure to properly connect or ground this Hose can cause a fire or an explosion resulting in death, personal injury, and property damage. Care must also be taken to protect against CNG permeation through the Hose wall. See section 2.6, Permeation, for more information. Parker CNG Hose is intended for dispenser and vehicle use at a maximum temperature of 180°F. Parker CNG Hose should not be used in confined spaces or unventilated areas or areas exceeding 180°F. Final assemblies must be tested for leaks. CNG Hose Assemblies should be tested on a monthly basis for conductivity per AGA 1-93.

Parker manufactures special Hose for aerospace in flight applications. Aerospace in flight applications employing Hose to transmit fuel,



Hydraulic & Pneumatic Hose & Fit.
PTFE Hose & Fittings
Thermoplastic Tubing
Coiled Air Hose, Fittings & Accessories
Truck (Fleet) Products
Tooling & Equipment
Hose Accessories
Technical & Design Information
Approvals & Guides
Alphanumeric Index

lubricating fluids and hydraulic fluids require a special Hose with a conductive inner tube. This Hose for in flight applications is available only from Parker's Stratoflex Products Division. Do not use any other Parker Hose for in flight applications, even if electrically conductive. Use of other Hoses for in flight applications or failure to properly connect or ground this Hose can cause a fire or an explosion resulting in death, personal injury, and property damage. These Hose assemblies for in flight applications must meet all applicable aerospace industry, aircraft engine, and aircraft requirements.

- 2.2 **Pressure:** Hose selection must be made so that the published maximum recommended working pressure of the Hose is equal to or greater than the maximum system pressure. Surge pressures or peak transient pressures in the system must be below the published maximum working pressure for the Hose. Surge pressures and peak pressures can usually only be determined by sensitive electrical instrumentation that measures and indicates pressures at millisecond intervals. Mechanical pressure gauges indicate only average pressures and cannot be used to determine surge pressures or peak transient pressures. Published burst pressure ratings for Hose is for manufacturing test purposes only and is no indication that the Product can be used in applications at the burst pressure or otherwise above the published maximum recommended working pressure.
- 2.3 **Suction:** Hoses used for suction applications must be selected to insure that the Hose will withstand the vacuum and pressure of the system. Improperly selected Hose may collapse in suction application.
- 2.4 **Temperature:** Be certain that fluid and ambient temperatures, both steady and transient, do not exceed the limitations of the Hose. Temperatures below and above the recommended limit can degrade Hose to a point where a failure may occur and release fluid. Properly insulate and protect the Hose Assembly when routing near hot objects (e.g. manifolds). Do not use any Hose in any application where failure of the Hose could result in the conveyed fluids (or vapors or mist from the conveyed fluids) contacting any open flame, molten metal, or other potential fire ignition source that could cause burning or explosion of the conveyed fluids or vapors.
- 2.5 **Fluid Compatibility:** Hose Assembly selection must assure compatibility of the Hose tube, cover, reinforcement, and Fittings with the fluid media used. See the fluid compatibility chart in the Parker publication for the product being considered or used. This information is offered only as a guide. Actual service life can only be determined by the end user by testing under all extreme conditions and other analysis. Hose that is chemically compatible with a particular fluid must be assembled using Fittings and adapters containing likewise compatible seals.
- 2.6 **Permeation:** Permeation (that is, seepage through the Hose) will occur from inside the Hose to outside when Hose is used with gases, liquid and gas fuels, and refrigerants (including but not limited to such materials as helium, diesel fuel, gasoline, natural gas, or LPG). This permeation may result in high concentrations of vapors which are potentially flammable, explosive, or toxic, and in loss of fluid. Dangerous explosions, fires, and other hazards can result when using the wrong Hose for such applications. The system designer must take into account the fact that this permeation will take place and must not use Hose if this permeation could be hazardous. The system designer must take into account all legal, government, insurance, or any other special regulations which govern the use of fuels and refrigerants. Never use a Hose even though the fluid compatibility is acceptable without considering the potential hazardous effects that can result from permeation through the Hose Assembly. Permeation of moisture from outside the Hose to inside the Hose will also occur in Hose assemblies, regardless of internal pressure. If this moisture permeation would have detrimental effects (particularly, but not limited to refrigeration and air conditioning systems), incorporation of sufficient drying capacity in the system or other appropriate system safeguards should be selected and used.
- 2.7 **Size:** Transmission of power by means of pressurized fluid varies with pressure and rate of flow. The size of the components must be adequate to keep pressure losses to a minimum and avoid damage due to heat generation or excessive fluid velocity.
- 2.8 **Routing:** Attention must be given to optimum routing to minimize inherent problems (kinking or flow restriction due to Hose collapse, twisting of the Hose, proximity to hot objects or heat sources).
- 2.9 **Environment:** Care must be taken to insure that the Hose and Fittings are either compatible with or protected from the environment (that is, surrounding conditions) to which they are exposed. Environmental conditions including but not limited to ultraviolet radiation, sunlight, heat, ozone, moisture, water, salt water, chemicals, and air pollutants can cause degradation and premature failure.
- 2.10 **Mechanical Loads:** External forces can significantly reduce Hose life

or cause failure. Mechanical loads which must be considered include excessive flexing, twist, kinking, tensile or side loads, bend radius, and vibration. Use of swivel type Fittings or adapters may be required to insure no twist is put into the Hose. Unusual applications may require special testing prior to Hose selection.

- 2.11 **Physical Damage:** Care must be taken to protect Hose from wear, snagging, kinking, bending smaller than minimum bend radius, and cutting, any of which can cause premature Hose failure. Any Hose that has been kinked or bent to a radius smaller than the minimum bend radius, and any Hose that has been cut or is cracked or is otherwise damaged, should be removed and discarded.
- 2.12 **Proper End Fitting:** See instructions 3.2 through 3.5. These recommendations may be substantiated by testing to industry standards such as SAE J517 for hydraulic applications, or MIL-A-5070, AS1339, or AS3517 for Hoses from Parker's Stratoflex Products Division for aerospace applications.
- 2.13 **Length:** When establishing a proper Hose length, motion absorption, Hose length changes due to pressure, and Hose and machine tolerances and movement must be considered.
- 2.14 **Specifications and Standards:** When selecting Hose and Fittings, government, industry, and Parker specifications and recommendations must be reviewed and followed as applicable.
- 2.15 **Hose Cleanliness:** Hose components may vary in cleanliness levels. Care must be taken to insure that the Hose Assembly selected has an adequate level of cleanliness for the application.
- 2.16 **Fire Resistant Fluids:** Some fire resistant fluids that are to be conveyed by Hose require use of the same type of Hose as used with petroleum base fluids. Some such fluids require a special Hose, while a few fluids will not work with any Hose at all. See instructions 2.5 and 1.5. The wrong Hose may fail after a very short service. In addition, all liquids but pure water may burn fiercely under certain conditions, and even pure water leakage may be hazardous.
- 2.17 **Radiant Heat:** Hose can be heated to destruction without contact by such nearby items as hot manifolds or molten metal. The same heat source may then initiate a fire. This can occur despite the presence of cool air around the Hose.
- 2.18 **Welding or Brazing:** When using a torch or arc-welder in close proximity to hydraulic lines, the hydraulic lines should be removed or shielded with appropriate fire resistant materials. Flame or weld spatter could burn through the Hose and possibly ignite escaping fluid resulting in a catastrophic failure. Heating of plated parts, including Hose Fittings and adapters, above 450°F [232°C] such as during welding, brazing, or soldering may emit deadly gases.
- 2.19 **Atomic Radiation:** Atomic radiation affects all materials used in Hose assemblies. Since the long-term effects may be unknown, do not expose Hose assemblies to atomic radiation.
- 2.20 **Aerospace Applications:** The only Hose and Fittings that may be used for in flight aerospace applications are Hose available from Parker's Stratoflex Products Division. Do not use any other Hose or Fittings for in flight applications. Do not use any Hose or Fittings from Parker's Stratoflex Products Division with any other Hose or Fittings, unless expressly approved in writing by the engineering manager or chief engineer of Stratoflex Products Division and verified by the user's own testing and inspection to aerospace industry standards.
- 2.21 **Unlocking Couplings:** Ball locking couplings or other couplings with disconnect sleeves can unintentionally disconnect if they are dragged over obstructions or if the sleeve is bumped or moved enough to cause disconnect. Threaded couplings should be considered where there is a potential for accidental uncoupling.

3.0 HOSE AND FITTING ASSEMBLY AND INSTALLATION INSTRUCTIONS

- 3.1 **Component Inspection:** Prior to assembly, a careful examination of the Hose and Fittings must be performed. All components must be checked for correct style, size, catalog number, and length. The Hose must be examined for cleanliness, obstructions, blisters, cover looseness, kinks, cracks, cuts or any other visible defects. Inspect the Fitting and sealing surfaces for burrs, nicks, corrosion or other imperfections. Do NOT use any component that displays any signs of nonconformance.
- 3.2 **Hose and Fitting Assembly:** Do not assemble a Parker Fitting on a Parker Hose that is not specifically listed by Parker for that Fitting, unless authorized in writing by the engineering manager or chief engineer of the appropriate Parker division. Do not assemble a Parker Fitting on another manufacturer's Hose or a Parker Hose on another manufacturer's Fitting unless (i) the engineering manager or chief engineer of the appropriate Parker division approves the Assembly in writing or that combination is expressly approved in the appropriate Parker literature for the specific Parker product, and (ii) the user verifies the Assembly and the application through analysis and testing. For Parker Hose that does not specify a Parker Fitting, the user is solely



responsible for the selection of the proper Fitting and Hose Assembly procedures. See instruction 1.4.

The Parker published instructions must be followed for assembling the Fittings on the Hose. These instructions are provided in the Parker Fitting catalog for the specific Parker Fitting being used, or by calling 1-800-CPARKER, or at www.parker.com.

3.3 Related Accessories: Do not crimp or swage any Parker Hose or Fitting with anything but the listed swage or crimp machine and dies in accordance with Parker published instructions. Do not crimp or swage another manufacturer's Fitting with a Parker crimp or swage die unless authorized in writing by the engineering manager or chief engineer of the appropriate Parker division.

3.4 Parts: Do not use any Parker Fitting part (including but not limited to socket, shell, nipple, or insert) except with the correct Parker mating parts, in accordance with Parker published instructions, unless authorized in writing by the engineering manager or chief engineer of the appropriate Parker division.

3.5 Field Attachable/Permanent: Do not reuse any field attachable (Field Attachable) Hose Fitting that has blown or pulled off a Hose. Do not reuse a Parker permanent Hose Fitting (crimped or swaged) or any part thereof. Complete Hose Assemblies may only be reused after proper inspection under section 4.0. Do not assemble Fittings to any previously used hydraulic Hose that was in service, for use in a fluid power application.

3.6 Pre-Installation Inspection: Prior to installation, a careful examination of the Hose Assembly must be performed. Inspect the Hose Assembly for any damage or defects. Do NOT use any Hose Assembly that displays any signs of nonconformance.

3.7 Minimum Bend Radius: Installation of a Hose at less than the minimum listed bend radius may significantly reduce the Hose life. Particular attention must be given to preclude sharp bending at the Hose to Fitting juncture. Any bending during installation at less than the minimum bend radius must be avoided. If any Hose is kinked during installation, the Hose must be discarded.

3.8 Twist Angle and Orientation: Hose Assembly installation must be such that relative motion of machine components does not produce twisting.

3.9 Securement: In many applications, it may be necessary to restrain, protect, or guide the Hose to protect it from damage by unnecessary flexing, pressure surges, and contact with other mechanical components. Care must be taken to insure such restraints do not introduce additional stress or wear points.

3.10 Proper Connection of Ports: Proper physical installation of the Hose Assembly requires a correctly installed port connection insuring that no twist or torque is transferred to the Hose when the Fittings are being tightened or otherwise during use.

3.11 External Damage: Proper installation is not complete without insuring that tensile loads, side loads, kinking, flattening, potential abrasion, thread damage, or damage to sealing surfaces are corrected or eliminated. See instruction 2.10.

3.12 System Checkout: All air entrapment must be eliminated and the system pressurized to the maximum system pressure (at or below the Hose maximum working pressure) and checked for proper function and freedom from leaks. Personnel must stay out of potential hazardous areas while testing and using.

3.13 Routing: The Hose Assembly should be routed in such a manner so if a failure does occur, the escaping media will not cause personal injury or property damage. In addition, if fluid media comes in contact with hot surfaces, open flame, or sparks, a fire or explosion may occur. See section 2.4.

4.0 HOSE AND FITTING MAINTENANCE AND REPLACEMENT INSTRUCTIONS

4.1 Even with proper selection and installation, Hose life may be significantly reduced without a continuing maintenance program. The severity of the application, risk potential from a possible Hose failure, and experience with any Hose failures in the application or in similar applications should determine the frequency of the inspection and the replacement for the Products so that Products are replaced before any failure occurs. A maintenance program must be established and followed by the user and, at minimum, must include instructions 4.2 through 4.7.

4.2 Visual Inspection Hose/Fitting: Any of the following conditions require immediate shut down and replacement of the Hose Assembly:

- Fitting slippage on Hose,
- Damaged, cracked, cut or abraded cover (any reinforcement exposed);
- Hard, stiff, heat cracked, or charred Hose;
- Cracked, damaged, or badly corroded Fittings;

- Leaks at Fitting or in Hose;
- Kinked, crushed, flattened or twisted Hose; and
- Blistered, soft, degraded, or loose cover.

4.3 Visual Inspection All Other: The following items must be tightened, repaired, corrected or replaced as required:

- Leaking port conditions;
- Excess dirt buildup;
- Worn clamps, guards or shields; and
- System fluid level, fluid type, and any air entrapment.

4.4 Functional Test: Operate the system at maximum operating pressure and check for possible malfunctions and leaks. Personnel must avoid potential hazardous areas while testing and using the system. See section 2.2.

4.5 Replacement Intervals: Hose assemblies and elastomeric seals used on Hose Fittings and adapters will eventually age, harden, wear and deteriorate under thermal cycling and compression set. Hose Assemblies and elastomeric seals should be inspected and replaced at specific replacement intervals, based on previous service life, government or industry recommendations, or when failures could result in unacceptable downtime, damage, or injury risk. See section 1.2.

4.6 Hose Inspection and Failure: Hydraulic power is accomplished by utilizing high-pressure fluids to transfer energy and do work. Hoses, Fittings, and Hose Assemblies all contribute to this by transmitting fluids at high pressures. Fluids under pressure can be dangerous and potentially lethal and, therefore, extreme caution must be exercised when working with fluids under pressure and handling the Hoses transporting the fluids. From time to time, Hose Assemblies will fail if they are not replaced at proper time intervals. Usually these failures are the result of some form of misapplication, abuse, wear, or failure to perform proper maintenance. When Hoses fail, generally the high-pressure fluids inside escape in a stream which may or may not be visible to the user. Under no circumstances should the user attempt to locate the leak by "feeling" with their hands or any other part of their body. High-pressure fluids can and will penetrate the skin and cause severe tissue damage and possibly loss of limb. Even seemingly minor hydraulic fluid injection injuries must be treated immediately by a physician with knowledge of the tissue damaging properties of hydraulic fluid.

If a Hose failure occurs, immediately shut down the equipment and leave the area until pressure has been completely released from the Hose Assembly. Simply shutting down the hydraulic pump may or may not eliminate the pressure in the Hose Assembly. Many times check valves, etc., are employed in a system and can cause pressure to remain in a Hose Assembly even when pumps or equipment are not operating. Tiny holes in the Hose, commonly known as pinholes, can eject small, dangerously powerful but hard to see streams of hydraulic fluid. It may take several minutes or even hours for the pressure to be relieved so that the Hose Assembly may be examined safely.

Once the pressure has been reduced to zero, the Hose Assembly may be taken off the equipment and examined. It must always be replaced if a failure has occurred. Never attempt to patch or repair a Hose Assembly that has failed. Consult the nearest Parker distributor or the appropriate Parker division for Hose Assembly replacement information. Never touch or examine a failed Hose Assembly unless it is obvious that the Hose no longer contains fluid under pressure. The high-pressure fluid is extremely dangerous and can cause serious and potentially fatal injury.

4.7 Elastomeric seals: Elastomeric seals will eventually age, harden, wear and deteriorate under thermal cycling and compression set. Elastomeric seals should be inspected and replaced.

4.8 Refrigerant gases: Special care should be taken when working with refrigeration systems. Sudden escape of refrigerant gases can cause blindness if the escaping gases contact the eye and can cause freezing or other severe injuries if it contacts any other portion of the body.

4.9 Compressed natural gas (CNG): Parker CNG Hose Assemblies should be tested after installation and before use, and at least on a monthly basis per AGA 1-93 Section 4.2 "Visual Inspection Hose/Fitting". The recommended procedure is to pressurize the Hose and check for leaks and to visually inspect the Hose for damage.

Caution: **Matches, candles, open flame or other sources of ignition shall not be used for Hose inspection. Leak check solutions should be rinsed off after use.**

Hydraulic & Pneumatic Hose & Fit.

PTFE Hose & Fittings

Thermoplastic Tubing

Coiled Air Hose, Fittings & Accessories

Truck (Fleet) Products

Tooling & Equipment

Hose Accessories

Technical & Design Information

Approvals & Guides

Alphanumeric Index



Part Number	Page	Part Number	Page	Part Number	Page	Part Number	Page
0		10695.....	169	14155.....	62	1FV91N.....	159
015301.....	218, 221, 223	106HY.....	118	14158.....	88	1G155.....	72
015302.....	221	106LV.....	41	14191N.....	155	1G158.....	97
015303.....	221	10755.....	57	141HY.....	120	1G255.....	72
015304.....	221	10758.....	82	14K93N.....	167	1G258.....	97
015305.....	221	10791N.....	152	15555.....	43	1GJHY.....	122
015306.....	218, 219, 220	107HY.....	115	15858.....	43	1GU55.....	71
015307.....	218, 219, 220	10855.....	57	16191N.....	156	1GU58.....	96
015308.....	220, 221	10858.....	82	16755.....	63	1GUHY.....	128
015309.....	220	10891N.....	153	16758.....	88	1HV91N.....	163
015310.....	221	108HY.....	121	16791N.....	156	1J055.....	65
015411.....	221	108MS.....	42	16792.....	104	1J058.....	92
015412.....	221	10GHY.....	116	167HY.....	123	1J0HY.....	124
015413.....	221	10LHY.....	117	16955.....	64	1J155.....	66
015414.....	221	11155.....	58	16958.....	89	1J158.....	91
015415.....	221	11158.....	83	16991N.....	157	1J158H.....	91
025349.....	220	11192.....	103	16992.....	104	1J191N.....	160
025399.....	221, 223	111HY.....	122	169HY.....	123	1J1HY.....	126
025411.....	219	11255.....	58	17791N.....	157	1J755.....	67
090.....	149	11258.....	83	177HY.....	121	1J758.....	91
		11355.....	59	17991N.....	158	1J758H.....	91
		11358.....	84	179HY.....	121	1J791N.....	161
1		113HY.....	114	19255.....	76	1J793N.....	168
10155.....	53	11D55.....	74	19258.....	100	1J7HY.....	125
10158.....	78	11D58.....	99	19291N.....	164	1J955.....	67
10158H.....	78	11L55.....	59	193HY.....	120	1J958.....	92
10191N.....	150	11L58.....	84	1AL55.....	69	1J958H.....	92
10193N.....	165	11LHY.....	115	1AL55N.....	68	1J991N.....	161
101HY.....	114	12891N.....	153	1AL58.....	94	1J993N.....	168
101SQ.....	110	12892.....	103	1AL58N.....	93	1J9HY.....	126
10255.....	53	128HY.....	123	1AL91N.....	158	1JC55.....	65
10258.....	78	129HY.....	124	1B155.....	76	1JC58.....	90
10293N.....	165	13491N.....	154	1B158.....	100	1JC58H.....	90
102HY.....	115	134HY.....	122	1B255.....	77	1JC91N.....	162
10355.....	54	134MS.....	42	1B258.....	101	1JC93N.....	168
10358.....	79	13755.....	60	1B291N.....	164	1JCHY.....	124
1035A.....	35	13758.....	85	1C655.....	73	1JS55.....	64
1035HT.....	35	13758H.....	85	1C658.....	98	1JS58.....	89
10391N.....	150	13791N.....	154	1C955.....	73	1JS58H.....	89
103HY.....	117	13793N.....	166	1C958.....	98	1JSHY.....	125
10455.....	55	137HY.....	119	1D055.....	73	1JSLV.....	41
10458.....	80	13955.....	61	1D058.....	98	1L955.....	63
10555.....	55	13958.....	86	1D0HY.....	127	1L958.....	87
10558.....	80	13958H.....	86	1D255.....	74	1MC93N.....	167
105HY.....	116	13991N.....	155	1D258.....	99	1MU55.....	71
10655.....	56	13993N.....	166	1D955.....	75	1MU58.....	96
10658.....	81	139HY.....	119	1D958.....	101	1P655.....	69
10658H.....	81	13D55.....	75	1D9HY.....	127	1P658.....	94
10691N.....	151	13D58.....	102	1FC93N.....	167	1P691N.....	159
10691NRD.....	151	13DHY.....	127	1FN91N.....	159	1Q191N.....	162
10693N.....	165	13E55.....	54	1FU55.....	70	1TU55.....	68
10694.....	169	13E58.....	79	1FU58.....	95	1TU58.....	93

Note: When seeking hose assembly and crimp specification information on any Parflex hose, visit: www.parker.com/parflex, click on the Services → Crimp Source folder.



Hydraulic & Pneumatic Hose & Fit.

PTFE Hose & Fittings

Thermoplastic Tubing

Coiled Air Hose, Fittings & Accessories

Truck (Fleet) Products

Tooling & Equipment

Hose Accessories

Technical & Design Information

Approvals & Guides

Alphanumeric Index

Hydraulic & Pneumatic Hose & Fit.

PTFE Hose & Fittings

Thermoplastic Tubing

Coiled Air Hose, Fittings & Accessories

Truck (Fleet) Products

Tooling & Equipment

Hose Accessories

Technical & Design Information

Approvals & Guides

Alphanumeric Index

Part Number	Page	Part Number	Page	Part Number	Page	Part Number	Page
1TU91N	163	2C551	48	6-6CTXS	221	85C-061-PFD	222
1UT55	70	2C651	48	60 HAB	149	85C-0HP-PFD	223
1UT58	95	2C951	48	61 HAB	149	85C-OEP	223
1UTHY	128	2D051	49	631076	226	85C-R01-PFD	222, 224
1VH91N	163	2D251	49	631140	226	88C-082-PFD	222
1XUHY	128	2D951	51	631975	226	9	
2		3		662451	226	919	133
20090	149	316-PFD	226	662452	226	919B	133
20151	44	332T-115V	226	662453	226	919J	134
20190	142	3PSG	229	662454	226	919U	135
201BA	105	4		662455	226	929	136
201BG	108	432	226	6CTXS	221	929B	136
20351	44	432-115V	226	7		929BJ	137
203BA	105	5		702-OIL	232	939	138
203BG	108	510A	16	731512-Blue, Red	210	939B	138
20651	45	510C	17	731513-Blue, Red	210	943B	139
20690	142	515H	17	731516	210	94C-080-PFD	218, 219
206BA	106	518C	18	731522	210	950B	139
206BG	109	520N	19	731611-Blue, Red	210	A	
20851	45	526BA	33	731612-Blue, Red	210	AS-Y	230
20890	143	528N	19	741526	210	AUFS	204
208BA	106	53DM	20	741590-Blue, Red	210	B	
208MS	42	538LT	21	751597	210	B9	9
21151	46	53LT	20	751634	212	C	
213BG	109	540N	22	751641	210	CNG	32
21D51	50	540P	33	751655	210	D	
22890	141	55AG	229, 231	751656-Blk	210	D6	9
23490	143	55LT	23	751657	213	E	
23790	144	55SG	229, 231	751658-Blue, Red	213	E	177, 179
237BA	106	55SSG	229	751659	213	EB	177, 179
23951	46	56DH	34	751660-Blue, Red	213	F	
23990	145	560	14	8		FC	201
239BA	107	563	14	801048	211	FL	201
23D51	50	568DH	34	801595	211	FN	202
241BA	107	573X	23	801632	211	FR	202
24398	226	573XL	231, 282	80C-081-PFD	222	FRPE	180
2613	230	575X	24	80C-R01-PFD	222, 224	FS	198
26190	145	580661	226	811537	210, 212	FS-F	230
2625	230	580N	24	821072	250	H	
26790	146	588N	25	822011	221	H580N	24
26990	147	590	15	822012	221	H6	10
2740	230	593	15	822031	221		
27790	147	6		82C-061-PFD	222		
2799	230	6-2CTXS	221	82C-OEP	223		
27990	148			82C-R01	221		
29251	51			82C-R01-PFD	218, 219, 222, 224		
2B151	52			83C-081-PFD	222		
2B251	52			83FR	26		
2C351	47						
2C451	47						

Note: When seeking hose assembly and crimp specification information on any Parflex hose, visit: www.parker.com/parflex, click on the Services → Crimp Source folder.



Part Number	Page	Part Number	Page	Part Number	Page	Part Number	Page
HBR.....	228	S5.....	30				
HDPE.....	180	S6.....	31				
HFS.....	11	S9.....	31				
HFS2.....	11	SG.....	202				
HJK.....	27	SQ-101.....	217, 239, 253				
HLB.....	27	SQ Mender.....	110				
Hoze-Oil.....	232						
HPS.....	28	T					
HTB.....	12	TS.....	202				
HTFL.....	209	U					
HU.....	188	U.....	186, 187				
HUM.....	189	UC.....	202				
M		UFS.....	205				
M8.....	12	V					
MC.....	200	VBL.....	226, 240, 244				
MCB.....	206	VBS.....	226, 240, 244				
ME.....	200						
MG.....	230						
ML.....	201						
MLB.....	206						
MSH.....	28						
MTH.....	29						
N							
N.....	181, 182						
NB.....	181, 182						
NBR.....	184						
NN.....	181, 182						
NR.....	184						
P							
PAT.....	183						
PE.....	178						
PFT.....	208						
PFT-FL.....	209						
PP.....	185						
PPB.....	185						
PTC.....	226						
PTC-001-RB.....	226						
PTH.....	29						
PV.....	191						
R							
R6.....	13						
S							
S4.....	30						

Note: When seeking hose assembly and crimp specification information on any Parflex hose, visit: www.parker.com/parflex, click on the Services → Crimp Source folder.



Hydraulic & Pneumatic Hose & Fit.

PTFE Hose & Fittings

Thermoplastic Tubing

Coiled Air Hose, Fittings & Accessories

Truck (Fleet) Products

Tooling & Equipment

Hose Accessories

Technical & Design Information

Approvals & Guides

Alphanumeric Index

1. **Terms and Conditions of Sale:** All descriptions, quotations, proposals, offers, acknowledgments, acceptances and sales of Seller's products are subject to and shall be governed exclusively by the terms and conditions stated herein. Buyer's acceptance of any offer to sell is limited to these terms and conditions. Any terms or conditions in addition to, or inconsistent with those stated herein, proposed by Buyer in any acceptance of an offer by Seller, are hereby objected to. No such additional, different or inconsistent terms and conditions shall become part of the contract between Buyer and Seller unless expressly accepted in writing by Seller. Seller's acceptance of any offer to purchase by Buyer is expressly conditioned upon Buyer's assent to all the terms and conditions stated herein, including any terms in addition to, or inconsistent with those contained in Buyer's offer. Acceptance of Seller's products shall in all events constitute such assent.
 2. **Payment:** Payment shall be made by Buyer net 30 days from the date of delivery of the items purchased hereunder. Amounts not timely paid shall bear interest at the rate of 1-1/2% for each month or a portion thereof that Buyer is late in making payment. Any claims by Buyer for omissions or shortages in a shipment shall be waived unless Seller receives notice thereof within 30 days after Buyer's receipt of the shipment.
 3. **Delivery:** Unless otherwise provided on the face hereof, delivery shall be made F.O.B. Seller's plant. Regardless of the method of delivery, however, risk of loss shall pass to Buyer upon Seller's delivery to a carrier. Any delivery dates shown are approximate only and Seller shall have no liability for any delays in delivery.
 4. **Warranty:** Seller warrants that the items sold hereunder shall be free from defects in materials or workmanship for a period of 365 days from the date of shipment to Buyer, or 2,000 hours of use, whichever expires first. **THIS WARRANTY COMPRISES THE SOLE AND ENTIRE WARRANTY PERTAINING TO ITEMS PROVIDED HEREUNDER. SELLER MAKES NO OTHER WARRANTY, GUARANTEE, OR REPRESENTATION OF ANY KIND WHATSOEVER. ALL OTHER WARRANTIES, INCLUDING BUT NOT LIMITED TO, MERCHANTABILITY AND FITNESS FOR PURPOSE, WHETHER EXPRESS, IMPLIED, OR ARISING BY OPERATION OF LAW, TRADE USAGE, OR COURSE OF DEALING ARE HEREBY DISCLAIMED.**

NOTWITHSTANDING THE FOREGOING, THERE ARE NO WARRANTIES WHATSOEVER ON ITEMS BUILT OR ACQUIRED WHOLLY OR PARTIALLY, TO BUYER'S DESIGNS OR SPECIFICATIONS.
 5. **Limitation Of Remedy:** SELLER'S LIABILITY ARISING FROM OR IN ANY WAY CONNECTED WITH THE ITEMS SOLD OR THIS CONTRACT SHALL BE LIMITED EXCLUSIVELY TO REPAIR OR REPLACEMENT OF THE ITEMS SOLD, OR REFUND OF THE PURCHASE PRICE PAID BY BUYER, AT SELLER'S SOLE OPTION. IN NO EVENT SHALL SELLER BE LIABLE FOR ANY INCIDENTAL, CONSEQUENTIAL OR SPECIAL DAMAGES OF ANY KIND OR NATURE WHATSOEVER, INCLUDING BUT NOT LIMITED TO LOST PROFITS ARISING FROM OR IN ANY WAY CONNECTED WITH THIS AGREEMENT OR ITEMS SOLD HEREUNDER, WHETHER ALLEGED TO ARISE FROM BREACH OF CONTRACT, EXPRESS OR IMPLIED WARRANTY, OR IN TORT, INCLUDING WITHOUT LIMITATION, NEGLIGENCE, FAILURE TO WARN OR STRICT LIABILITY.
 6. **Changes, Reschedules and Cancellations:** Buyer may request to modify the designs or specifications for items sold hereunder as well as the quantities and delivery dates thereof, or may request to cancel all or part of an order, however, no such requested modification or cancellation shall become part of the contract between Buyer and Seller unless accepted by Seller in a written amendment to this Agreement. Acceptance of any such requested modification of cancellation shall be at Seller's discretion, and shall be upon such terms and conditions as Seller may require.
 7. **Special Tooling:** A tooling charge may be imposed for any special tooling, including without limitation, dies, fixtures, molds and patterns, acquired to manufacture items sold pursuant to this contract. Such special tooling shall be and remain Seller's property notwithstanding payment of any charges therefor by Buyer. In no event will Buyer acquire any interest in apparatus belonging to Seller which is utilized in the manufacture of the items sold hereunder, even if such apparatus has been specially converted or adapted for such manufacture and notwithstanding any charges paid by Buyer therefor. Unless otherwise
- agreed, Seller shall have the right to alter, discard or otherwise dispose of any special tooling or other property in its sole discretion at any time.
8. **Buyer's Property:** Any designs, tools, patterns, materials, drawings, confidential information or equipment furnished to Seller by Buyer, or any other items which become Buyer's property, may be considered obsolete and may be destroyed by Seller after two (2) consecutive years have elapsed without Buyer placing an order for the items which are manufactured using such property. Seller shall not be responsible for any loss or damage to such property while it is in Seller's possession or control.
 9. **Taxes:** Unless otherwise indicated, all prices and charges are exclusive of excise, sales, use, property, occupational or like taxes which may be imposed by any taxing authority upon the manufacture, sale or delivery of the items sold hereunder. If any such taxes must be paid by Seller, or if Seller is liable for the collection of such tax, the amount thereof shall be in addition to the amounts for the items sold. Buyer agrees to pay all such taxes or to reimburse Seller therefor upon receipt of its invoice. If Buyer claims exemption from any sales, use or other tax imposed by any taxing authority, Buyer shall save Seller harmless from and against any such tax, as well as any interest or penalties thereon which may be assessed if the items are held to be taxable.
 10. **Indemnity For Infringement of Intellectual Property Rights:** Seller shall have no liability for infringement of any patents, trademarks, copyrights, trade dress, trade secrets or similar rights except as provided in this Part 10. Seller will defend and indemnify Buyer against allegations of infringement of U.S. patents, U.S. trademarks, copyrights, trade dress and trade secrets (hereinafter 'Intellectual Property Rights'). Seller will defend at its expense and will pay the cost of any settlement or damages awarded in an action brought against Buyer based on an allegation that an item sold pursuant to this contract infringes the Intellectual Property Rights of a third party. Seller's obligation to defend and indemnify Buyer is contingent on Buyer notifying Seller within ten (10) days after Buyer becomes aware of such allegations of infringement, and Seller having sole control over the defense of any allegations or actions, including all negotiations for settlement or compromise. If an item sold hereunder is subject to a claim that it infringes the Intellectual Property Rights of a third party, Seller may, at its sole expense and option, procure for Buyer the right to continue using said item, replace or modify said item so as to make it noninfringing, or offer to accept return of said item and return the purchase price less a reasonable allowance for depreciation.

Notwithstanding the foregoing, Seller shall have no liability for claims of infringement based on information provided by Buyer, or directed to items delivered hereunder for which the designs are specified in whole or part by Buyer, or infringements resulting from the modification, combination or use in a system of any item sold hereunder. The foregoing provisions of this Part 10 shall constitute Seller's sole and exclusive liability and Buyer's sole and exclusive remedy for infringement of Intellectual Property Rights.

If a claim is based on information provided by Buyer or if the design for an item delivered hereunder is specified in whole or in part by Buyer, Buyer shall defend and indemnify Seller for all costs, expenses or judgements resulting from any claim that such item infringes any patent, trademark, copyright, trade dress, trade secret or any similar right.
 11. **Force Majeure:** Seller does not assume the risk of and shall not be liable for delay or failure to perform any of Seller's obligations by reason of circumstances beyond the reasonable control of Seller (hereinafter 'Events of Force Majeure'). Events of Force Majeure shall include without limitation, accidents, acts of God, strikes or labor disputes, acts, laws, rules or regulations of any government or government agency, fires, floods, delays or failures in delivery of carriers or suppliers, shortages of materials and any other cause beyond Seller's control.
 12. **Entire Agreement/Governing Law:** The terms and conditions set forth herein, together with any amendments, modifications and any different terms or conditions expressly accepted by Seller in writing, shall constitute the entire Agreement concerning the items sold, and there are no oral or other representations or agreements which pertain thereto. This Agreement shall be governed in all respects by the law of the State of Ohio. No actions arising out of the sale of the items sold hereunder or this Agreement may be brought by either party more than two (2) years after the cause of action accrues.

The items described in this document are hereby offered for sale at

Aerospace

Key Markets

- Commercial transports
- Military aircraft
- Regional transports
- Aircraft engines
- Business and general aviation

Key Products

- Flight control systems and components
- Hydraulic systems and components
- Fuel systems and components
- Pneumatic systems and components
- Inert oxygen generating systems
- Fluid metering, delivery and atomization devices
- Wheels and brakes
- Couplings, fittings, hoses and tubes



Automation

Key Markets

- Factory automation
- Transportation and automotive
- Life sciences and medical
- Machine tools
- Semiconductor and electronics

Key Products

- Pneumatic motion and control
- Air preparation
- Vacuum controls and sensors
- Electromechanical stepper and servo motors, drives, and controls
- Human machine interface
- Electric actuators, gantry robots, slides and linear motors
- Structural extrusion



Climate & Industrial Controls

Key Markets

- Refrigeration and air conditioning
- Transportation/mobile
- Process
- Industrial machinery
- Medical/life sciences
- Fuel cells
- Precision cooling

Key Products

- Pressure regulators
- Check, ball and service valves
- Value-added systems
- Thermostatic and expansion valves
- Electronic controllers
- Contaminant controls
- Heating/air conditioning hose
- Gerotors



Filtration

Key Markets

- Industrial machinery
- Process
- Mobile
- Marine
- Oil & gas
- Power generation and energy
- Transportation
- Food and beverage

Key Products

- Hydraulic, lubrication and coolant filters
- Process, chemical, water and microfiltration filters
- Compressed air and gas purification filters
- Condition monitoring
- Analytical gas generators
- Nitrogen, hydrogen and zero air generators
- Engine air, fuel, oil filtration and systems



Fluid Connectors

Key Markets

- Construction machinery
- Agriculture
- Transportation
- Mobile
- Industrial machinery
- Oil & gas

Key Products

- Rubber and thermoplastic hose
- Industrial hose
- Tube fittings and adaptors
- Tubing and plastic fittings
- Brass fittings and valves
- Hose couplings
- Quick disconnects



Hydraulics

Key Markets

- Construction machinery
- Agriculture
- Industrial machinery
- Oil & gas
- Truck hydraulics
- Power generation and energy

Key Products

- Hydraulic cylinders and accumulators
- Hydraulic valves and controls
- Hydraulic motors and pumps
- Power take-offs
- Hydraulic systems



Instrumentation

Key Markets

- Power generation
- Oil & gas
- Petrochemical
- Microelectronics
- Biopharmaceutical

Key Products

- Medium/high pressure fittings and valves
- Instrumentation fittings, valves, manifolds and regulators
- High purity fittings, valves and regulators
- Fluoropolymer fittings, valves, pumps and regulators
- Analytical systems



Seal

Key Markets

- Transportation
- Energy, oil & gas
- Semiconductor
- Aerospace
- Fluid power
- Life sciences
- Telecommunications

Key Products

- Elastomeric O-rings
- Homogeneous and inserted elastomeric shapes and diaphragms
- Metal and plastic retained composite seals
- Polymeric and plastic dynamic seals
- Rubber and plastic boots/bellows
- Extruded and precision-cut/fabricated elastomeric seals
- Thermoplastic engineered seals



Parker FCG Sales Offices & Service Centers (PSC)

Your complete source for quality tube fittings, hose & hose fittings, brass fittings & valves, quick-disconnect couplings, and assembly tools, locally-available from a worldwide network of authorized distributors.

Fittings & Couplings:

Available in inch and metric sizes covering SAE, BSP, DIN, GAZ, JIS and ISO thread configurations, manufactured from steel, stainless steel, brass, aluminum, nylon and thermoplastic.

Hose, Tubing and Bundles:

Available in a wide variety of sizes and materials including rubber, wire-reinforced, thermoplastic, hybrid and custom compounds.

Worldwide Availability:

Parker operates Fluid Connectors manufacturing locations and sales offices throughout North America, South America, Europe and Asia-Pacific.

For information, contact the nearest Regional Sales office listed, or call toll-free...

1-800-C-PARKER
(1-800-272-7537)

Central Region

Sales Office & Service Center
Hiawatha, IA
(319) 393-1221
(319) 393-1224 FAX

Cleveland Region

Sales Office
Cleveland, OH
(216) 896-2404
(216) 896-4022 FAX
Service Center
Toledo, OH
(419) 878-7000
(419) 878-7001 FAX
(419) 878-7420 (FCG Kit Operations) FAX

Great Lakes Region

Sales Office & Service Center
Otsego, MI
(269) 694-2550
(269) 692-6634 FAX

Louisville Service Center

Louisville, KY
(502) 937-1322
(502) 937-4180 FAX

Minneapolis Region

Sales Office
(763) 513-3535
(763) 544-3418 FAX
Service Center
Minneapolis, MN
(952) 469-5000
(952) 469-5729 FAX
Service Center
Oshkosh, WI
(920) 426-8471
(920) 426-8570 FAX

Northeast Region

Sales Office
Trenton, NJ
(609) 586-5151
(609) 586-6081 FAX

Pacific Region

Sales Office & Service Center
Portland, OR
(503) 283-1020
(503) 283-2201 FAX
Service Center
Buena Park, CA
(714) 522-8840
(714) 994-1183 FAX

Southeast Region

Sales Office & Service Center
Greensboro, NC
(336) 373-1761
(336) 378-0913 FAX for PSC
(336) 373-9069 FAX for Sales Office
Service Center
Conyers, GA
(770) 929-0330
(770) 929-0230 FAX

Southwest Region

Sales Office
Mansfield, TX
(817) 473-4431
(817) 453-8022 FAX

Canada

Sales Office & Service Center
Grimsby, ONT
(905) 945-2274
(905) 945-2203 FAX
(Contact Grimsby for other Service Center locations.)



Parker Hannifin Corporation
Parflex Division
1300 North Freedom Street
Ravenna, Ohio 44266
(330) 296-2871
www.parker.com/parflex

