

# ***polyflex***<sup>®</sup> **Hose Products**

*Ultra High Pressure Thermoplastic Hose*

*Catalog 4900 USA  
June 2003*

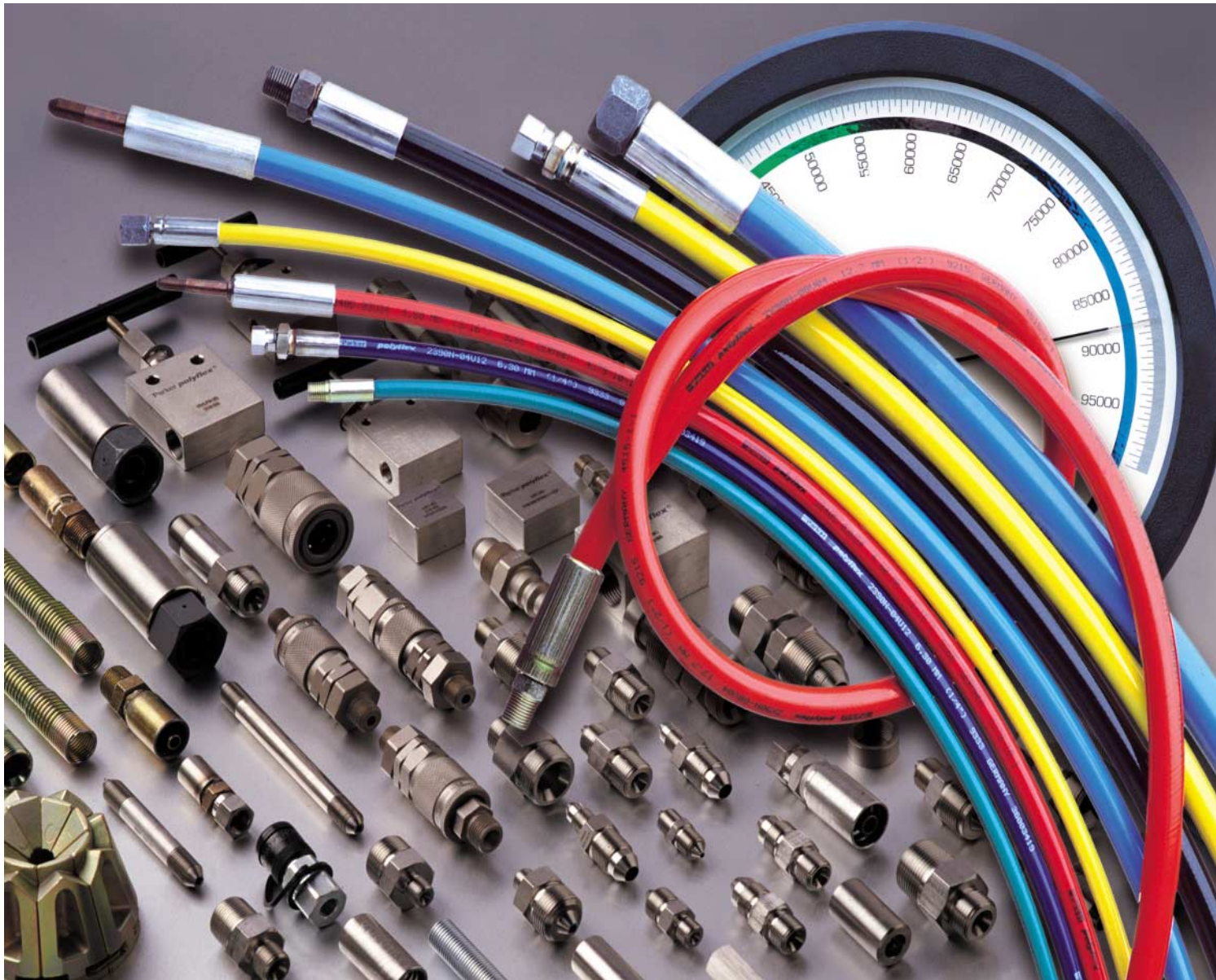

anything **Parker**  
**Possible.**<sup>™</sup>

**polyflex**<sup>®</sup>  
Table of Contents

---

General Information .....	Section A	<b>A</b>
<b>polyflex</b> <sup>®</sup> Hose and Fittings .....	Section B	<b>B</b>
High Pressure Adapters and Valves .....	Section C	<b>C</b>
Quick Couplings .....	Section D	<b>D</b>
Accessories/Tooling .....	Section E	<b>E</b>
Technical Information .....	Section F	<b>F</b>
Alphanumeric Index .....	Section G	<b>G</b>
Offer of Sale .....	G8	



## Table of Contents –Section A

Conversion Table .....	A2
Hose Selection Charts .....	A3
By Working Pressure 2.5:1 .....	A3
By Working Pressure 4:1 .....	A5
By Inside Diameter .....	A7
Hose Fitting Chart .....	A9
Hose Fitting Guide .....	A12
Hose Part Numbering System.....	A13
Hose End Fitting Part Numbering System .....	A13
Ordering Information .....	A14
Explanation of Symbols .....	A15

**A**

## Conversion Table of Old and New Part Numbers of **polyflex®** Hose

Old Numbers	New Numbers	Old Numbers	New Numbers
1002 MC *00	2010N-012V30	212 KL *00	2033T-08V70
1002 MC *01	2010N-016V30	216 KL *00	2033T-10V70
1002 MK *00	2020N-016V30	220 KL *00	2033T-12V70
1003 MK *01	2020N-02V30	225 KL *00	2033T-16V70
1004 MK *00	2X20N-025V30	2006-2 ST *00	2370N-04V01
1004 MK *01	2020N-0125V30	2008-2 ST *00	2370N05V01
1005 K *01	2040N-03V00	2010-2 ST *00	2370N-06V01
1006 K *01	2040N-04V00	2012-2 ST *00	2370H-08V01
1008 K *01	2040N-05V00	2006-2 STD *00	2370N-04-04V01V01
1010 K *01	2040N-06V00	2008-2 STD *00	2370N-05-05V01V01
1012 K *01	2040N-08V00	2010-2 STD *00	2370N-06-06V01V01
1016 K *01	2040N-10V00	2012-2 STD *00	2370H-08-08V01V01
1020 K *01	2040N-12V00	2006 ST *00	2245N-04V00
1025 K *01	2040N-16V00	2008 ST *00	2245N-05V00
105 KL *00	2030T-03V70	2010 ST *00	2245N-06V00
106 KL *00	2030T-04V70	2012 ST *00	2245N-08V00
108 KL *00	2030T-05V70	2016 ST *00	2245N-10V30
110 KL *00	2030T-06V70	2020 ST *00	2245N-12V30
112 KL *00	2030T-08V70	2025 ST *00	2245N-16V30
116 KL *00	2030T-10V70	2032 ST *00	2244N-20V30
120 KL *00	2030T-12V70	2104 ST *00	2244N-025V00
125 KL *00	2030T-16V70	2106 ST *00	2380N-04V00
1105 K *00	2040H-03V11	2110 ST *00	2244N-06V00
1106 K *00	2040H-04V11	2112 ST *00	2244N-08V10
1108 K *00	2040H-05V11	4004 ST *00	2440D-025V32
1110 K *00	2040H-06V11	4005 ST *00	2440D-03V32
1112 K *00	2040H-08V11	4006 ST *00	2440D-04V32
1116 K *00	2040H-10V11	4008 ST *00	2440N-05V32
1112 K *00	2040H-12V11	4010 ST *00	2440N-06V30
1125 K *00	2040H-16V11	4012 ST *00	2440N-08V30
1106 KD *00	2040H-04-04V11V11	4020 ST *00	2440N-12V30
1108 KD *00	2040H-0505V11V11	4025 ST *00	2440N-16V30
1110 KD *00	2040H-06-06V11V11	6004 ST *00	2640D-025V32
1112 KD *00	2040H-08-08V11V11	6005 ST *00	2640D-03V32
206 KL *00	2033T-04V70	6008 ST *00	2640D-05V32
208 KL *00	2-33T-05V70	6012 ST *00	2640D-08V32
210 KL *00	2033T-06V70	6020 ST *00	2640N-12V32

## Hose Selection Chart

By Working Pressure 2.5:1					
Working Pressure 2.5:1	Working Pressure 4:1	I.D. inch	O.D. inch	Hose Number	Page No.
6,380	3,990	1.25	1.73	2244N-20V30	B30
6,380	3,990	1.00	1.34	2245N-16V30	B45
6,380	3,987	0.76	1.12	2380F-12V07	B50
6,500	4,100	1.00	1.37	2390N-16V12	B69
6,500	4,100	1.00	1.37	2390N-16V13	B69
6,500	4,100	1.00	1.37	2390N-16V16	B69
6,960	4,350	0.75	1.13	2245N-12V30	B43
7,192	4,495	0.25	0.47	2040N-04V00	B6
7,540	4,710	0.50	0.81	2380F-08V07	B48
N/A	5,000	2.00	2.71	2440N-32V10	B89
8,100	5,575	0.81	1.14	2390N-12V03	B67
8,120	5,075	0.50	0.81	2245N-08V30	B41
8,700	5,440	0.40	0.67	2245N-06V00	B39
8,700	5,437	0.32	0.56	2380F-05V07	B47
9,280	5,800	0.08	0.20	2020N-02V30	B4
9,280	5,800	0.31	0.56	2245N-05V00	B37
10,000	N/A	2.00	3.35	2640N-32V80	B99
10,300	6,450	0.40	0.70	2390N-06V13	B63
10,400	6,500	0.50	0.81	2390N-08V12	B65
10,400	6,500	0.50	0.81	2390N-08V13	B65
10,400	6,500	0.50	0.81	2390N-08V16	B65
10,440	6,525	0.25	0.50	2245N-04V00	B33
10,440	6,525	0.25	0.50	2245N-04V02	B33
10,440	6,525	0.25	0.50	2245N-04V04	B33
11,020	6,890	0.08	0.20	2020N-012V30	B3
12,000	7,500	0.25	0.52	2390N-04V10	B60
12,000	7,500	0.25	0.52	2390N-04V12	B60
12,000	7,500	0.25	0.52	2390N-04V16	B60
12,760	7,970	0.50	0.89	2244N-08V10	B28
12,760	7,970	0.50	0.89	2244N-08V71	B28
13,040	8,150	0.32	0.52	2240D-05V32	B18
13,050	N/A	1.00	1.46	2440N-16V37	B87
13,050	N/A	1.00	1.46	2440N-16V71	B87
13,200	8,250	0.25	0.50	2380N-04V33	B55
13,600	8,500	0.32	0.62	2380N-05V00	B58
14,000	8,750	0.25	0.50	2243D-04V70	B23

**A**



## Hose Selection Chart

By Working Pressure 2.5:1 –continued					
Working Pressure 2.5:1	Working Pressure 4:1	I.D. inch	O.D. inch	Hose Number	Page No.
14,490	9,050	0.25	0.45	2240D-04V32	B15
14,500	N/A	0.81	1.19	2440N-12V37	B85
14,500	N/A	0.81	1.19	2440N-12V71	B85
15,080	N/A	0.50	0.91	2X90N-08V14	B113
15,950	9,970	0.12	0.28	2240D-02V32	B9
16,230	10,145	0.20	0.38	2240D-03V34	B13
16,240	10,150	0.17	0.36	2243D-025V70	B19
16,240	10,150	0.20	0.42	2243D-03V70	B20
16,240	10,150	0.20	0.42	2245D-03V32	B31
16,240	10,150	0.25	0.53	2380N-04V00	B52
16,240	10,150	0.25	0.53	2380N-04V02	B52
16,240	10,150	0.25	0.53	2380N-04V04	B52
16,240	10,150	0.25	0.53	2380N-04V71	B52
17,400	10,875	0.17	0.30	2240D-025V34	B10
17,400	10,870	0.17	0.38	2244N-025V00	B26
18,560	N/A	0.25	0.53	2X90N-04V14	B109
20,290	N/A	0.75	1.30	2640N-12V32	B97
20,290	N/A	0.75	1.30	2640N-12V71	B97
20,300	N/A	0.40	0.77	2440N-06V91	B82
20,400	N/A	0.50	0.88	2440N-08V37	B83
20,400	N/A	0.50	0.88	2440N-08V71	B83
21,750	N/A	0.32	0.61	2440D-05V37	B80
23,200	15,000	0.40	0.85	2X90N-06V14	B112
23,780	N/A	0.25	0.50	2440N-04V37	B77
23,780	N/A	0.25	0.50	2440N-04V71	B77
26,090	N/A	0.50	0.97	2640N-08V32	B95
26,100	N/A	0.20	0.45	2440D-03V37	B73
31,900	N/A	0.16	0.37	2440D-025V37	B71
36,000	N/A	0.50	*	2840D-08V30	B108
36,230	N/A	0.20	0.51	2640D-03V32	B93
36,230	N/A	0.32	0.67	2740D-05V32	B105
40,580	N/A	0.32	0.76	2840D-05V32	B107
40,600	N/A	0.16	0.45	2640D-025V32	B91
40,600	N/A	0.20	0.52	2740D-03V30	B103
45,000	N/A	0.16	0.48	2740D-025V30	B101
48,000	N/A	0.20	0.57	2840D-03V34	B106
60,000*	N/A	0.20	1.57	2840D-03V34*	B106

## Hose Selection Chart

By Working Pressure 4:1					
Working Pressure 4:1	Working Pressure 2.5:1	I.D. inch	O.D. inch	Hose Number	Page No.
3,987	6,380	0.76	1.12	2380F-12V07	B50
3,990	6,380	1.25	1.73	2244N-20V30	B30
3,990	6,380	1.00	1.34	2245N-16V30	B45
4,100	6,500	1.00	1.37	2390N-16V12	B69
4,100	6,500	1.00	1.37	2390N-16V13	B69
4,100	6,500	1.00	1.37	2390N-16V16	B69
4,350	6,960	0.75	1.13	2245N-12V30	B43
4,495	7,192	0.25	0.47	2040N-04V00	B6
4,710	7,540	0.50	0.81	2380F-08V07	B48
5,075	8,120	0.50	0.81	2245N-08V30	B41
5,437	8,700	0.32	0.56	2380F-05V07	B47
5,440	8,700	0.40	0.67	2245N-06V00	B39
5,575	8,100	0.81	1.14	2390N-12V03	B67
5,800	9,280	0.08	0.20	2020N-02V30	B4
5,800	9,280	0.31	0.56	2245N-05V00	B37
6,450	10,300	0.40	0.70	2390N-06V13	B63
6,500	10,400	0.50	0.81	2390N-08V12	B65
6,500	10,400	0.50	0.81	2390N-08V13	B65
6,500	10,400	0.50	0.81	2390N-08V16	B65
6,525	10,440	0.25	0.50	2245N-04V00	B33
6,525	10,440	0.25	0.50	2245N-04V02	B33
6,525	10,440	0.25	0.50	2245N-04V04	B33
6,890	11,020	0.08	0.20	2020N-012V30	B3
7,500	12,000	0.25	0.52	2390N-04V10	B60
7,500	12,000	0.25	0.52	2390N-04V12	B60
7,500	12,000	0.25	0.52	2390N-04V16	B60
7,970	12,760	0.50	0.89	2244N-08V10	B28
7,970	12,760	0.50	0.89	2244N-08V71	B28
8,150	13,040	0.32	0.52	2240D-05V32	B18
8,250	13,200	0.25	0.50	2380N-04V33	B55
8,500	13,600	0.32	0.62	2380N-05V00	B58
8,500	13,600	0.32	0.62	2380N-05V71	B58
8,750	14,000	0.25	0.50	2243D-04V70	B23
9,050	14,490	0.25	0.45	2240D-04V32	B15
9,970	15,950	0.12	0.28	2240D-02V32	B9
10,145	16,230	0.20	0.38	2240D-03V34	B13
10,150	16,240	0.17	0.36	2243D-025V70	B19

**A**



## Hose Selection Chart

By Working Pressure 4:1 –continued					
Working Pressure 4:1	Working Pressure 2.5:1	I.D. inch	O.D. inch	Hose Number	Page No.
10,150	16,240	0.20	0.42	2243D-03V70	B20
10,150	16,240	0.20	0.42	2245D-03V32	B31
10,150	16,240	0.25	0.53	2380N-04V00	B52
10,150	16,240	0.25	0.53	2380N-04V02	B52
10,150	16,240	0.25	0.53	2380N-04V04	B52
10,150	16,240	0.25	0.53	2380N-04V71	B52
10,870	17,400	0.17	0.38	2244N-025V00	B26
10,875	17,400	0.17	0.30	2240D-025V34	B10
15,000	23,200	0.40	0.85	2X90N-06V14	B112
N/A	8,000	2.00	2.71	2440N-32V10	B89
N/A	10,000	2.00	3.35	2640N-32V80	B99
N/A	13,050	1.00	1.46	2440N-16V37	B87
N/A	13,050	1.00	1.46	2440N-16V71	B87
N/A	14,500	0.81	1.19	2440N-12V37	B85
N/A	14,500	0.81	1.19	2440N-12V71	B85
N/A	15,080	0.50	0.91	2X90N-08V14	B113
N/A	18,560	0.25	0.53	2X90N-04V14	B109
N/A	20,290	0.75	1.30	2640N-12V32	B97
N/A	20,290	0.75	1.30	2640N-12V71	B97
N/A	20,300	0.40	0.77	2440N-06V91	B82
N/A	20,400	0.50	0.88	2440N-08V37	B83
N/A	20,400	0.50	0.88	2440N-08V71	B83
N/A	21,750	0.32	0.61	2440D-05V37	B80
N/A	23,780	0.25	0.50	2440N-04V37	B77
N/A	23,780	0.25	0.50	2440N-04V71	B77
N/A	26,090	0.50	0.97	2640N-08V32	B95
N/A	26,100	0.20	0.45	2440D-03V37	B73
N/A	31,900	0.16	0.37	2440D-025V37	B71
N/A	36,000	0.50	*	2840D-08V30	B108
N/A	36,230	0.20	0.51	2640D-03V32	B93
N/A	36,230	0.32	0.67	2740D-05V32	B105
N/A	40,580	0.32	0.76	2840D-05V32	B107
N/A	40,600	0.16	0.45	2640D-025V32	B91
N/A	40,600	0.20	0.52	2740D-03V30	B103
N/A	48,000	0.20	0.57	2840D-03V34	B106
N/A	60,000*	0.20	1.57	2840D-03V34*	B106

## Hose Selection Chart







By Inside Diameter						
I.D. inch	I.D. mm	Working Pressure 2.5:1	Working Pressure 4:1	O.D. inch	Hose Number	Page No.
0.08	3	9,280	5,800	0.20	2020N-02V30	B4
0.08	2	11,020	6,890	0.20	2020N-012V30	B3
0.12	4	15,950	9,970	0.28	2240D-02V32	B9
0.16	4	31,900	N/A	0.37	2440D-025V37	B71
0.16	4	40,600	N/A	0.45	2640D-025V32	B91
0.16	4	45,000	N/A	0.48	2740D-025V30	B101
0.17	4	16,240	10,150	0.36	2243D-025V70	B19
0.17	5	17,400	10,875	0.30	2240D-025V34	B10
0.17	5	17,400	10,870	0.38	2244N-025V00	B26
0.20	5	16,230	10,145	0.38	2240D-03V34	B13
0.20	5	16,240	10,150	0.42	2243D-03V70	B20
0.20	5	16,240	10,150	0.42	2245D-03V32	B31
0.20	5	26,100	N/A	0.45	2440D-03V37	B73
0.20	5	36,230	N/A	0.51	2640D-03V32	B93
0.20	5	40,600	N/A	0.52	2740D-03V30	B103
0.20	5	48,000	N/A	0.57	2840D-03V34	B106
0.20	6	60,000*	N/A	1.57	2840D-03V34*	B106
0.25	6	7,192	4,495	0.47	2040N-04V00	B6
0.25	6	10,440	6,525	0.50	2245N-04V00	B33
0.25	6	10,440	6,525	0.50	2245N-04V02	B33
0.25	6	10,440	6,525	0.50	2245N-04V04	B33
0.25	6	12,000	7,500	0.52	2390N-04V10	B60
0.25	6	12,000	7,500	0.52	2390N-04V12	B60
0.25	6	12,000	7,500	0.52	2390N-04V16	B60
0.25	6	13,200	8,250	0.50	2380N-04V33	B55
0.25	6	14,000	8,750	0.50	2243D-04V70	B23
0.25	6	14,490	9,050	0.45	2240D-04V32	B15
0.25	6	16,240	10,150	0.53	2380N-04V00	B52
0.25	6	16,240	10,150	0.53	2380N-04V02	B52
0.25	6	16,240	10,150	0.53	2380N-04V04	B52
0.25	6	16,240	10,150	0.53	2380N-04V71	B52
0.25	6	18,560	N/A	0.53	2X90N-04V14	B109
0.25	6	23,780	N/A	0.50	2440N-04V37	B77
0.25	6	23,780	N/A	0.50	2440N-04V71	B77
0.31	8	9,280	5,800	0.56	2245N-05V00	B37
0.32	8	8,700	5,437	0.56	2380F-05V07	B47
0.17	4	13,040	8,150	0.52	2240D-05V32	B18

**A**

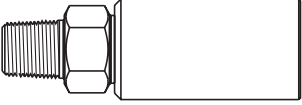
## Hose Selection Chart

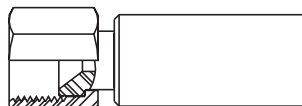
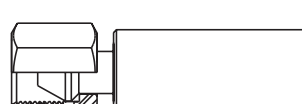
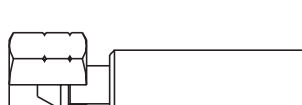
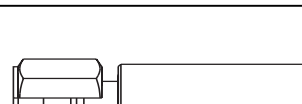



By Inside Diameter						
I.D. inch	I.D. mm	Working Pressure 2.5:1	Working Pressure 4:1	O.D. inch	Hose Number	Page No.
0.32	8	13,600	8,500	0.62	2380N-05V00	B58
0.32	8	13,600	8,500	0.62	2380N-05V71	B58
0.32	8	21,750	N/A	0.61	2440D-05V37	B80
0.32	8	36,230	N/A	0.67	2740D-05V32	B105
0.32	8	40,580	N/A	0.76	2840D-05V32	B107
0.40	10	8,700	5,440	0.67	2245N-06V00	B39
0.40	10	10,300	6,450	0.70	2390N-06V13	B63
0.40	10	23,200	15,000	0.85	2X90N-06V14	B112
0.40	10	20,300	N/A	0.77	2440N-06V91	B82
0.50	13	7,540	4,710	0.81	2380F-08V07	B48
0.50	13	8,120	5,075	0.81	2245N-08V30	B41
0.50	13	10,400	6,500	0.81	2390N-08V12	B65
0.50	13	10,400	6,500	0.81	2390N-08V13	B65
0.50	13	10,400	6,500	0.81	2390N-08V16	B65
0.50	13	12,760	7,970	0.89	2244N-08V10	B28
0.50	13	12,760	7,970	0.89	2244N-08V71	B28
0.50	13	15,080	N/A	0.91	2X90N-08V14	B113
0.50	13	20,400	N/A	0.88	2440N-08V37	B83
0.50	13	20,400	N/A	0.88	2440N-08V71	B83
0.50	13	26,090	N/A	0.97	2640N-08V32	B95
0.50	13	36,000	N/A	*	2840D-08V30	B108
0.75	20	6,960	4,350	1.13	2245N-12V30	B43
0.75	20	20,290	N/A	1.30	2640N-12V32	B97
0.75	20	20,290	N/A	1.30	2640N-12V71	B97
0.76	20	6,380	3,987	1.12	2380F-12V07	B50
0.81	20	8,100	5,575	1.14	2390N-12V03	B67
0.81	20	14,500	N/A	1.19	2440N-12V37	B85
0.81	20	14,500	N/A	1.19	2440N-12V71	B85
1.00	25	6,380	3,990	1.34	2245N-16V30	B45
1.00	25	6,500	4,100	1.37	2390N-16V12	B69
1.00	25	6,500	4,100	1.37	2390N-16V13	B69
1.00	25	6,500	4,100	1.37	2390N-16V16	B69
1.00	25	13,050	N/A	1.46	2440N-16V37	B87
1.00	25	13,050	N/A	1.46	2440N-16V71	B87
1.25	32	6,380	3,990	1.73	2244N-20V30	B30
2.00	50	N/A	5,000	2.71	2440N-32V10	B89
2.00	50	10,000	N/A	3.35	2640N-32V80	B99

## Hose Fitting Chart

Fitting	Fitting Description	Fitting Designation
	National Pipe Tapered (NPT) Male Fitting	01
	National Pipe Tapered(NPT) Female Fitting	02
	JIC Female Swivel Fitting	06
	Type "M" Female Swivel Fitting	AY
	BSP Female Swivel Fitting	BC or 92
	Metric Female Swivel Fitting	C3 or C9
	BSP Male Fitting	D9 or 3B
	Male Stecko Fitting	MB
	Tube Stub Fitting	TU

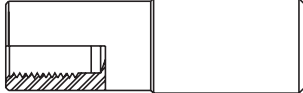
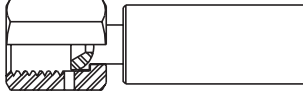
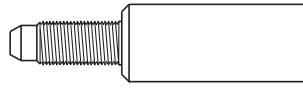
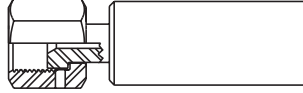
**A**

## Hose Fitting Chart

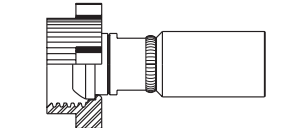

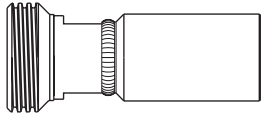
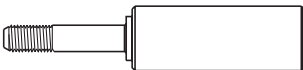
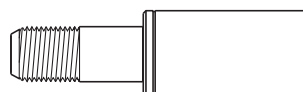

Fitting	Fitting Description	Fitting Designation
	Male Waterblast Nozzle	ZE or 3Z
	Female Waterblast Nozzle	EZ
	Medium Pressure Female Swivel	5Y
	Nozzle Nipple	YH
	High Pressure Female Swivel	6Y
	Right Hand Male for Water Blast Nozzle Fitting	call <b>polyflex</b> for update
	Right Hand Female for Water Blast Nozzle Fitting	EY
	Left Hand Female for Water Blast Nozzle Fitting	EY
	2" Hammer Union (Male) Cone with Wing Nut End Fitting	HE

## Hose Fitting Chart

Fitting	Fitting Description	Fitting Designation
	2" Hammer Union (Female) Cone Threaded End with Seal	HN
	High Pressure Tube Nipple	Y4 or YM
	Medium Pressure Tube Nipple	Y2

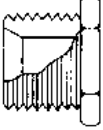
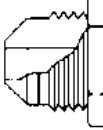
**A**

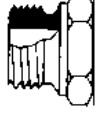
## Hose Fitting Guide

Parflex Style Number						
Dash Size	NPTF Pipe Thread Size	SAE (JIC) 37° Flare Thread Size	Metric Swivel Female Thread Size	Metric Swivel Female Thread Size	Male BSPP Thread Size	BSP Swivel Female Thread Size
2	1/8-27	5/16-24	—	—	—	—
3	—	3/8-24	—	—	—	—
4	1/4-18	7/16-20	—	—	1/4"	1/4"
5	—	1/2-20	—	—	—	—
6	3/8-18	9/16-18	M12 x 1.5	—	3/8"	3/8"
8	1/2-14	3/4-16	M14 x 1.5	M16 x 1.5	1/2"	1/2"
10	—	7/8-14	M16 x 1.5	M18 x 1.5	—	5/8"
12	3/4-14	1 1/16-12	M18 x 1.5	M20 x 1.5	3/4"	3/4"
—	—	—	—	—	—	—
14	—	1 3/16-12	—	M22 x 1.5	—	—
15	—	—	M22 x 1.5	—	—	—
16	1-11 1/2	1 5/16-12	—	M24 x 1.5	1 "	1 "
18	—	—	—	—	—	—
20	1 1/4-11 1/2	1 5/8-12	M26 x 1.5	—	—	—
22	—	—	—	M30 x 2	—	—
24	1 1/2-11 1/2	1 7/8-12	—	—	—	—
25	—	—	M30 x 2	—	—	—
—	—	—	—	M36 x 2	—	—
28	—	—	—	—	—	—
30	—	—	M36 x 2	—	—	—
32	2-11 1/2	2 1/2-12	—	M42 x 2	—	—
33	—	—	—	—	—	—



## Hose Part Numbering System

**A**

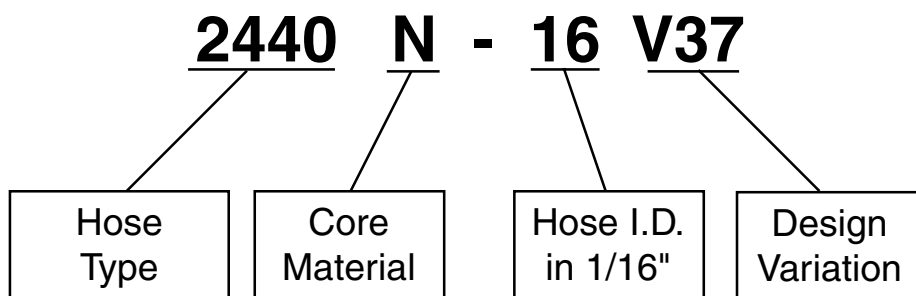
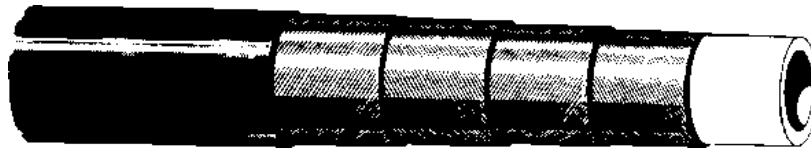



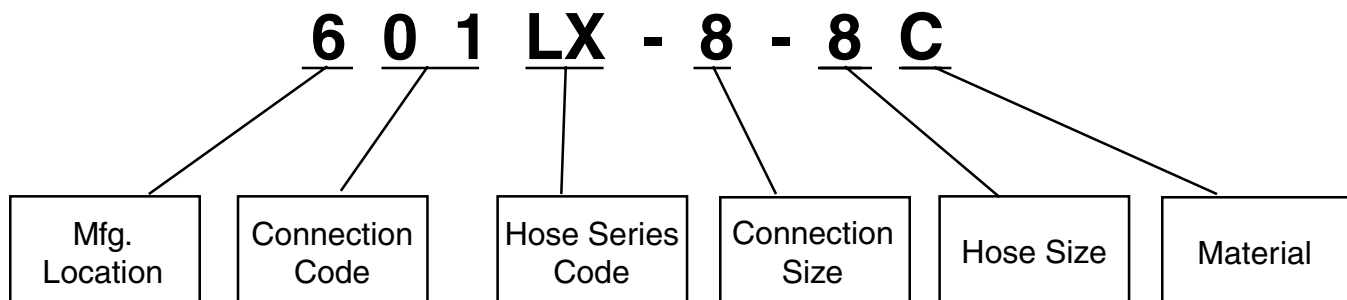
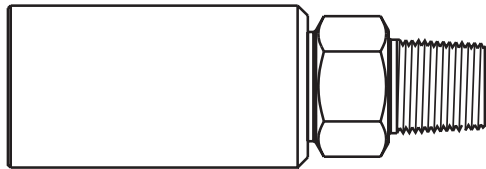







## Hose End Fitting Part Numbering System



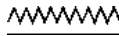

## Explanation of Symbols Used in Hose and Fitting Tables

**A**

Symbol	Definition	Symbol	Definition
#	Part Number		Thickness
	Hose I.D.		Weight
	Hose O.D.		Thread Size
	Working Pressure		Hex Size
	Minimum Burst Pressure		Diameter
	Minimum Bend Radius		Elongation



## Table of Contents –Section B

### 2000 Series

2020N-012 .....	B3
2020N-02 .....	B4
2040N-04 .....	B6

### 2200 Series

2240D-02 .....	B9
2240D-025 .....	B10
2240D-03 .....	B13
2240D-04 .....	B15
2240D-05 .....	B18
2243D-025 .....	B19
2243D-03 .....	B20
2243D-04 .....	B23
2244N-025 .....	B26
2244N-08 .....	B28
2244N-20 .....	B30
2245D-03 .....	B31
2245N-04 .....	B33
2245N-05 .....	B37
2245N-06 .....	B39
2245N-08 .....	B41
2245N-12 .....	B43
2245N-16 .....	B45

### 2300 Series

2380F-05 .....	B47
2380F-08 .....	B48
2380F-12 .....	B50
2380N-04 .....	B52
2380N-04 .....	B55
2380N-05 .....	B58
2390N-04 .....	B60
2390N-06 .....	B61
2390N-08 .....	B65
2390N-12 .....	B67
2390N-16 .....	B69

(Continued)

**B**

 Contact Parflex for current price and delivery information on shaded parts.

**Table of Contents –Section B (continued)**

**2400 Series**

2440D-025 .....	B71
2440D-03 .....	B73
2440N-04 .....	B77
2440D-05 .....	B80
2440N-06 .....	B82
2440N-08 .....	B83
2440N-12 .....	B85
2440N-16 .....	B87
2440N-32 .....	B89

**2600 Series**

2640D-025 .....	B91
2640D-03 .....	B93
2640N-08 .....	B95
2640N-12 .....	B97
2640N-32 .....	B99

**2700 Series**

2740D-025 .....	B101
2740D-03 .....	B103
2740D-05 .....	B105

**2800 Series**

2840D-03 .....	B106
2840D-05 .....	B107
2840D-08 .....	B108

**2X00 Series**

2X90N-04 .....	B109
2X90N-06 .....	B110
2X90N-08 .....	B111

**57CR Series**

57CR .....	B112
------------	------

**HP Series**

HP/HP8 .....	B113
--------------	------

**Twin Lines**

2445N-04 .....	B116
2380N-04 .....	B119

<b>Bundles</b> .....	B123
----------------------	------

## 2020N-012 **polyflex** Hose

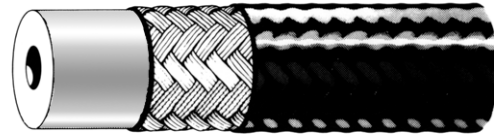

**B**

Part Number	Jacket Color	Minimum I.D.		Maximum O.D.		Maximum Working Pressure with 2.5:1 Safety Factor		Maximum Working Pressure with 4:1 Safety Factor		Minimum Burst Pressure		Minimum Bend Radius		Weight	
		inch	mm	inch	mm	psi	MPa	psi	MPa	psi	MPa	inch	mm	lbs/ft	kg/m
#															
2020N-012V30	Black	0.08	2	0.20	5	11,020	76.0	6,890	47.5	27,550	190.0	0.79	20	0.035	0.05

**Construction:** Polyamide core tube, high tensile synthetic fiber reinforced and a polyamide outer cover.

**Temperature Range:** -40°F and +140°F (-40°C and +60°C). Contact **polyflex** for temperatures outside this range.

**Typical Applications:** Small diameter, extremely flexible hose. Replaces steel tubing in instrumentation, diagnostic, hydraulic workholding, and testing applications.

## National Pipe Tapered (NPT) Male Fitting 01

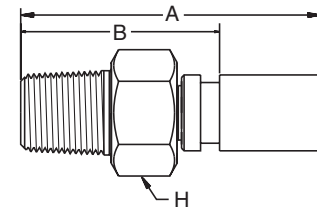

Part Number	Connection Type Thread Size	A Overall Length		B Cutoff Allowance		H Hex Size		Maximum Working Pressure	
		inch	mm	inch	mm	inch	mm	psi	MPa
#									
601EX-2-012	1/8" NPT	1.37	35	0.93	24	0.44	11	11,020	76.0
601EX-4-012	1/4" NPT	1.48	38	1.03	26	0.63	16	11,020	76.0

## JIC Female Swivel Fitting 06

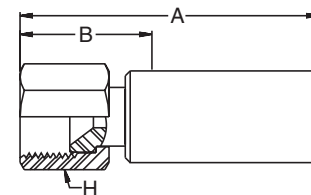

Part Number	Connection Type Thread Size	A Overall Length		B Cutoff Allowance		H Hex Size		Maximum Working Pressure	
		inch	mm	inch	mm	inch	mm	psi	MPa
#									
106EX-4-012	7/16" - 20	1.24	31	0.79	20	0.59	15	10,000	69.0



## 2020N-02 **polyflex** Hose

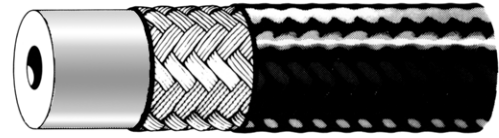

Part Number	Jacket Color	Minimum I.D.		Maximum O.D.		Maximum Working Pressure with 2.5:1 Safety Factor		Maximum Working Pressure with 4:1 Safety Factor		Minimum Burst Pressure		Minimum Bend Radius		Weight	
		inch	mm	inch	mm	psi	MPa	psi	MPa	psi	MPa	inch	mm	lbs/ft	kg/m
#															
2020N-02V30	Black	0.12	3	0.24	6	9,280	64.0	5,800	40.0	23,200	160.0	1.18	30	0.05	0.07

**Construction:** Polyamide core tube, high tensile synthetic fiber reinforced and a polyamide outer cover.

**Typical Applications:** Small diameter, extremely flexible hose. Replaces steel tubing in instrumentation, diagnostic mini-hydraulic systems, and testing applications.

**Temperature Range:** -40°F and +140°F (-40°C and +60°C). Contact **polyflex** for temperatures outside this range.

Available in bulk quantities with Field Attachable end fittings or as factory made and tested assemblies.

## National Pipe Tapered (NPT) Male Fitting

01

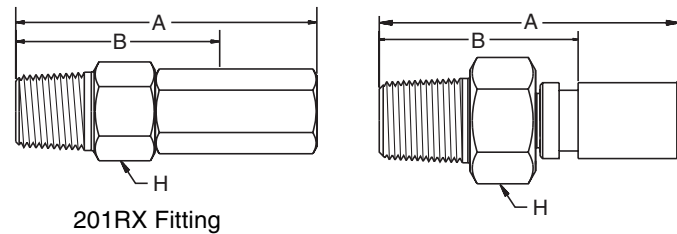

201RX Fitting

Part Number	Connection Type Thread Size	A Overall Length		B Cutoff Allowance		H Hex Size		Maximum Working Pressure	
		inch	mm	inch	mm	inch	mm	psi	MPa
#									
601EX-2-2	1/8" NPT	1.33	34	0.93	24	0.44	11	10,000	69.0
201RX-2-2C	1/8" NPT	1.54	39	1.10	28	0.44	11	10,000	69.0

## JIC Female Swivel Fitting

06

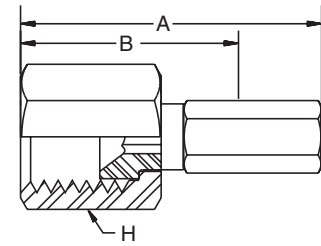

Part Number	Hose Size	Connection Type Thread Size	A Overall Length		B Cutoff Allowance		H Hex Size		Maximum Working Pressure	
			inch	mm	inch	mm	inch	mm	psi	MPa
#										
206RX-4-2C	0.12	7/16" - 20	1.56	40	1.10	28	0.56	14	10,000	69.0

**B**

## Tube Stub Fitting

TU

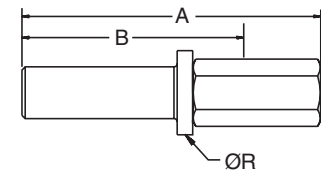

Part Number	Hose Size	Connection Type Thread Size	A Overall Length		B Cutoff Allowance		H Hex Size		Maximum Working Pressure	
			inch	mm	inch	mm	inch	mm	psi	MPa
#										
2TURX-4-2C	0.12	1/4" TUBE	1.65	42	1.20	30	0.38	10	10,000	69.0

## 2040N-04 **polyflex** Hose



Part Number	Jacket Color	Minimum I.D.		Maximum O.D.		Maximum Working Pressure with 2.5:1 Safety Factor		Maximum Working Pressure with 4:1 Safety Factor		Minimum Burst Pressure		Minimum Bend Radius		Weight	
		inch	mm	inch	mm	psi	MPa	psi	MPa	psi	MPa	inch	mm	lbs/ft	kg/m
#															
2040N-04V00	Black	0.25	6	0.47	12	7,192	49.6	4,495	31.0	17,980	124.0	1.58	40	0.11	0.16

**Construction:** Polyamide core tube, one braided layer of high tensile steel wire and a polyurethane outer cover.

**Temperature Range:** -40°F and +140°F (-40°C and +60°C). Contact **polyflex** for temperatures outside this range.

**Typical Applications:** For use with petroleum or synthetic hydraulic fluids and pressure testing equipment.

## National Pipe Tapered (NPT) Male Fitting 01

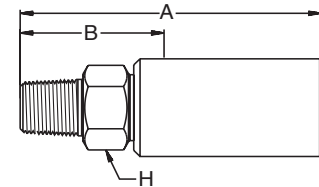

Part Number	Connection Type Thread Size	A Overall Length		B Cutoff Allowance		H Hex Size		Maximum Working Pressure	
		inch	mm	inch	mm	inch	mm	psi	MPa
#									
101PX-4-4	1/4" NPT	2.18	55	1.04	26	0.56	14	7,192	49.6
601NX-4-4C	1/4" NPT	2.38	60	1.12	28	0.63	16	7,192	49.6

## Type "M" Female Swivel Fitting AY

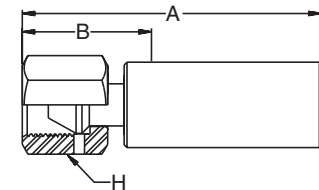

Part Number	Connection Type Thread Size	A Overall Length		B Cutoff Allowance		H Hex Size		Maximum Working Pressure	
		inch	mm	inch	mm	inch	mm	psi	MPa
#									
6AYNX-6-4C	9/16" - 18	2.36	60	1.11	28	0.68	17	7,192	49.6

## JIC Female Swivel Fitting

06

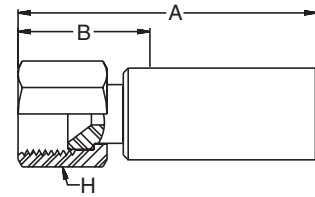

Part Number	Connection Type Thread Size	A Overall Length		B Cutoff Allowance		H Hex Size		Maximum Working Pressure	
		inch	mm	inch	mm	inch	mm	psi	MPa
#									
106NX-4-4	7/16" - 20	2.56	65	1.37	35	0.75	19	7,192	49.6
106NX-6-4	9/16" - 18	2.56	65	1.32	34	0.75	19	7,192	49.6
106PX-4-4	9/16" - 18	2.10	53	0.98	25	0.68	17	7,192	49.6
606NX-4-4C	7/16" - 20	2.23	57	0.99	25	0.63	16	7,192	49.6
606NX-6-4C	9/16" - 18	2.36	60	1.11	28	0.68	17	7,192	49.6

**B**

## BSP Female Swivel Fitting

BC

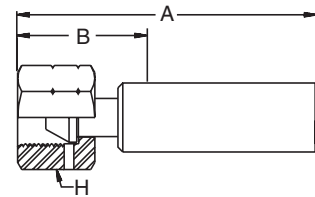

Part Number	Connection Type Thread Size	A Overall Length		B Cutoff Allowance		H Hex Size		Maximum Working Pressure	
		inch	mm	inch	mm	inch	mm	psi	MPa
#									
1BCPX-4-4	1/4" BSPP	2.00	51	0.88	22	0.66	17	7,192	49.6

## Metric Female Swivel Fitting

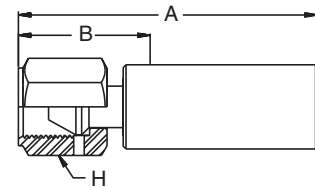

C3



Part Number	Connection Type Thread Size	A Overall Length		B Cutoff Allowance		H Hex Size		Maximum Working Pressure	
		inch	mm	inch	mm	inch	mm	psi	MPa
#									
1C3PX-8-4	M14 x 1.5	1.98	50	0.85	22	0.75	19	7,192	49.6

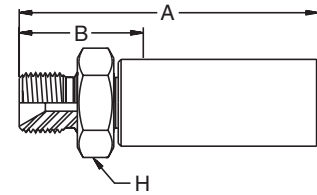

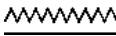
## BSP Male Fitting D9

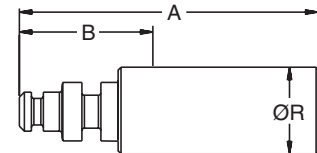

Part Number	Connection Type Thread Size	A Overall Length		B Cutoff Allowance		H Hex Size		Maximum Working Pressure	
		inch	mm	inch	mm	inch	mm	psi	MPa
#									
1D9PX-4-4	1/4" BSPP	2.26	57	1.23	31	0.75	19	7,192	49.6

## Male Stecko Fitting MB



Part Number	Connection Type Thread Size	A Overall Length		B Cutoff Allowance		R Diameter		Maximum Working Pressure	
		inch	mm	inch	mm	inch	mm	psi	MPa
#									
1MBPX-6-4	N/A	2.52	64	1.40	36	0.54	14	7,192	49.6

## 2240D-02 **polyflex** Hose

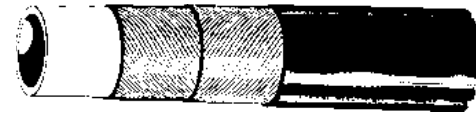

Part Number	Jacket Color	Minimum I.D.		Maximum O.D.		Maximum Working Pressure with 2.5:1 Safety Factor		Maximum Working Pressure with 4:1 Safety Factor		Minimum Burst Pressure		Minimum Bend Radius		Weight	
		inch	mm	inch	mm	psi	MPa	psi	MPa	psi	MPa	inch	mm	lbs/ft	kg/m
#															
2240D-02V32	Blue	0.12	3	0.28	7	15,950	110.0	9,969	68.8	39,875	275.0	2.36	60	0.047	0.07

**B**

**Construction:** Polyoxymethylene core tube, high strength wire reinforced and a polyamide cover.

**Temperature Range:** -40°F and +140°F (-40°C and +60°C). Contact for temperatures outside this range.

**Typical Applications:** Small diameter flexible hose, ideal for tight routing applications such as high pressure heat exchanger tube cleaning in petrochemical and power plants.

## National Pipe Tapered (NPT) Male Fitting

01

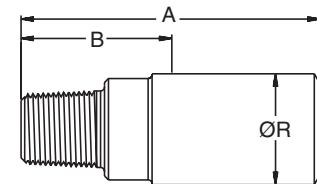

\*ProLance® fitting

Part Number	Connection Type Thread Size	A Overall Length		B Cutoff Allowance		R Diameter		Maximum Working Pressure	
		inch	mm	inch	mm	inch	mm	psi	MPa
#									
601PL-1-2 *	1/16" NPT	1.06	27	0.47	12	0.38	10	15,000	103.4

\*ProLance® fitting

## Female Water Blast Nozzle Fitting

EZ

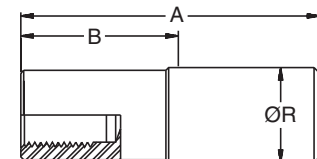

\*ProLance® fitting

Part Number	Connection Type Thread Size	A Overall Length		B Cutoff Allowance		R Diameter		Maximum Working Pressure	
		inch	mm	inch	mm	inch	mm	psi	MPa
#									
6HYPL-1-2 *	#12 - 28	1.13	29	0.53	13	0.38	10	15,000	103.4

\*ProLance® fitting

## 2240D-025 **polyflex** Hose



Part Number	Jacket Color	Minimum I.D.		Maximum O.D.		Maximum Working Pressure with 2.5:1 Safety Factor		Maximum Working Pressure with 4:1 Safety Factor		Minimum Burst Pressure		Minimum Bend Radius		Weight	
		inch	mm	inch	mm	psi	MPa	psi	MPa	psi	MPa	inch	mm	lbs/ft	kg/m
#															
2240D-025V34	Red	0.17	4	0.30	8	17,400	120.0	10,875	75.0	43,500	300.0	2.95	75	0.067	0.10

**Construction:** Polyoxymethylene core tube, high strength wire reinforced and a polyamide cover.

**Temperature Range:** -40°F and +140°F (-40°C and +60°C). Contact for temperatures outside this range.

**Typical Applications:** Small diameter flexible hose, ideal for tight routing applications such as high pressure heat exchanger tube cleaning in petrochemical and power plants.

## National Pipe Tapered (NPT) Male Fitting 01

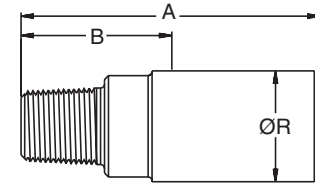

\*ProLance® fitting

Part Number	Connection Type Thread Size	A Overall Length		B Cutoff Allowance		R Diameter		Maximum Working Pressure	
		inch	mm	inch	mm	inch	mm	psi	MPa
#									
601AX-1-2A *	1/16" NPT	1.20	30	0.57	14	0.44	11	15,000	103.4
601AX-2-2A *	1/8" NPT	1.10	28	0.47	12	0.44	11	15,000	103.4

\*ProLance® fitting



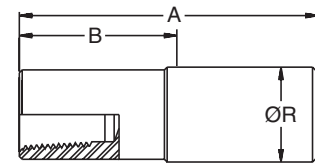

## National Pipe Tapered (NPT) Female Fitting

02



\*ProLance<sup>®</sup> fitting

Part Number	Connection Type Thread Size	A Overall Length		B Cutoff Allowance		R Diameter		Maximum Working Pressure	
		inch	mm	inch	mm	inch	mm	psi	MPa
#									
602AX-1-2A *	1/16" NPT	1.50	38	0.86	22	0.44	11	15,000	103.4



\*ProLance<sup>®</sup> fitting

**B**

## Type "M" Female Swivel Fitting

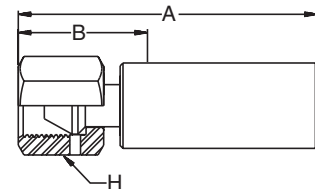
AY





Part Number	Connection Type Thread Size	A Overall Length		B Cutoff Allowance		H Hex Size		Maximum Working Pressure	
		inch	mm	inch	mm	inch	mm	psi	MPa
#									
6AYAX-6-2A	9/16" - 18	1.52	39	0.86	22	0.75	19	17,400	120.0

## JIC Female Swivel Fitting

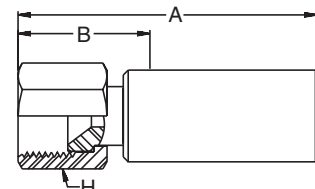
06



\*ProLance<sup>®</sup> fitting

Part Number	Connection Type Thread Size	A Overall Length		B Cutoff Allowance		H Hex Size		Maximum Working Pressure	
		inch	mm	inch	mm	inch	mm	psi	MPa
#									
606AX-4-2A *	7/16" - 20	1.53	39	0.88	22	0.63	16	10,000	69.0



\*ProLance<sup>®</sup> fitting

## Male Water Blast Nozzle Fitting

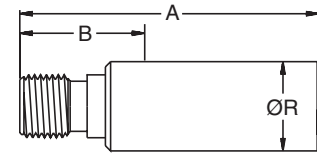
### 3Z and ZE

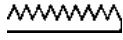

\*ProLance<sup>®</sup> fitting

Part Number	Connection Type Thread Size	A Overall Length		B Cutoff Allowance		R Diameter		Maximum Working Pressure	
		inch	mm	inch	mm	inch	mm	psi	MPa
#									
63ZAX-5-2A *	5/16" - 32	1.10	28	0.44	11	0.44	11	15,000	103.4
6ZEAX-5-2A *	5/16" - 24	1.31	33	0.69	18	0.44	11	15,000	103.4



\*ProLance<sup>®</sup> fitting

## Female Water Blast Nozzle Fitting

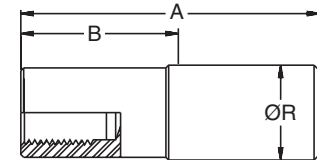
### EZ

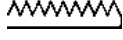

\*ProLance<sup>®</sup> fitting

Part Number	Connection Type Thread Size	A Overall Length		B Cutoff Allowance		R Diameter		Maximum Working Pressure	
		inch	mm	inch	mm	inch	mm	psi	MPa
#									
6EZAX-5-2A *	5/16" - 24	1.50	38	0.90	23	0.44	11	15,000	103.4
E204UZD1 *	#12 - 28	1.28	33	0.66	17	0.44	11	15,000	103.4

\*ProLance<sup>®</sup> fitting

## 2240D-03 **polyflex** Hose

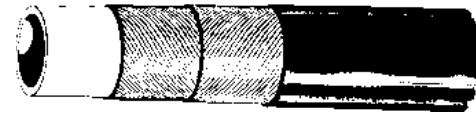

Part Number	Jacket Color	Minimum I.D.		Maximum O.D.		Maximum Working Pressure with 2.5:1 Safety Factor		Maximum Working Pressure with 4:1 Safety Factor		Minimum Burst Pressure		Minimum Bend Radius		Weight	
		inch	mm	inch	mm	psi	MPa	psi	MPa	psi	MPa	inch	mm	lbs/ft	kg/m
#															
2240D-03V34	Red	0.20	5	0.38	10	16,230	111.9	10,145	70.0	40,580	279.9	3.75	95	0.134	0.20

**B**

**Construction:** Polyoxymethylene core tube, high strength wire reinforced and a polyamide cover.

**Temperature Range:** -40°F and +140°F (-40°C and +60°C). Contact **polyflex** for temperatures outside this range.

**Typical Applications:** Small diameter flexible hose, ideal for tight routing applications such as high pressure heat exchanger tube cleaning in petrochemical and power plants.

## National Pipe Tapered (NPT) Male Fitting

01

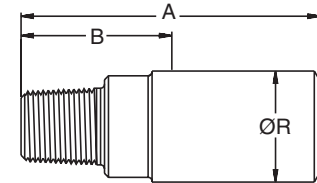
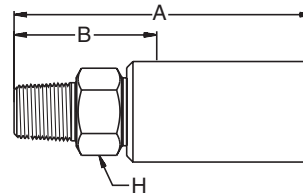

\*ProLance<sup>®</sup> fitting

Part Number	Connection Type Thread Size	A Overall Length		B Cutoff Allowance		H Hex Size/ R Diameter		Maximum Working Pressure	
		inch	mm	inch	mm	inch	mm	psi	MPa
#									
601AX-2-3 *	1/8" NPT	1.28	33	0.50	13	0.52	13	15,000	103.4
601LX-4-3	1/4" NPT	2.86	73	1.30	33	0.56	14	15,000	103.4

\*ProLance<sup>®</sup> fitting

## National Pipe Tapered (NPT) Female Fitting

02

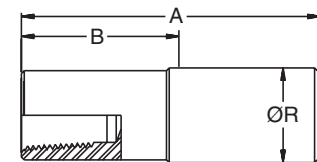

\*ProLance<sup>®</sup> fitting

Part Number	Connection Type Thread Size	A Overall Length		B Cutoff Allowance		R Diameter		Maximum Working Pressure	
		inch	mm	inch	mm	inch	mm	psi	MPa
#									
602AX-2-3 *	1/8" NPT	1.64	42	0.84	21	0.52	13	15,000	103.4

\*ProLance<sup>®</sup> fitting

## Type "M" Female Swivel Fitting AY

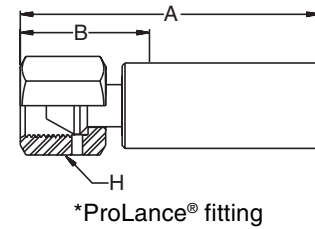

Part Number	Connection Type Thread Size	A Overall Length		B Cutoff Allowance		H Hex Size		Maximum Working Pressure	
		inch	mm	inch	mm	inch	mm	psi	MPa
#									
6AYAX-6-3 *	9/16" - 18	1.77	45	0.94	24	0.75	19	16,230	111.9
6AYLX-6-3	9/16" - 18	2.80	71	1.28	33	0.75	19	16,230	111.9

\*ProLance fitting

## JIC Female Swivel Fitting 06

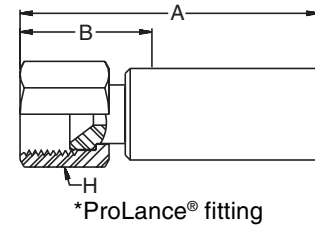

Part Number	Connection Type Thread Size	A Overall Length		B Cutoff Allowance		H Hex Size		Maximum Working Pressure	
		inch	mm	inch	mm	inch	mm	psi	MPa
#									
606AX-4-3C *	7/16" - 20	1.84	47	0.86	22	0.56	14	10,000	69.0

\*ProLance fitting

## Male Water Blast Nozzle Fitting 3Z

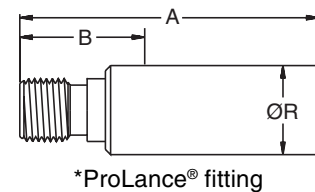

Part Number	Connection Type Thread Size	A Overall Length		B Cutoff Allowance		R Diameter		Maximum Working Pressure	
		inch	mm	inch	mm	inch	mm	psi	MPa
#									
63ZAX-5-3 *	5/16" - 32	1.31	33	0.50	13	0.52	13	15,000	103.4
63ZAX-5-3C	5/16" - 32	1.35	34	0.37	9	0.56	14	15,000	103.4

\*ProLance fitting

## 2240D-04 **polyflex** Hose

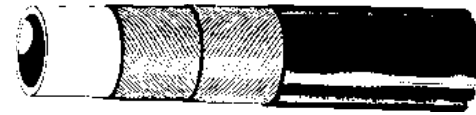

Part Number	Jacket Color	Minimum I.D.		Maximum O.D.		Maximum Working Pressure with 2.5:1 Safety Factor		Maximum Working Pressure with 4:1 Safety Factor		Minimum Burst Pressure		Minimum Bend Radius		Weight	
		inch	mm	inch	mm	psi	MPa	psi	MPa	psi	MPa	inch	mm	lbs/ft	kg/m
#															
2240D-04V32	Blue	0.25	6	0.45	11	14,490	99.9	9,050	62.4	36,230	249.9	4.33	110	0.175	0.26

**B**

**Construction:** Polyoxymethylene core tube, high strength wire reinforced and a polyamide cover.

**Temperature Range:** -40°F and +140°F (-40°C and +60°C). Contact **polyflex** for temperatures outside this range.

**Typical Applications:** Small diameter flexible hose, ideal for tight routing applications such as high pressure heat exchanger tube cleaning in petrochemical and power plants.

## National Pipe Tapered (NPT) Male Fitting

01

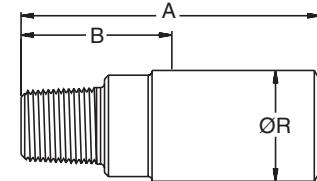
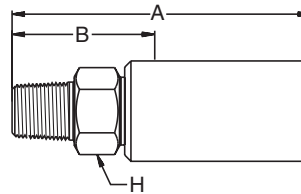

\*ProLance® fitting

Part Number	Connection Type Thread Size	A Overall Length		B Cutoff Allowance		H Hex Size/ R Diameter		Maximum Working Pressure	
		inch	mm	inch	mm	inch	mm	psi	MPa
#									
101NX-4-4	1/4" NPT	2.57	65	1.35	34	0.63	16	14,490	99.9
101NX-6-4	3/8" NPT	2.63	67	1.38	35	0.75	19	14,490	99.9
601NX-2-4 *	1/8" NPT	1.44	37	0.50	13	0.62	16	14,490	99.9
601NX-4-4 *	1/4" NPT	1.56	40	0.63	16	0.62	16	14,490	99.9
601NX-4-4C	1/4" NPT	2.38	60	1.12	28	0.63	16	14,490	99.9

\*ProLance® fitting

## National Pipe Tapered (NPT) Female Fitting

02

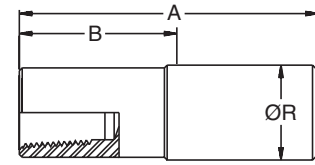

\*ProLance® fitting

Part Number	Connection Type Thread Size	A Overall Length		B Cutoff Allowance		R Diameter		Maximum Working Pressure	
		inch	mm	inch	mm	inch	mm	psi	MPa
#									
602NX-4-4 *	1/4" NPT	2.38	60	1.12	28	0.63	16	14,490	99.9

\*ProLance® fitting

## Type "M" Female Swivel Fitting

AY

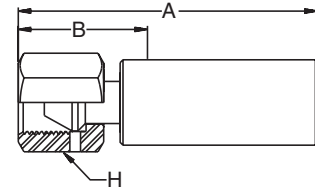

Part Number	Connection Type Thread Size	A Overall Length		B Cutoff Allowance		H Hex Size		Maximum Working Pressure	
		inch	mm	inch	mm	inch	mm	psi	MPa
#									
6AYNX-6-4	9/16" - 18	2.56	65	1.32	34	0.75	19	14,490	99.9
6AYNX-6-4C	9/16" - 18	2.36	60	1.11	28	0.68	17	14,490	99.9

## JIC Female Swivel Fitting

06

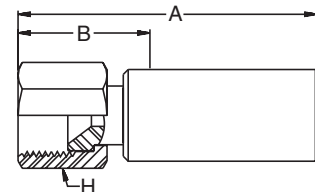

Part Number	Connection Type Thread Size	A Overall Length		B Cutoff Allowance		H Hex Size		Maximum Working Pressure	
		inch	mm	inch	mm	inch	mm	psi	MPa
#									
106NX-4-4	7/16" - 20	2.56	65	1.37	35	0.75	19	10,000	69.0
106NX-6-4	9/16" - 18	2.56	65	1.32	34	0.75	19	10,000	69.0
606NX-4-4C	7/16" - 20	2.23	57	0.99	25	0.63	16	10,000	69.0
606NX-6-4C	9/16" - 18	2.36	60	1.11	28	0.68	17	10,000	69.0

## BSP Female Swivel Fitting

BC

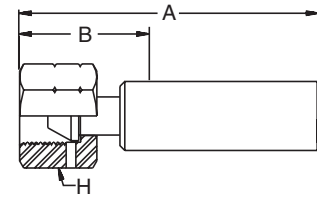

Part Number	Connection Type Thread Size	A Overall Length		B Cutoff Allowance		H Hex Size		Maximum Working Pressure	
		inch	mm	inch	mm	inch	mm	psi	MPa
#									
1BCNX-4-4	1/4" BSPP	2.50	64	1.25	32	0.75	19	14,490	99.9

**B**

## BSP Male Fitting

D9

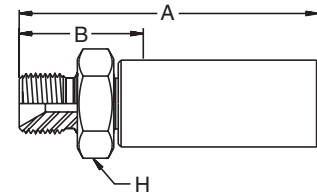

Part Number	Connection Type Thread Size	A Overall Length		B Cutoff Allowance		H Hex Size		Maximum Working Pressure	
		inch	mm	inch	mm	inch	mm	psi	MPa
#									
1D9NX-4-4	1/4" BSPP	2.64	67	1.40	36	0.75	19	14,490	99.9

## Male Water Blast Nozzle Fitting

3Z

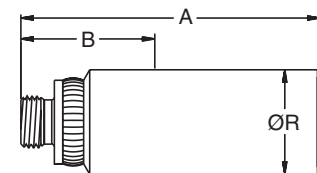

\*ProLance<sup>®</sup> fitting

Part Number	Connection Type Thread Size	A Overall Length		B Cutoff Allowance		R Diameter		Maximum Working Pressure	
		inch	mm	inch	mm	inch	mm	psi	MPa
#									
63ZNX-5-4C *	5/16" - 32	2.79	71	0.45	11	0.67	17	14,490	99.9

\*ProLance<sup>®</sup> fitting

## 2240D-05 **polyflex** Hose

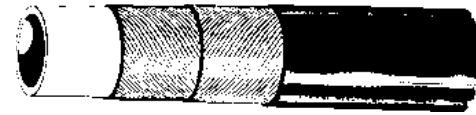

Part Number	Jacket Color	Minimum I.D.		Maximum O.D.		Maximum Working Pressure with 2.5:1 Safety Factor		Maximum Working Pressure with 4:1 Safety Factor		Minimum Burst Pressure		Minimum Bend Radius		Weight	
		inch	mm	inch	mm	psi	MPa	psi	MPa	psi	MPa	inch	mm	lbs/ft	kg/m
#															
2240D-05V32	Blue	0.32	8	0.52	13	13,040	89.9	8,150	56.2	32,610	224.9	4.72	120	0.17	0.26

**Construction:** Polyoxymethylene core tube, high strength wire reinforced and a polyamide cover.

**Temperature Range:** -40°F and +140°F (-40°C and +60°C). Contact **polyflex** for temperatures outside this range.

**Typical Applications:** High flow, flexible hose, ideal for high pressure heat exchanger tube cleaning in petrochemical and power plants.

## National Pipe Tapered (NPT) Male Fitting

01

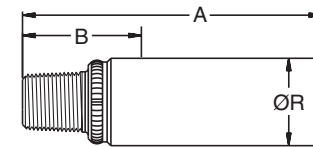

\*ProLance<sup>®</sup> fitting

Part Number	Connection Type Thread Size	A Overall Length		B Cutoff Allowance		H Hex Size/ R Diameter		Maximum Working Pressure	
		inch	mm	inch	mm	inch	mm	psi	MPa
#									
601AX-6-5 *	3/8" NPT	1.70	43	1.02	26	0.69	18	13,040	89.9

\*ProLance<sup>®</sup> fitting



## 2243D-025 **polyflex** Hose



Part Number	Jacket Color	Minimum I.D.		Maximum O.D.		Maximum Working Pressure with 2.5:1 Safety Factor		Maximum Working Pressure with 4:1 Safety Factor		Minimum Burst Pressure		Minimum Bend Radius		Weight	
		inch	mm	inch	mm	psi	MPa	psi	MPa	psi	MPa	inch	mm	lbs/ft	kg/m
#															
2243D-025V70	SS Braid	0.17	4	0.36	9	16,240	112.0	10,150	70.0	40,600	280.0	4.00	102	0.15	0.22

**B**

**Construction:** Polyoxymethylene core tube, high strength wire reinforced and a polyamide cover with a stainless steel outer braid.

**Temperature Range:** -40°F and +140°F (-40°C and +60°C). Contact **polyflex** for temperatures outside this range.

**Typical Applications:** Small diameter flexible hose, ideal for tight routing applications such as high pressure heat exchanger tube cleaning in petrochemical and power plants. Stainless steel outer braid improves abrasion and cut resistance.

## National Pipe Tapered (NPT) Male Fitting 01

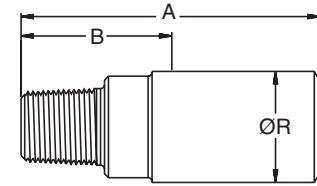

\*ProLance<sup>®</sup> fitting

Part Number	Connection Type Thread Size	A Overall Length		B Cutoff Allowance		R Diameter		Maximum Working Pressure	
		inch	mm	inch	mm	inch	mm	psi	MPa
#									
601VX-2-2A *	1/8" NPT	1.10	28	0.44	11	0.47	12	15,000	103.4

\*ProLance<sup>®</sup> fitting

## 2243D-03 **polyflex** Hose



Part Number	Jacket Color	Minimum I.D.		Maximum O.D.		Maximum Working Pressure with 2.5:1 Safety Factor		Maximum Working Pressure with 4:1 Safety Factor		Minimum Burst Pressure		Minimum Bend Radius		Weight	
		inch	mm	inch	mm	psi	MPa	psi	MPa	psi	MPa	inch	mm	lbs/ft	kg/m
#															
2243D-03V70	SS Braid	0.20	5	0.42	11	16,240	112.0	10,150	70.0	40,600	280.0	4.50	114	0.14	0.21

**Construction:** Polyoxymethylene core tube, high strength wire reinforced and a polyamide cover with a stainless steel outer braid.

**Temperature Range:** -40°F and +140°F (-40°C and +60°C). Contact **polyflex** for temperatures outside this range.

**Typical Applications:** Small diameter flexible hose, ideal for tight routing applications such as high pressure heat exchanger tube cleaning in petrochemical and power plants. Stainless steel outer braid improves abrasion and cut resistance.

## National Pipe Tapered (NPT) Male Fitting

01

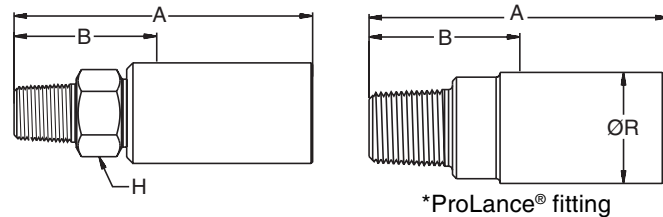

Part Number	Connection Type Thread Size	A Overall Length		B Cutoff Allowance		H Hex Size/ R Diameter		Maximum Working Pressure	
		inch	mm	inch	mm	inch	mm	psi	MPa
#									
601AX-2-3 *	1/8" NPT	1.28	33	0.50	13	0.52	13	15,000	103.4
601LX-4-3	1/4" NPT	2.86	73	1.30	33	0.56	14	15,000	103.4

\*ProLance® fitting

## National Pipe Tapered (NPT) Female Fitting

02

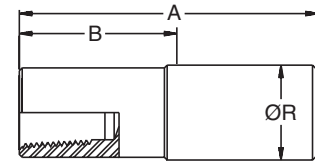

\*ProLance® fitting

Part Number	Connection Type Thread Size	A Overall Length		B Cutoff Allowance		R Diameter		Maximum Working Pressure	
		inch	mm	inch	mm	inch	mm	psi	MPa
#									
602AX-2-3 *	1/8" NPT	1.64	42	0.84	21	0.52	13	15,000	103.4

\*ProLance® fitting



**B**

## Type "M" Female Swivel Fitting

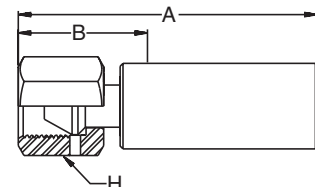
AY

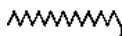

\*ProLance® fitting

Part Number	Connection Type Thread Size	A Overall Length		B Cutoff Allowance		H Hex Size		Maximum Working Pressure	
		inch	mm	inch	mm	inch	mm	psi	MPa
#									
6AYAX-6-3 *	9/16" - 18	1.77	45	0.94	24	0.75	19	16,240	112.0
6AYLX-6-3	9/16" - 18	2.80	71	1.28	33	0.75	19	16,240	112.0

\*ProLance® fitting

## JIC Female Swivel Fitting

06

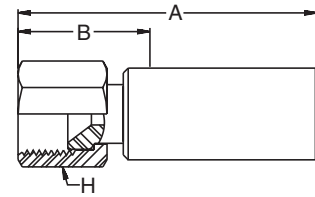

Part Number	Connection Type Thread Size	A Overall Length		B Cutoff Allowance		H Hex Size		Maximum Working Pressure	
		inch	mm	inch	mm	inch	mm	psi	MPa
#									
606AX-4-3C *	7/16" - 20	1.84	47	0.86	22	0.56	14	10,000	69.0



\*ProLance<sup>®</sup> fitting

## Male Water Blast Nozzle Fitting

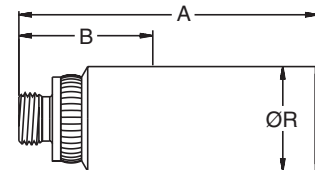
3Z

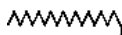

\*ProLance<sup>®</sup> fitting

Part Number	Connection Type Thread Size	A Overall Length		B Cutoff Allowance		R Diameter		Maximum Working Pressure	
		inch	mm	inch	mm	inch	mm	psi	MPa
#									
63ZAX-5-3 *	5/16" - 32	1.31	33	0.50	13	0.52	13	15,000	103.4
63ZAX-5-3C	5/16" - 32	1.35	34	0.37	9	0.56	14	15,000	103.4

\*ProLance<sup>®</sup> fitting

## 2243D-04 **polyflex** Hose



Part Number	Jacket Color	Minimum I.D.		Maximum O.D.		Maximum Working Pressure with 2.5:1 Safety Factor		Maximum Working Pressure with 4:1 Safety Factor		Minimum Burst Pressure		Minimum Bend Radius		Weight	
		inch	mm	inch	mm	psi	MPa	psi	MPa	psi	MPa	inch	mm	lbs/ft	kg/m
#															
2243D-04V70	SS Braid	0.25	6	0.50	13	14,000	96.6	8,750	60.3	35,000	241.4	5.00	127	0.20	0.30

**B**

**Construction:** Polyoxymethylene core tube, high strength wire reinforced and a polyamide cover with a stainless steel outer braid.

**Temperature Range:** -40°F and +140°F (-40°C and +60°C). Contact **polyflex** for temperatures outside this range.

**Typical Applications:** Small diameter flexible hose, ideal for tight routing applications such as high pressure heat exchanger tube cleaning in petrochemical and power plants. Stainless steel outer braid improves abrasion and cut resistance.

## National Pipe Tapered (NPT) Male Fitting

01

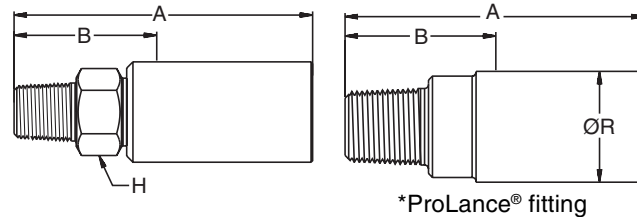

Part Number	Connection Type Thread Size	A Overall Length		B Cutoff Allowance		H Hex Size/ R Diameter		Maximum Working Pressure	
		inch	mm	inch	mm	inch	mm	psi	MPa
#									
101NX-4-4	1/4" NPT	2.57	65	1.35	34	0.63	16	10,000	69.0
101NX-6-4	3/8" NPT	2.63	67	1.38	35	0.75	19	10,000	69.0
601NX-2-4 *	1/8" NPT	1.44	37	0.50	13	0.62	16	10,000	69.0
601NX-4-4 *	1/4" NPT	1.56	40	0.63	16	0.62	16	10,000	69.0
601NX-4-4C	1/4" NPT	2.38	60	1.12	28	0.63	16	10,000	69.0



\*ProLance® fitting

## National Pipe Tapered (NPT) Female Fitting

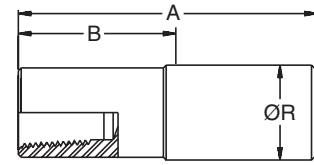
02



\*ProLance<sup>®</sup> fitting



Part Number	Connection Type Thread Size	A Overall Length		B Cutoff Allowance		R Diameter		Maximum Working Pressure	
		inch	mm	inch	mm	inch	mm	psi	MPa
#									
602NX-4-4 *	1/4" NPT	1.89	48	0.95	24	0.75	19	10,000	69.0

\*ProLance<sup>®</sup> fitting

## Type "M" Female Swivel Fitting

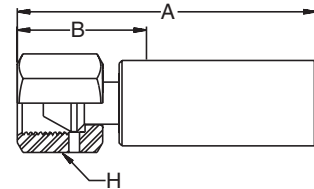
AY





Part Number	Connection Type Thread Size	A Overall Length		B Cutoff Allowance		H Hex Size		Maximum Working Pressure	
		inch	mm	inch	mm	inch	mm	psi	MPa
#									
6AYNX-6-4C	9/16" - 18	2.36	60	1.11	28	0.68	17	14,000	96.6
6AYNX-6-4	9/16" - 18	2.56	65	1.32	34	0.75	19	14,000	96.6

## JIC Female Swivel Fitting

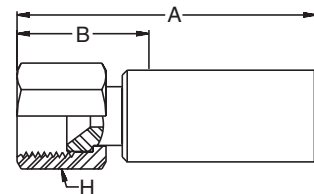
06





Part Number	Connection Type Thread Size	A Overall Length		B Cutoff Allowance		H Hex Size		Maximum Working Pressure	
		inch	mm	inch	mm	inch	mm	psi	MPa
#									
106NX-4-4	7/16" - 20	2.56	65	1.37	35	0.75	19	10,000	69.0
106NX-6-4	9/16" - 18	2.56	65	1.32	34	0.75	19	10,000	69.0
606NX-4-4C	7/16" - 20	2.23	57	0.99	25	0.63	16	10,000	69.0
606NX-6-4C	9/16" - 18	2.36	60	1.11	28	0.68	17	10,000	69.0

## BSP Female Swivel Fitting

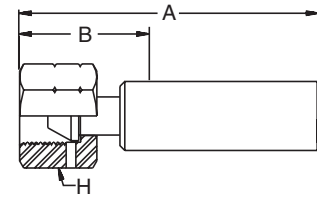
BC







Part Number	Connection Type Thread Size	A Overall Length		B Cutoff Allowance		H Hex Size		Maximum Working Pressure	
		inch	mm	inch	mm	inch	mm	psi	MPa
#									
1BCLX-4-4	1/4" BSPP	2.50	64	1.25	32	0.75	19	14,000	96.6

**B**

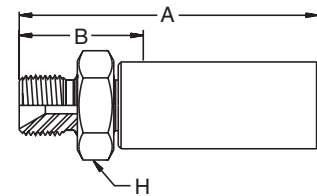
## BSP Male Fitting

D9





Part Number	Connection Type Thread Size	A Overall Length		B Cutoff Allowance		H Hex Size		Maximum Working Pressure	
		inch	mm	inch	mm	inch	mm	psi	MPa
#									
1D9LX-4-4	1/4" BSPP	2.64	67	1.40	36	0.75	19	14,000	96.6

## Male Water Blast Nozzle Fitting

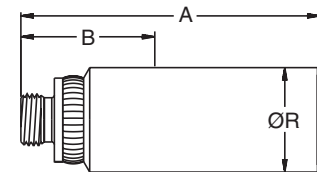
3Z



Part Number	Connection Type Thread Size	A Overall Length		B Cutoff Allowance		R Diameter		Maximum Working Pressure	
		inch	mm	inch	mm	inch	mm	psi	MPa
#									
63ZNX-5-4C	5/16" - 32	2.79	71	0.45	11	0.67	17	14,000	96.6

## 2244N-025 **polyflex** Hose



Part Number	Jacket Color	Minimum I.D.		Maximum O.D.		Maximum Working Pressure with 2.5:1 Safety Factor		Maximum Working Pressure with 4:1 Safety Factor		Minimum Burst Pressure		Minimum Bend Radius		Weight	
		inch	mm	inch	mm	psi	MPa	psi	MPa	psi	MPa	inch	mm	lbs/ft	kg/m
#															
2244N-025V00	Black	0.17	4	0.38	10	17,400	120.0	10,870	75.0	43,500	300.0	2.17	55	0.13	0.19

**Construction:** Polyamide core tube, high strength wire reinforced and a polyurethane outer cover.

**Temperature Range:** -40°F and +140°F (-40°C and +60°C). Contact **polyflex** for temperatures outside this range.

**Typical Applications:** Small diameter, low volumetric expansion hose. Ideal for pressure testing, portable hydraulic tools that require extreme kink resistance and maximum flexibility. Available in long single lengths and in Twin-Line construction.

## National Pipe Tapered (NPT) Male Fitting

01

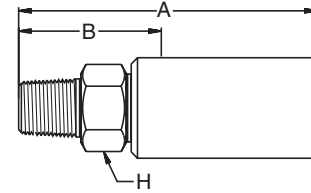



Part Number	Connection Type Thread Size	A Overall Length		B Cutoff Allowance		H Hex Size		Maximum Working Pressure	
		inch	mm	inch	mm	inch	mm	psi	MPa
#									
6018X-2-2A	1/8" NPT	1.86	47	0.76	19	0.63	16	15,000	103.4
6018X-2-2AC	1/8" NPT	2.18	55	1.80	46	0.50	13	15,000	103.4
6018X-4-2AC	1/4" NPT	2.44	62	1.35	34	0.62	16	15,000	103.4

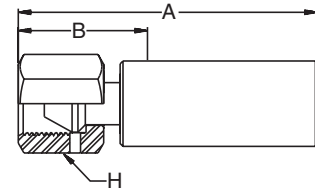

## Type "M" Female Swivel Fitting AY





Part Number	Connection Type Thread Size	A Overall Length		B Cutoff Allowance		H Hex Size		Maximum Working Pressure	
		inch	mm	inch	mm	inch	mm	psi	MPa
#									
1AY8X-6-2A	9/16" - 18	2.19	56	1.12	28	0.75	19	10,870	75.0
6AY8X-6-2AC	9/16" - 18	2.32	59	1.24	31	0.68	17	17,400	120.0

**B**

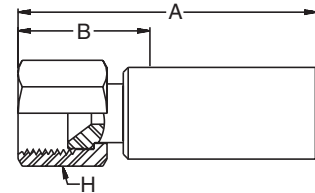
## JIC Female Swivel Fitting 06

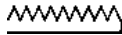

Part Number	Connection Type Thread Size	A Overall Length		B Cutoff Allowance		H Hex Size		Maximum Working Pressure	
		inch	mm	inch	mm	inch	mm	psi	MPa
#									
6068X-4-2AC	7/16" - 20	2.17	55	1.05	27	0.56	14	10,000	69.0

## 2244N-08 **polyflex** Hose



Part Number	Jacket Color	Minimum I.D.		Maximum O.D.		Maximum Working Pressure with 2.5:1 Safety Factor		Maximum Working Pressure with 4:1 Safety Factor		Minimum Burst Pressure		Minimum Bend Radius		Weight	
		inch	mm	inch	mm	psi	MPa	psi	MPa	psi	MPa	inch	mm	lbs/ft	kg/m
#															
2244N-08V10	Black	0.50	13	0.89	23	12,760	88.0	7,970	55.0	31,900	220.0	5.90	150	0.54	0.80
2244N-08V71	Black	0.50	13	0.89	23	12,760	88.0	7,970	55.0	31,900	220.0	5.90	150	0.54	0.80

**Construction:** Polyamide core tube, high strength wire reinforced and a polyurethane outer cover.

**Temperature Range:** -40°F and +140°F (-40°C and +60°C). Contact **polyflex** for temperatures outside this range.

**Typical Applications:** Flexible, lightweight, chemical resistant alternative to steel pipe and rubber hose for applications such as waterblasting, gas transfer, chemical injection, wireline logging services, and pressure testing. The -08V71 is typically used in Methanol injection applications.

## National Pipe Tapered (NPT) Male Fitting 01

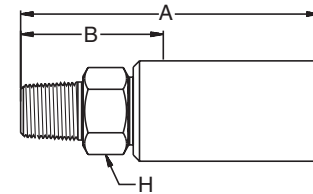

Part Number	Connection Type Thread Size	A Overall Length		B Cutoff Allowance		H Hex Size		Maximum Working Pressure	
		inch	mm	inch	mm	inch	mm	psi	MPa
#									
6018X-8-8C	1/2" NPT	3.46	88	1.67	42	1.00	25	12,760	88.0
601LX-8-8	1/2" NPT	3.75	95	1.68	43	1.25	32	12,760	88.0

## Type "M" Female Swivel Fitting AY

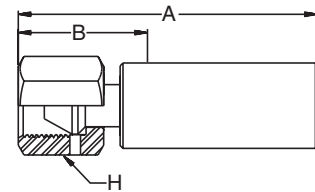

Part Number	Connection Type Thread Size	A Overall Length		B Cutoff Allowance		H Hex Size		Maximum Working Pressure	
		inch	mm	inch	mm	inch	mm	psi	MPa
#									
6AY8X-11-8C	1" - 12	3.27	83	1.49	38	1.25	32	12,760	88.0
6AYLX-11-8C	1" - 12	3.53	90	1.50	38	1.25	32	12,760	88.0
6AYLX-11-8C-SD *	1" - 12	3.53	90	1.50	38	1.25	32	12,760	88.0

\*SD – Corrosion resistant (sea water)

**B**

## JIC Female Swivel Fitting 06

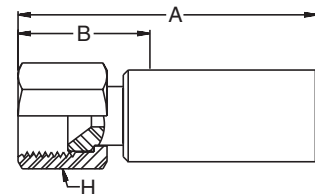

Part Number	Connection Type Thread Size	A Overall Length		B Cutoff Allowance		H Hex Size		Maximum Working Pressure	
		inch	mm	inch	mm	inch	mm	psi	MPa
#									
6068X-8-8C	3/4" - 16	3.10	79	1.30	33	0.87	22	10,000	69.0

## Metric Female Swivel Fitting C9

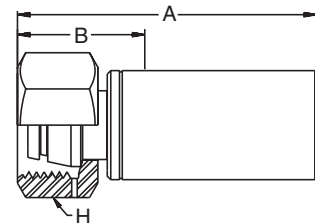

Part Number	Connection Type Thread Size	A Overall Length		B Cutoff Allowance		H Hex Size		Maximum Working Pressure	
		inch	mm	inch	mm	inch	mm	psi	MPa
#									
6C9LX-16-8C	M24 x 1.5	3.48	88	1.44	37	1.26	32	20,000	137.9

## 2244N-20 **polyflex** Hose

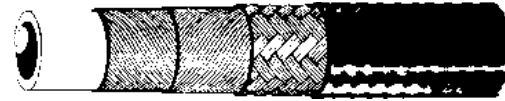

Part Number	Jacket Color	Minimum I.D.		Maximum O.D.		Maximum Working Pressure with 2.5:1 Safety Factor		Maximum Working Pressure with 4:1 Safety Factor		Minimum Burst Pressure		Minimum Bend Radius		Weight	
		inch	mm	inch	mm	psi	MPa	psi	MPa	psi	MPa	inch	mm	lbs/ft	kg/m
#															
2244N-20V30	Black	1.25	32	1.73	44	6,380	44.0	3,990	27.5	15,950	110.0	15.75	400	1.23	1.83

**Construction:** Polyamide core tube, high strength wire reinforced and a polyamide outer cover.

**Temperature Range:** -40°F and +140°F (-40°C and +60°C). Contact **polyflex** for temperatures outside this range.

**Typical Applications:** Lightweight, chemical resistant hose used to replace steel pipe and rubber hose for hydraulic test systems using Skydrol fluids and gas transfer services.

## JIC Female Swivel Fitting

06

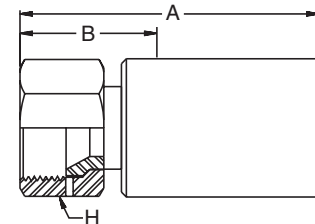

Part Number	Connection Type Thread Size	A Overall Length		B Cutoff Allowance		H Hex Size		Maximum Working Pressure	
		inch	mm	inch	mm	inch	mm	psi	MPa
#									
106NX-20-20	1-5/8" - 12	4.10	104	1.73	44	1.97	50	6,380	44.0

## 2245D-03 **polyflex** Hose

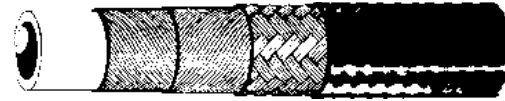

Part Number	Jacket Color	Minimum I.D.		Maximum O.D.		Maximum Working Pressure with 2.5:1 Safety Factor		Maximum Working Pressure with 4:1 Safety Factor		Minimum Burst Pressure		Minimum Bend Radius		Weight	
		inch	mm	inch	mm	psi	MPa	psi	MPa	psi	MPa	inch	mm	lbs/ft	kg/m
#															
2245D-03V32	Blue	0.20	5	0.42	11	16,240	112.0	10,150	70.0	40,600	280.0	3.50	89	0.13	0.19

**B**

**Construction:** Polyoxymethylene core tube, high strength wire reinforced and a polyamide outer cover.

**Temperature Range:** -40°F and +140°F (-40°C and +60°C). Contact **polyflex** for temperatures outside this range.

**Typical Applications:** Small diameter flexible hose, ideal for tight routing applications such as high pressure heat exchanger tube cleaning in petrochemical and power plants.

## National Pipe Tapered (NPT) Male Fitting

01

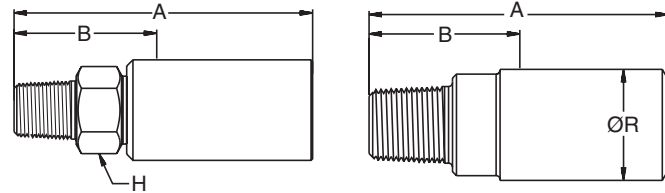

\*ProLance<sup>®</sup> fitting

Part Number	Connection Type Thread Size	A Overall Length		B Cutoff Allowance		H Hex Size/ R Diameter		Maximum Working Pressure	
		inch	mm	inch	mm	inch	mm	psi	MPa
#									
601AX-2-3 *	1/8" NPT	1.28	33	0.50	13	0.52	13	15,000	103.4
601LX-4-3	1/4" NPT	2.86	73	1.30	33	0.56	14	15,000	103.4

\*ProLance<sup>®</sup> fitting

## National Pipe Tapered (NPT) Female Fitting

02

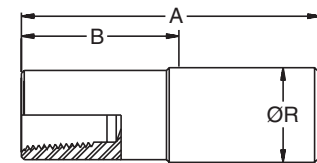

\*ProLance<sup>®</sup> fitting

Part Number	Connection Type Thread Size	A Overall Length		B Cutoff Allowance		R Diameter		Maximum Working Pressure	
		inch	mm	inch	mm	inch	mm	psi	MPa
#									
602AX-2-3 *	1/8" NPT	1.64	42	0.84	21	0.52	13	15,000	103.4

\*ProLance<sup>®</sup> fitting

## Type "M" Female Swivel Fitting AY

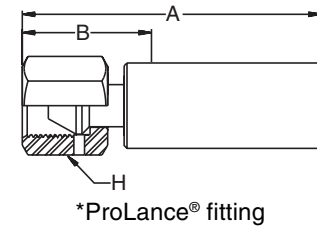

Part Number	Connection Type Thread Size	A Overall Length		B Cutoff Allowance		H Hex Size		Maximum Working Pressure	
		inch	mm	inch	mm	inch	mm	psi	MPa
#									
6AYAX-6-3 *	9/16" - 18	1.77	45	0.94	24	0.75	19	16,240	112.0
6AYLX-6-3	9/16" - 18	2.80	71	1.28	33	0.75	19	16,240	112.0

\*ProLance® fitting

## JIC Female Swivel Fitting 06

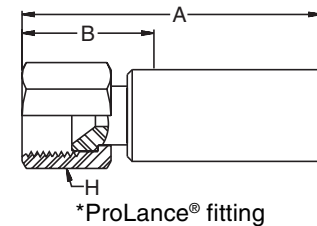

Part Number	Connection Type Thread Size	A Overall Length		B Cutoff Allowance		H Hex Size		Maximum Working Pressure	
		inch	mm	inch	mm	inch	mm	psi	MPa
#									
606AX-4-3C *	7/16" - 20	1.84	47	0.86	22	0.56	14	10,000	69.0

\*ProLance® fitting

## Male Water Blast Nozzle Fitting 3Z

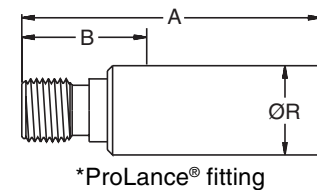

Part Number	Connection Type Thread Size	A Overall Length		B Cutoff Allowance		R Diameter		Maximum Working Pressure	
		inch	mm	inch	mm	inch	mm	psi	MPa
#									
63ZAX-5-3 *	5/16" - 32	1.31	33	0.50	13	0.52	13	15,000	103.4
63ZAX-5-3C	5/16" - 32	1.35	34	0.37	9	0.56	14	15,000	103.4

\*ProLance® fitting

## 2245N-04 **polyflex** Hose



Part Number	Jacket Color	Minimum I.D.		Maximum O.D.		Maximum Working Pressure with 2.5:1 Safety Factor		Maximum Working Pressure with 4:1 Safety Factor		Minimum Burst Pressure		Minimum Bend Radius		Weight	
		inch	mm	inch	mm	psi	MPa	psi	MPa	psi	MPa	inch	mm	lbs/ft	kg/m
#															
2245N-04V00	Black	0.25	6	0.50	13	10,440	72.0	6,525	45.0	26,100	180.0	2.76	70	0.17	0.25
2245N-04V02	Blue	0.25	6	0.50	13	10,440	72.0	6,525	45.0	26,100	180.0	2.76	70	0.17	0.25
2245N-04V04	Red	0.25	6	0.50	13	10,440	72.0	6,525	45.0	26,100	180.0	2.76	70	0.17	0.25

**B**

**Construction:** Polyamide core tube, high strength wire reinforced and a polyurethane outer cover.

**Temperature Range:** -40°F and +140°F (-40°C and +60°C). Contact **polyflex** for temperatures outside this range.

**Typical Applications:** Small diameter, low volumetric expansion hose. Ideal for pressure testing, portable hydraulic tools and hydraulic controls.

## National Pipe Tapered (NPT) Male Fitting

01

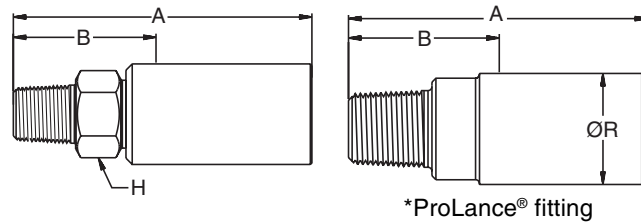

Part Number	Connection Type Thread Size	A Overall Length		B Cutoff Allowance		H Hex Size/ R Diameter		Maximum Working Pressure	
		inch	mm	inch	mm	inch	mm	psi	MPa
#									
101NX-4-4	1/4" NPT	2.57	65	1.35	34	0.63	16	10,400	71.7
101NX-6-4	3/8" NPT	2.63	67	1.38	35	0.75	19	10,400	71.7
601NX-2-4 *	1/8" NPT	1.44	37	0.50	13	0.62	16	10,400	71.7
601NX-4-4 *	1/4" NPT	1.56	40	0.63	16	0.62	16	10,400	71.7
601NX-4-4C	1/4" NPT	2.38	60	1.12	28	0.63	16	10,400	71.7



\*ProLance® fitting

## National Pipe Tapered (NPT) Female Fitting

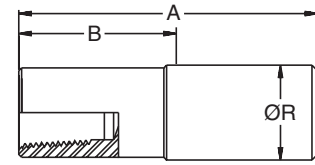
02



\*ProLance<sup>®</sup> fitting



Part Number	Connection Type Thread Size	A Overall Length		B Cutoff Allowance		R Diameter		Maximum Working Pressure	
		inch	mm	inch	mm	inch	mm	psi	MPa
#									
602NX-4-4 *	1/4" NPT	1.89	48	0.95	24	0.75	19	10,000	69.0

\*ProLance<sup>®</sup> fitting

## Type "M" Female Swivel Fitting

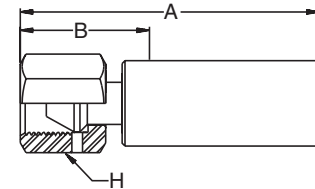
AY

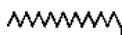



Part Number	Connection Type Thread Size	A Overall Length		B Cutoff Allowance		H Hex Size		Maximum Working Pressure	
		inch	mm	inch	mm	inch	mm	psi	MPa
#									
6AYNX-6-4	9/16" - 18	2.56	65	1.32	34	0.75	19	10,440	72.0
6AYNX-6-4C	9/16" - 18	2.36	60	1.11	28	0.68	17	10,440	72.0

## JIC Female Swivel Fitting

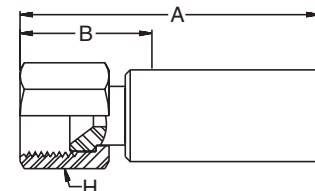
06

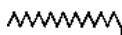





Part Number	Connection Type Thread Size	A Overall Length		B Cutoff Allowance		H Hex Size		Maximum Working Pressure	
		inch	mm	inch	mm	inch	mm	psi	MPa
#									
106NX-4-4	7/16" - 20	2.56	65	1.37	35	0.75	19	10,000	69.0
106NX-6-4	9/16" - 18	2.56	65	1.32	34	0.75	19	10,000	69.0
606NX-4-4C	7/16" - 20	2.23	57	0.99	25	0.63	16	10,000	69.0
606NX-6-4C	9/16" - 18	2.36	60	1.11	28	0.68	17	10,000	69.0

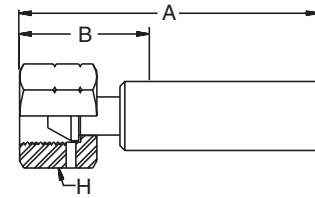

## BSP Female Swivel Fitting

BC







Part Number	Connection Type Thread Size	A Overall Length		B Cutoff Allowance		H Hex Size		Maximum Working Pressure	
		inch	mm	inch	mm	inch	mm	psi	MPa
#									
1BCNX-4-4	1/4" BSPP	2.50	64	1.25	32	0.75	19	10,440	72.0

**B**

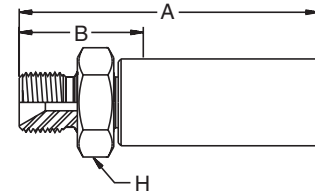
## BSP Male Fitting

D9





Part Number	Connection Type Thread Size	A Overall Length		B Cutoff Allowance		H Hex Size		Maximum Working Pressure	
		inch	mm	inch	mm	inch	mm	psi	MPa
#									
1D9NX-4-4	1/4" BSPP	2.64	67	1.40	36	0.75	19	10,440	72.0

## Metric Female Swivel Fitting

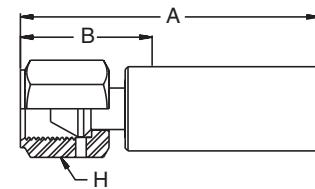
C3



Part Number	Connection Type Thread Size	A Overall Length		B Cutoff Allowance		H Hex Size		Maximum Working Pressure	
		inch	mm	inch	mm	inch	mm	psi	MPa
#									
1C3NX-8-4	M14 x 1.5	2.45	62	1.20	30	0.75	19	10,440	72.0

# Male Water Blast Nozzle Fitting

## 3Z

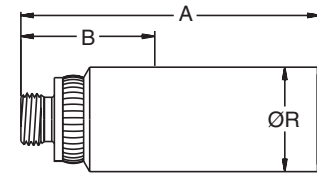

\*ProLance<sup>®</sup> fitting

Part Number	Connection Type Thread Size	A Overall Length		B Cutoff Allowance		R Diameter		Maximum Working Pressure	
		inch	mm	inch	mm	inch	mm	psi	MPa
#									
63ZNX-5-4C *	5/16" - 32	2.79	71	0.45	11	0.67	17	10,440	72.0

\*ProLance<sup>®</sup> fitting

## 2245N-05 **polyflex** Hose



Part Number	Jacket Color	Minimum I.D.		Maximum O.D.		Maximum Working Pressure with 2.5:1 Safety Factor		Maximum Working Pressure with 4:1 Safety Factor		Minimum Burst Pressure		Minimum Bend Radius		Weight	
		inch	mm	inch	mm	psi	MPa	psi	MPa	psi	MPa	inch	mm	lbs/ft	kg/m
#															
2245N-05V00	Black	0.31	8	0.56	14	9,280	64.0	5,800	40.0	23,200	160.0	3.94	100	0.22	0.33

**B**

**Construction:** Polyamide core tube, high strength wire reinforced and a polyurethane outer cover.

**Temperature Range:** -40°F and +140°F (-40°C and +60°C). Contact **polyflex** for temperatures outside this range.

**Typical Applications:** Low volumetric expansion hose for use with petroleum or synthetic hydraulic fluids, and in long lengths for waterblasting, pipe cleaning and line moleing applications.

## National Pipe Tapered (NPT) Male Fitting

01

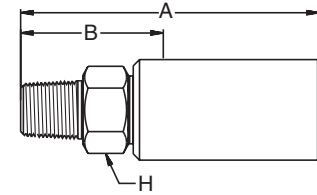

Part Number	Connection Type Thread Size	A Overall Length		B Cutoff Allowance		H Hex Size		Maximum Working Pressure	
		inch	mm	inch	mm	inch	mm	psi	MPa
#									
101NX-6-05	3/8" NPT	2.52	64	1.18	30	0.75	19	9,280	64.0

## JIC Female Swivel Fitting

06

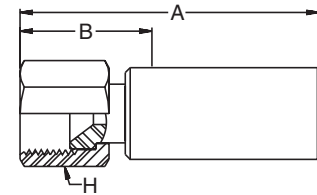



Part Number	Connection Type Thread Size	A Overall Length		B Cutoff Allowance		H Hex Size		Maximum Working Pressure	
		inch	mm	inch	mm	inch	mm	psi	MPa
#									
106NX-6-05	9/16" - 18	2.38	60	1.03	26	0.75	19	9,280	64.0

## BSP Female Swivel Fitting

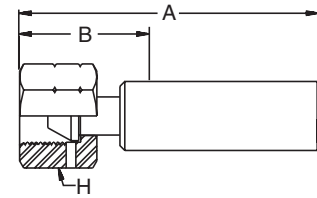
92





Part Number	Connection Type Thread Size	A Overall Length		B Cutoff Allowance		H Hex Size		Maximum Working Pressure	
		inch	mm	inch	mm	inch	mm	psi	MPa
#									
192NX-6-05	3/8" BSPP	2.50	64	1.21	31	0.87	22	9,280	64.0

## BSP Male Fitting

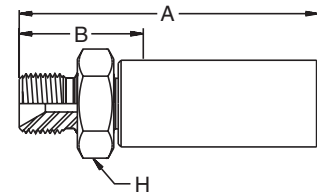
3B

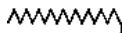



Part Number	Connection Type Thread Size	A Overall Length		B Cutoff Allowance		H Hex Size		Maximum Working Pressure	
		inch	mm	inch	mm	inch	mm	psi	MPa
#									
13BNX-6-05	3/8" BSPP	2.50	64	1.16	29	0.87	22	9,280	64.0

## Metric Female Swivel Fitting

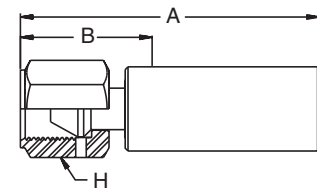
C9



Part Number	Connection Type Thread Size	A Overall Length		B Cutoff Allowance		H Hex Size		Maximum Working Pressure	
		inch	mm	inch	mm	inch	mm	psi	MPa
#									
1C9NX-12-05	M20 x 1.5	2.48	63	1.14	29	0.95	24	9,280	64.0

## 2245N-06 **polyflex** Hose



Part Number	Jacket Color	Minimum I.D.		Maximum O.D.		Maximum Working Pressure with 2.5:1 Safety Factor		Maximum Working Pressure with 4:1 Safety Factor		Minimum Burst Pressure		Minimum Bend Radius		Weight	
		inch	mm	inch	mm	psi	MPa	psi	MPa	psi	MPa	inch	mm	lbs/ft	kg/m
#															
2245N-06V30	Black	0.40	10	0.67	17	8,700	60.0	5,440	37.5	21,750	150.0	4.73	120	0.28	0.42

**B**

**Construction:** Polyamide core tube, high strength wire reinforced and a polyurethane outer cover.

**Temperature Range:** -40°F and +140°F (-40°C and +60°C). Contact **polyflex** for temperatures outside this range.

**Typical Applications:** Low volumetric expansion hose for use with petroleum or synthetic hydraulic fluids, and in long lengths for waterblasting, pipe cleaning and line moleing applications.

## National Pipe Tapered (NPT) Male Fitting

01

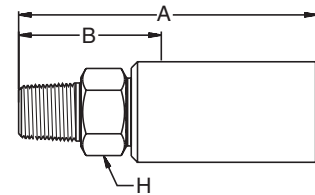

Part Number	Connection Type Thread Size	A Overall Length		B Cutoff Allowance		H Hex Size		Maximum Working Pressure	
		inch	mm	inch	mm	inch	mm	psi	MPa
#									
101NX-6-06	3/8" NPT	2.79	71	1.20	30	0.87	22	8,700	60.0
101NX-8-06	1/2" NPT	3.00	76	1.40	36	0.95	24	8,700	60.0

## JIC Female Swivel Fitting

06

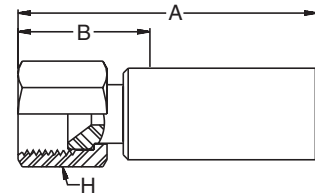



Part Number	Connection Type Thread Size	A Overall Length		B Cutoff Allowance		H Hex Size		Maximum Working Pressure	
		inch	mm	inch	mm	inch	mm	psi	MPa
#									
106NX-6-06	9/16" - 18	2.68	68	1.09	28	0.87	22	8,700	60.0
106NX-8-06	3/4" - 16	2.82	72	1.23	31	0.95	24	8,700	60.0

## BSP Female Swivel Fitting

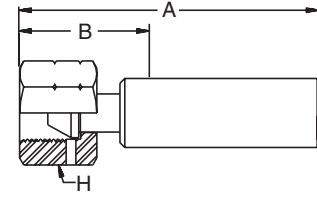
92

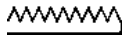



Part Number	Connection Type Thread Size	A Overall Length		B Cutoff Allowance		H Hex Size		Maximum Working Pressure	
		inch	mm	inch	mm	inch	mm	psi	MPa
#									
192NX-6-06	3/8" BSPP	2.70	69	1.11	28	0.87	22	8,700	60.0
192NX-8-06	1/2" BSPP	2.86	73	1.27	32	1.06	27	8,700	60.0

## BSP Male Fitting

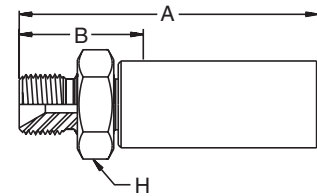
3B

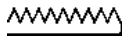



Part Number	Connection Type Thread Size	A Overall Length		B Cutoff Allowance		H Hex Size		Maximum Working Pressure	
		inch	mm	inch	mm	inch	mm	psi	MPa
#									
13BNX-6-06	3/8" BSPP	2.78	71	1.18	30	0.87	22	8,700	60.0
13BNX-8-06	1/2" BSPP	2.97	75	1.38	35	0.87	22	8,700	60.0

## Metric Female Swivel Fitting

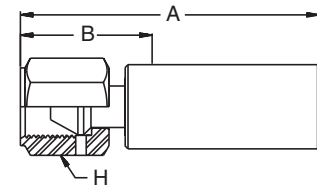
C9

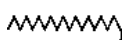

Part Number	Connection Type Thread Size	A Overall Length		B Cutoff Allowance		H Hex Size		Maximum Working Pressure	
		inch	mm	inch	mm	inch	mm	psi	MPa
#									
1C9NX-14-06	M22 x 1.5	2.78	71	0.93	24	1.062	27	8,700	60.0

## 2245N-08 **polyflex** Hose



Part Number	Jacket Color	Minimum I.D.		Maximum O.D.		Maximum Working Pressure with 2.5:1 Safety Factor		Maximum Working Pressure with 4:1 Safety Factor		Minimum Burst Pressure		Minimum Bend Radius		Weight	
		inch	mm	inch	mm	psi	MPa	psi	MPa	psi	MPa	inch	mm	lbs/ft	kg/m
#															
2245N-08V30	Black	0.50	13	0.81	21	8,120	56.0	5,075	35.0	20,300	140.0	5.50	140	0.35	0.52

**B**

**Construction:** Polyamide core tube, high strength wire reinforced and a polyamide outer cover.

**Temperature Range:** -40°F and +140°F (-40°C and +60°C). Contact **polyflex** for temperatures outside this range.

**Typical Applications:** Lightweight, chemical resistant hose used to replace steel pipe and rubber hose for hydraulic test systems using Skydrol®\* fluids and gas transfer services.

## National Pipe Tapered (NPT) Male Fitting

01

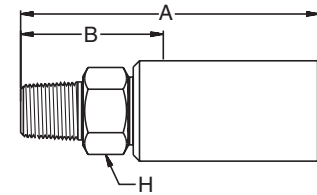



Part Number	Connection Type Thread Size	A Overall Length		B Cutoff Allowance		H Hex Size		Maximum Working Pressure	
		inch	mm	inch	mm	inch	mm	psi	MPa
#									
6019X-8-8C	1/2" NPT	3.37	86	1.68	43	1.00	25	8,120	56.0
6019X-8-8	1/2" NPT	3.35	85	1.43	36	0.87	22	8,120	56.0

\*Skydrol® is a registered trademark of Solutia, Inc.

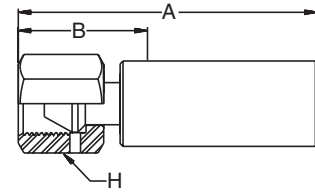
## Type "M" Female Swivel Fitting AY



Part Number	Connection Type Thread Size	A Overall Length		B Cutoff Allowance		H Hex Size		Maximum Working Pressure	
		inch	mm	inch	mm	inch	mm	psi	MPa
#									
6AY9X-11-8C	1" - 12	3.20	81	1.50	38	1.25	32	8,120	56.0

## JIC Female Swivel Fitting 06

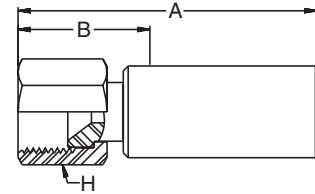

Part Number	Connection Type Thread Size	A Overall Length		B Cutoff Allowance		H Hex Size		Maximum Working Pressure	
		inch	mm	inch	mm	inch	mm	psi	MPa
#									
6069X-8-8C	3/4" - 16	3.00	76	1.30	33	0.87	22	8,120	56.0



## 2245N-12 **polyflex** Hose



Part Number	Jacket Color	Minimum I.D.		Maximum O.D.		Maximum Working Pressure with 2.5:1 Safety Factor		Maximum Working Pressure with 4:1 Safety Factor		Minimum Burst Pressure		Minimum Bend Radius		Weight	
		inch	mm	inch	mm	psi	MPa	psi	MPa	psi	MPa	inch	mm	lbs/ft	kg/m
#															
2245N-12V30	Black	0.75	19	1.13	29	6,960	48.0	4,350	30.0	17,400	120.0	9.45	240	0.62	0.92

**B**

**Construction:** Polyamide core tube, high strength wire reinforced and a polyamide outer cover.

**Temperature Range:** -40°F and +140°F (-40°C and +60°C). Contact **polyflex** for temperatures outside this range.

**Typical Applications:** Lightweight, chemical resistant hose used to replace steel pipe and rubber hose for hydraulic test systems using synthetic and phosphate ester fluids, such as Skydrol®\* fluids and gas transfer service.

## National Pipe Tapered (NPT) Male Fitting 01

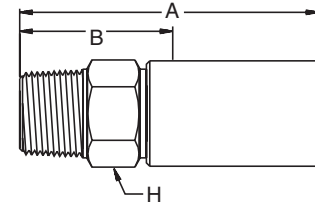



Part Number	Connection Type Thread Size	A Overall Length		B Cutoff Allowance		H Hex Size		Maximum Working Pressure	
		inch	mm	inch	mm	inch	mm	psi	MPa
#									
6019X-12-12	3/4" NPT	3.88	99	1.58	40	1.07	27	6,960	48.0
1019X-16-12	1" NPT	4.10	104	1.78	45	1.42	36	6,960	48.0

Contact Technical Services for specific application information.

\*Skydrol® is a registered trademark of Solutia, Inc.

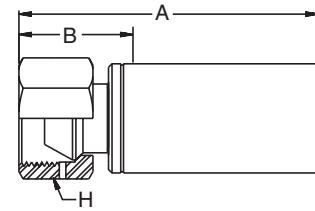

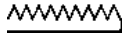
## Type "M" Female Swivel Fitting AY

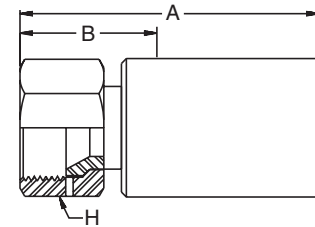

Part Number	Connection Type Thread Size	A Overall Length		B Cutoff Allowance		H Hex Size		Maximum Working Pressure	
		inch	mm	inch	mm	inch	mm	psi	MPa
#									
6AYLX-16-12C	1-5/16" - 12	4.15	105	1.52	39	1.50	38	6,960	48.0

## JIC Female Swivel Fitting 06



Part Number	Connection Type Thread Size	A Overall Length		B Cutoff Allowance		H Hex Size		Maximum Working Pressure	
		inch	mm	inch	mm	inch	mm	psi	MPa
#									
1069X-12-12	1-1/16" - 12	4.00	102	1.69	43	1.42	36	6,960	48.0
1069X-16-12	1-5/16" - 12	3.93	100	1.57	40	1.62	41	6,960	48.0
606LX-16-12C	1-5/16" - 12	4.29	109	1.68	43	1.50	38	6,960	48.0

## 2245N-16 **polyflex** Hose



Part Number	Jacket Color	Minimum I.D.		Maximum O.D.		Maximum Working Pressure with 2.5:1 Safety Factor		Maximum Working Pressure with 4:1 Safety Factor		Minimum Burst Pressure		Minimum Bend Radius		Weight	
		inch	mm	inch	mm	psi	MPa	psi	MPa	psi	MPa	inch	mm	lbs/ft	kg/m
#															
2245N-16V30	Black	1.00	25	1.34	34	6,380	44.0	3,990	27.5	15,950	110.0	11.02	280	0.78	1.16

**B**

**Construction:** Polyamide core tube, high strength wire reinforced and a polyamide outer cover.

**Temperature Range:** -40°F and +140°F (-40°C and +60°C). Contact **polyflex** for temperatures outside this range.

**Typical Applications:** Lightweight, chemical resistant hose used to replace steel pipe and rubber hose for hydraulic test systems using synthetic and phosphate ester fluids, such as Skydrol®\* fluids and gas transfer service.

## National Pipe Tapered (NPT) Male Fitting 01

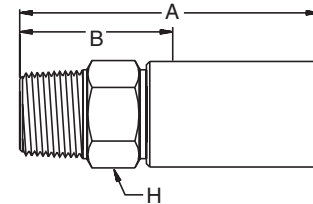





Part Number	Connection Type Thread Size	A Overall Length		B Cutoff Allowance		H Hex Size		Maximum Working Pressure	
		inch	mm	inch	mm	inch	mm	psi	MPa
#									
1019X-16-16	1" NPT	4.10	104	1.78	45	1.42	36	6,380	44.0
6019X-16-16C	1" NPT	4.38	111	2.25	57	1.38	35	6,380	44.0

Contact Technical Services for specific application information.

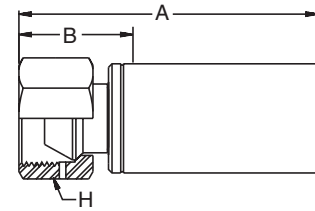
\*Skydrol® is a registered trademark of Solutia, Inc.



## Type "M" Female Swivel Fitting AY

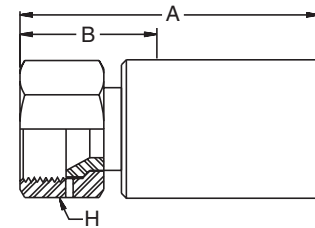

Part Number	Connection Type Thread Size	A Overall Length		B Cutoff Allowance		H Hex Size		Maximum Working Pressure	
		inch	mm	inch	mm	inch	mm	psi	MPa
#									
6AY9X-16-16C	1-5/16" - 12	3.79	96	1.65	42	1.50	38	6,380	44.0

## JIC Female Swivel Fitting 06



Part Number	Connection Type Thread Size	A Overall Length		B Cutoff Allowance		H Hex Size		Maximum Working Pressure	
		inch	mm	inch	mm	inch	mm	psi	MPa
#									
6069X-16-16C	1-5/16" - 12	3.79	96	1.65	42	1.50	38	6,380	44.0
1069X-16-16	1-5/16" - 12	4.04	103	1.76	45	1.62	41	6,380	44.0

## 2380F-05 **polyflex** Hose

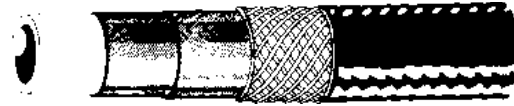

Part Number	Jacket Color	Minimum I.D.		Maximum O.D.		Maximum Working Pressure with 2.5:1 Safety Factor		Maximum Working Pressure with 4:1 Safety Factor		Minimum Burst Pressure		Minimum Bend Radius		Weight	
		inch	mm	inch	mm	psi	MPa	psi	MPa	psi	MPa	inch	mm	lbs/ft	kg/m
#															
2380F-05V07	Gray	0.32	8	0.56	14	8,700	60.0	5,437	37.5	21,750	150.0	3.35	85	0.24	0.36

**B**

**Construction:** Fluorinated ethylene-propylene polymer core tube, high strength wire reinforced and a polyurethane outer cover.

**Typical Applications:** FEP inner core offers exceptional chemical resistance for applications with aggressive fluids.

**Temperature Range:** -40°F and +140°F (-40°C and +60°C). Contact **polyflex** for temperatures outside this range. Temperatures higher than 140°F are possible. Contact division for additional information.

## National Pipe Tapered (NPT) Male Fitting

01

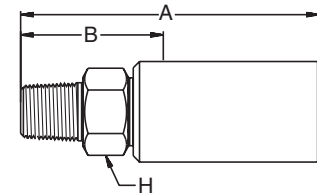

Part Number	Connection Type Thread Size	A Overall Length		B Cutoff Allowance		H Hex Size		Maximum Working Pressure	
		inch	mm	inch	mm	inch	mm	psi	MPa
#									
101NX-6-5	3/8" NPT	2.52	64	1.18	30	0.75	19	8,700	60.0

## JIC Female Swivel Fitting

06

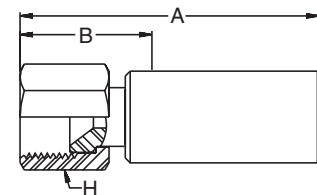

Part Number	Connection Type Thread Size	A Overall Length		B Cutoff Allowance		H Hex Size		Maximum Working Pressure	
		inch	mm	inch	mm	inch	mm	psi	MPa
#									
106NX-6-05	9/16" - 18	2.38	60	1.03	26	0.75	19	8,700	60.0

## 2380F-08 **polyflex** Hose

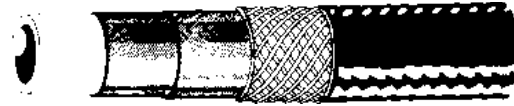

Part Number	Jacket Color	Minimum I.D.		Maximum O.D.		Maximum Working Pressure with 2.5:1 Safety Factor		Maximum Working Pressure with 4:1 Safety Factor		Minimum Burst Pressure		Minimum Bend Radius		Weight	
		inch	mm	inch	mm	psi	MPa	psi	MPa	psi	MPa	inch	mm	lbs/ft	kg/m
#															
2380F-08V07	Gray	0.50	13	0.81	21	7,540	52.0	4,710	32.5	18,850	130.0	5.51	140	0.39	0.58

**Construction:** Fluorinatedethylene-propylene polymer core tube, high strength wire reinforced and a polyurethane outer cover.

**Typical Applications:** FEP inner core offers exceptional chemical resistance for applications with aggressive fluids.

**Temperature Range:** -40°F and +140°F (-40°C and +60°C). Contact **polyflex** for temperatures outside this range. Temperatures higher than 140°F are possible. Contact division for additional information.

## National Pipe Tapered (NPT) Male Fitting 01

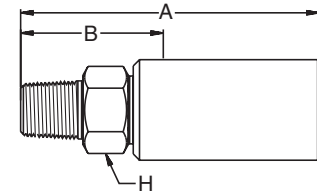

Part Number	Connection Type Thread Size	A Overall Length		B Cutoff Allowance		H Hex Size		Maximum Working Pressure	
		inch	mm	inch	mm	inch	mm	psi	MPa
#									
6019X-8-8C	1/2" NPT	3.37	86	1.68	43	1.00	25	7,540	52.0
1019X-8-8	1/2" NPT	3.35	85	1.43	36	0.87	22	7,540	52.0

## Type 'M' Female Swivel Fitting AY

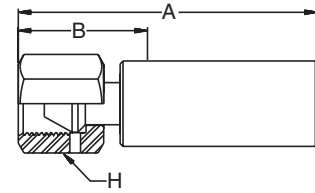

Part Number	Connection Type Thread Size	A Overall Length		B Cutoff Allowance		H Hex Size		Maximum Working Pressure	
		inch	mm	inch	mm	inch	mm	psi	MPa
#									
6AY9X-11-8C	1" - 12	3.20	81	1.50	38	1.25	32	7,540	52.0

**B**

## JIC Female Swivel Fitting 06

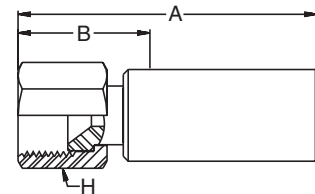

Part Number	Connection Type Thread Size	A Overall Length		B Cutoff Allowance		H Hex Size		Maximum Working Pressure	
		inch	mm	inch	mm	inch	mm	psi	MPa
#									
6069X-8-8C	3/4" - 16	3.00	76	1.30	33	0.87	22	7,540	52.0

## 2380F-12 **polyflex** Hose

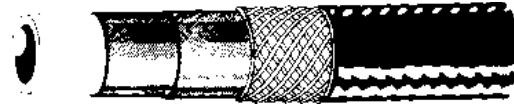

Part Number	Jacket Color	Minimum I.D.		Maximum O.D.		Maximum Working Pressure with 2.5:1 Safety Factor		Maximum Working Pressure with 4:1 Safety Factor		Minimum Burst Pressure		Minimum Bend Radius		Weight	
		inch	mm	inch	mm	psi	MPa	psi	MPa	psi	MPa	inch	mm	lbs/ft	kg/m
#															
2380F-12V07	Gray	0.76	19	1.12	28	6,380	44.0	3,987	27.5	15,950	110.0	8.07	205	0.65	0.97

**Construction:** Fluorinated ethylene-propylene polymer core tube, high strength wire reinforced and a polyurethane outer cover.

**Typical Applications:** FEP inner core offers exceptional chemical resistance for applications with aggressive fluids.

**Temperature Range:** -40°F and +140°F (-40°C and +60°C). Contact **polyflex** for temperatures outside this range. Temperatures higher than 140°F are possible. Contact division for additional information.

## National Pipe Tapered (NPT) Male Fitting

01

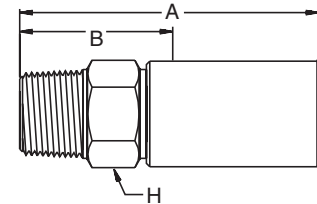



Part Number	Connection Type Thread Size	A Overall Length		B Cutoff Allowance		H Hex Size		Maximum Working Pressure	
		inch	mm	inch	mm	inch	mm	psi	MPa
#									
1019X-12-12	3/4" NPT	3.88	99	1.58	40	1.07	27	6,380	44.0
1019X-16-12	1" NPT	4.10	104	1.78	45	1.42	36	6,380	44.0

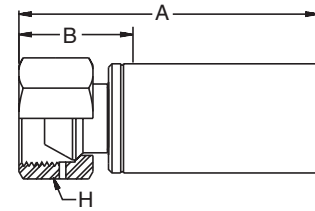

## Type "M" Female Swivel Fitting AY





Part Number	Connection Type Thread Size	A Overall Length		B Cutoff Allowance		H Hex Size		Maximum Working Pressure	
		inch	mm	inch	mm	inch	mm	psi	MPa
#									
6AYLX-16-12C	1-5/16" - 12	4.15	105	1.52	39	1.50	38	6,380	44.0

**B**

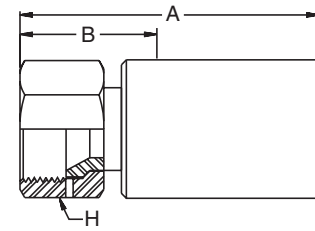
## JIC Female Swivel Fitting 06



Part Number	Connection Type Thread Size	A Overall Length		B Cutoff Allowance		H Hex Size		Maximum Working Pressure	
		inch	mm	inch	mm	inch	mm	psi	MPa
#									
1069X-12-12	1-1/16" - 12	4.00	102	1.69	43	1.42	36	6,380	44.0
1069X-16-12	1-5/16" - 12	3.93	100	1.57	40	1.62	41	6,380	44.0
606LX-16-12C	1-5/16" - 12	4.29	109	1.68	43	1.50	38	6,380	44.0

## 2380N-04 **polyflex** Hose

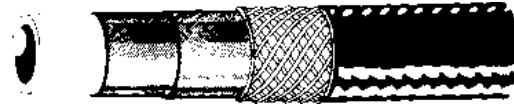

Part Number	Jacket Color	Minimum I.D.		Maximum O.D.		Maximum Working Pressure with 2.5:1 Safety Factor		Maximum Working Pressure with 4:1 Safety Factor		Minimum Burst Pressure		Minimum Bend Radius		Weight	
		inch	mm	inch	mm	psi	MPa	psi	MPa	psi	MPa	inch	mm	lbs/ft	kg/m
#															
2380N-04V00	Black	0.25	6	0.53	13	16,240	112.0	10,150	70.0	40,600	280.0	2.76	70	0.22	0.33
2380N-04V02	Blue	0.25	6	0.53	13	16,240	112.0	10,150	70.0	40,600	280.0	2.76	70	0.22	0.33
2380N-04V04	Red	0.25	6	0.53	13	16,240	112.0	10,150	70.0	40,600	280.0	2.76	70	0.22	0.33
2380N-04V71	Black	0.25	6	0.53	13	16,240	112.0	10,150	70.0	40,600	280.0	2.76	70	0.22	0.33

**Construction:** Polyamide core tube, high strength wire reinforced and a polyurethane cover.

**Temperature Range:** -40°F and +140°F (-40°C and +60°C). Contact **polyflex** for temperatures outside this range.

**Typical Applications:** Small diameter, low volumetric expansion hose. Ideal for pressure testing, portable hydraulic tools that require extreme kink resistance and maximum flexibility. Available in long single lengths and in Twin-Line construction. The -04V71 is typically used in Methanol injection applications.

## National Pipe Tapered (NPT) Male Fitting

01

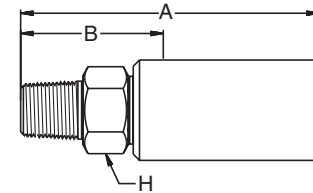

Part Number	Connection Type Thread Size	A Overall Length		B Cutoff Allowance		H Hex Size		Maximum Working Pressure	
		inch	mm	inch	mm	inch	mm	psi	MPa
#									
1018X-6-4	3/8" NPT	2.72	69	1.47	37	0.75	19	15,000	103.4
6018X-4-4	1/4" NPT	2.62	67	1.37	35	0.63	16	15,000	103.4
601LX-4-4C	1/4" NPT	2.62	67	1.37	35	0.63	16	15,000	103.4

## Type "M" Female Swivel Fitting

AY

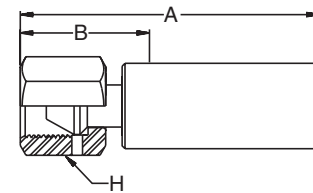

Part Number	Connection Type Thread Size	A Overall Length		B Cutoff Allowance		H Hex Size		Maximum Working Pressure	
		inch	mm	inch	mm	inch	mm	psi	MPa
#									
6AY8X-6-4	9/16" - 18	2.54	65	1.30	33	0.75	19	16,240	112.0
6AYLX-6-4C	9/16" - 18	2.69	68	1.39	35	0.68	17	16,240	112.0
6AYLX-6-4C-SD *	9/16" - 18	2.54	65	1.30	33	0.75	19	16,240	112.0

\*SD – Corrosion resistant (sea water)

## JIC Female Swivel Fitting

06

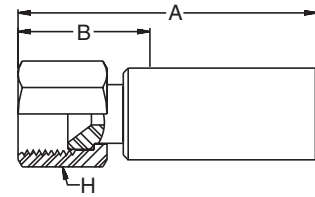

Part Number	Connection Type Thread Size	A Overall Length		B Cutoff Allowance		H Hex Size		Maximum Working Pressure	
		inch	mm	inch	mm	inch	mm	psi	MPa
#									
1068X-4-4	7/16" - 20	2.64	67	1.37	35	0.75	19	10,000	69.0
1068X-6-4	9/16" - 18	2.58	66	1.30	33	0.75	19	10,000	69.0
6069X-4-4C	7/16" - 20	2.24	57	0.98	25	0.63	16	10,000	69.0
6069X-6-4C	9/16" - 18	2.36	60	1.10	28	0.68	17	10,000	69.0

**B**

## Medium Pressure Female Swivel Fitting

5Y

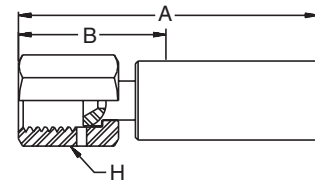

Part Number	Connection Type Thread Size	A Overall Length		B Cutoff Allowance		H Hex Size		Maximum Working Pressure	
		inch	mm	inch	mm	inch	mm	psi	MPa
#									
65Y8X-6-4	9/16" - 18	2.78	71	1.55	39	0.75	19	16,240	112.0
65YLX-6-4C	9/16" - 18	2.84	72	1.54	39	0.75	19	16,240	112.0

## BSP Female Swivel Fitting

92

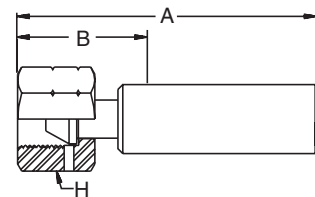

Part Number	Connection Type Thread Size	A Overall Length		B Cutoff Allowance		H Hex Size		Maximum Working Pressure	
		inch	mm	inch	mm	inch	mm	psi	MPa
#									
1928X-4-4	1/4" BSPP	2.51	64	1.27	32	0.75	19	16,240	112.0

## BSP Male Fitting

D9

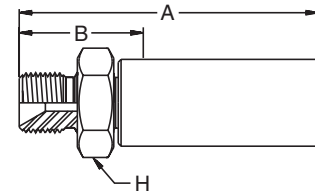

Part Number	Connection Type Thread Size	A Overall Length		B Cutoff Allowance		H Hex Size		Maximum Working Pressure	
		inch	mm	inch	mm	inch	mm	psi	MPa
#									
1D98X-4-4	1/4" BSPP	2.65	67	1.39	35	0.75	19	16,240	112.0

## Male Stecko Fitting

MB

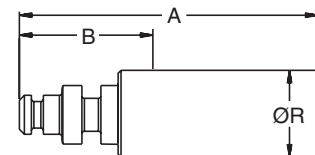

Part Number	Connection Type Thread Size	A Overall Length		B Cutoff Allowance		R Diameter		Maximum Working Pressure	
		inch	mm	inch	mm	inch	mm	psi	MPa
#									
1MB8X-6-4	None	2.85	72	1.58	40	0.86	22	10,000	69.0

## Metric Female Swivel Fitting

C3

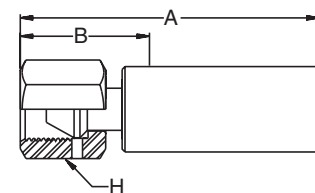

Part Number	Connection Type Thread Size	A Overall Length		B Cutoff Allowance		H Hex Size		Maximum Working Pressure	
		inch	mm	inch	mm	inch	mm	psi	MPa
#									
1C38X-4-4	M14 x 1.5	2.45	62	1.20	30	0.75	19	16,240	112.0

## 2380N-04 **polyflex** Hose

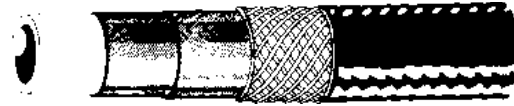

Part Number	Jacket Color	Minimum I.D.		Maximum O.D.		Maximum Working Pressure with 2.5:1 Safety Factor		Maximum Working Pressure with 4:1 Safety Factor		Minimum Burst Pressure		Minimum Bend Radius		Weight	
		inch	mm	inch	mm	psi	MPa	psi	MPa	psi	MPa	inch	mm	lbs/ft	kg/m
#															
2380N-04V33	Green	0.25	6	0.50	13	13,200	91.0	8,250	56.9	33,000	227.6	3.50	89	0.17	0.25

**B**

**Construction:** Polyamide core tube, high strength wire reinforced and a polyamide outer cover.

**Temperature Range:** -40°F and +140°F (-40°C and +60°C). Contact **polyflex** for temperatures outside this range.

**Typical Applications:** Replaces high pressure metal tubing in applications where vibration or routing constraints are issues, such as high pressure gas transfer, pressure testing, hydraulic controls, and hydraulic test systems using synthetic and phosphate ester fluids, such as Skydrol®\*\* and gas transfer service. Also used with ProLance fittings for high pressure heat exchanger tube cleaning in petrochemical and power plants.

## National Pipe Tapered (NPT) Male Fitting

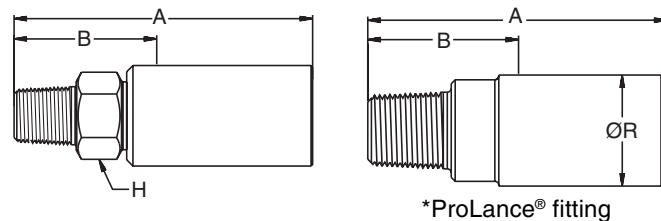

Part Number	Connection Type Thread Size	A Overall Length		B Cutoff Allowance		H Hex Size/ R Diameter		Maximum Working Pressure	
		inch	mm	inch	mm	inch	mm	psi	MPa
#									
101NX-4-4	1/4" NPT	2.57	65	1.35	34	0.63	16	13,200	91.0
101NX-6-4	3/8" NPT	2.63	67	1.38	35	0.75	19	13,200	91.0
601NX-2-4 *	1/8" NPT	1.44	37	0.50	13	0.62	16	13,200	91.0
601NX-4-4 *	1/4" NPT	1.56	40	0.63	16	0.62	16	13,200	91.0
601NX-4-4C	1/4" NPT	2.38	60	1.12	28	0.63	16	13,200	91.0

\*ProLance® fitting

Contact Technical Services for specific application information.

\*\*Skydrol® is a registered trademark of Solutia, Inc.

## National Pipe Tapered (NPT) Female Fitting

02

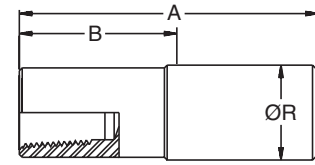

\*ProLance<sup>®</sup> fitting



Part Number	Connection Type Thread Size	A Overall Length		B Cutoff Allowance		R Diameter		Maximum Working Pressure	
		inch	mm	inch	mm	inch	mm	psi	MPa
#									
602NX-4-4 *	1/4" NPT	1.89	48	0.95	24	0.75	19	13,200	91.0

\*ProLance<sup>®</sup> fitting

## Type "M" Female Swivel Fitting

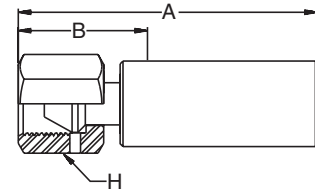
AY





Part Number	Connection Type Thread Size	A Overall Length		B Cutoff Allowance		H Hex Size		Maximum Working Pressure	
		inch	mm	inch	mm	inch	mm	psi	MPa
#									
6AYNX-6-4	9/16" - 18	2.56	65	1.32	34	0.75	19	13,200	91.0
6AYNX-6-4C	9/16" - 18	2.36	60	1.11	28	0.68	17	13,200	91.0

## JIC Female Swivel Fitting

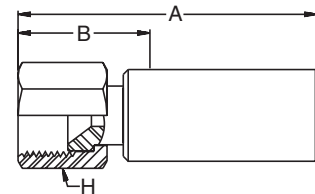
06

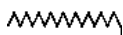



Part Number	Connection Type Thread Size	A Overall Length		B Cutoff Allowance		H Hex Size		Maximum Working Pressure	
		inch	mm	inch	mm	inch	mm	psi	MPa
#									
106NX-4-4	7/16" - 20	2.56	65	1.37	35	0.75	19	10,000	69.0
106NX-6-4	9/16" - 18	2.56	65	1.32	34	0.75	19	10,000	69.0
606NX-4-4C	7/16" - 20	2.23	57	0.99	25	0.63	16	10,000	69.0
606NX-6-4C	9/16" - 18	2.36	60	1.11	28	0.68	17	10,000	69.0

## BSP Female Swivel Fitting

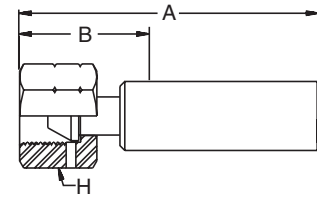
BC





Part Number	Connection Type Thread Size	A Overall Length		B Cutoff Allowance		H Hex Size		Maximum Working Pressure	
		inch	mm	inch	mm	inch	mm	psi	MPa
#									
1BCNX-4-4	1/4" BSPP	2.50	64	1.25	32	0.75	19	13,200	91.0

**B**

## BSP Male Fitting

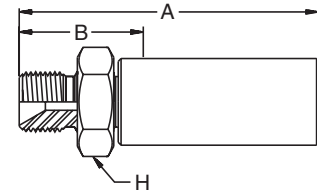
D9

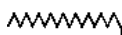



Part Number	Connection Type Thread Size	A Overall Length		B Cutoff Allowance		H Hex Size		Maximum Working Pressure	
		inch	mm	inch	mm	inch	mm	psi	MPa
#									
1D9NX-4-4	1/4" BSPP	2.64	67	1.40	36	0.75	19	13,200	91.0

## Male Water Blast Nozzle Fitting

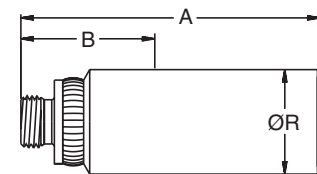
3Z



\*ProLance<sup>®</sup> fitting

Part Number	Connection Type Thread Size	A Overall Length		B Cutoff Allowance		R Diameter		Maximum Working Pressure	
		inch	mm	inch	mm	inch	mm	psi	MPa
#									
63ZNX-5-4C *	5/16" - 32	2.79	71	0.45	11	0.67	17	13,200	91.0

\*ProLance<sup>®</sup> fitting

## 2380N-05 **polyflex** Hose

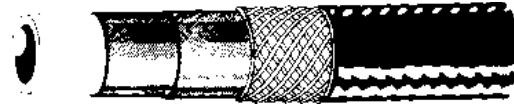

Part Number	Jacket Color	Minimum I.D.		Maximum O.D.		Maximum Working Pressure with 2.5:1 Safety Factor		Maximum Working Pressure with 4:1 Safety Factor		Minimum Burst Pressure		Minimum Bend Radius		Weight	
		inch	mm	inch	mm	psi	MPa	psi	MPa	psi	MPa	inch	mm	lbs/ft	kg/m
#															
2380N-05V00	Black	0.32	8	0.62	16	13,600	93.8	8,500	58.6	34,000	234.5	3.50	89	0.20	0.30
2380N-05V71	Black	0.32	8	0.62	16	13,600	93.8	8,500	58.6	34,000	234.5	3.50	89	0.20	0.30

**Construction:** Polyamide core tube, high strength wire reinforced and a polyurethane outer cover

**Temperature Range:** -40°F and +140°F (-40°C and +60°C). Contact **polyflex** for temperatures outside this range.

**Typical Applications:** Hydraulic tools, gas transfer, offshore chemical injection service and high pressure testing of equipment. The -05V71 is typically used in methanol injection applications.

## National Pipe Tapered (NPT) Male Fitting

01

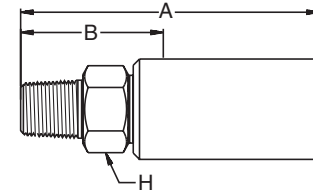



Part Number	Connection Type Thread Size	A Overall Length		B Cutoff Allowance		H Hex Size		Maximum Working Pressure	
		inch	mm	inch	mm	inch	mm	psi	MPa
#									
601LX-4-5C	1/4" NPT	2.78	71	1.18	30	0.63	16	13,600	93.8
601LX-4-5	1/4" NPT	2.78	71	1.18	30	0.63	16	13,600	93.8
601LX-6-5C	3/8" NPT	2.96	75	1.35	34	0.75	19	13,600	93.8
601LX-6-5	3/8" NPT	2.96	75	1.35	34	0.75	19	13,600	93.8

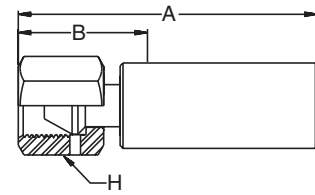

## Type "M" Female Swivel Fitting AY





Part Number	Connection Type Thread Size	A Overall Length		B Cutoff Allowance		H Hex Size		Maximum Working Pressure	
		inch	mm	inch	mm	inch	mm	psi	MPa
#									
6AY8X-8-5C *	3/4" - 16	2.95	75	1.25	32	1.00	25	13,600	93.8

\*Corrosion resistant (sea water)

**B**

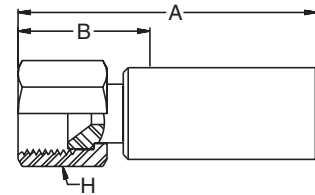
## JIC Female Swivel Fitting 06

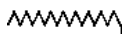

Part Number	Connection Type Thread Size	A Overall Length		B Cutoff Allowance		H Hex Size		Maximum Working Pressure	
		inch	mm	inch	mm	inch	mm	psi	MPa
#									
606LX-6-5C	9/16" - 18	2.70	69	1.10	28	0.75	19	10,000	69.0
606LX-8-5C	3/4" - 16	2.82	72	1.22	31	1.00	25	10,000	69.0

\*Corrosion resistant (sea water)

## 2390N-04 **polyflex** Hose

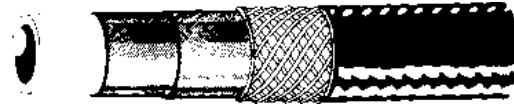

Part Number	Jacket Color	Minimum I.D.		Maximum O.D.		Working Pressure with 2.5:1 Safety Factor		Working Pressure with 4:1 Safety Factor		Minimum Burst Pressure		Minimum Bend Radius		Weight	
		inch	mm	inch	mm	psi	MPa	psi	MPa	psi	MPa	inch	mm	lbs/ft	kg/m
#															
2390N-04V10	Black	0.25	6	0.52	13	12,000	82.8	7,500	51.7	30,000	206.9	3.00	76	0.18	0.27
2390N-04V12	Blue	0.25	6	0.52	13	12,000	82.8	7,500	51.7	30,000	206.9	3.00	76	0.18	0.27
2390N-04V16	Yellow	0.25	6	0.52	13	12,000	82.8	7,500	51.7	30,000	206.9	3.00	76	0.18	0.27

**Construction:** Polyamide core tube, high tensile strength wire reinforced and a polyurethane cover.

**Temperature Range:** -40°F and +140°F (-40°C and +60°C). Contact **polyflex** for temperatures outside this range.

**Typical Applications:** Small diameter, low volumetric expansion hose with sea-water resistant cover. Ideal for pressure testing, portable hydraulic tools and for offshore hydraulic systems.

## National Pipe Tapered (NPT) Male Fitting 01

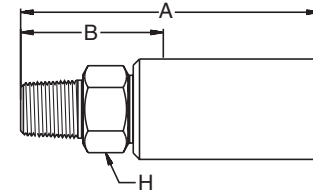

Part Number	Connection Type Thread Size	A Overall Length		B Cutoff Allowance		H Hex Size		Maximum Working Pressure	
		inch	mm	inch	mm	inch	mm	psi	MPa
#									
1018X-6-4	3/8" NPT	2.72	69	1.47	37	0.75	19	12,000	82.8
6018X-4-4	1/4" NPT	2.62	67	1.37	35	0.63	16	12,000	82.8
6019X-4-4C	1/4" NPT	2.38	60	1.12	28	0.63	16	12,000	82.8

## Type "M" Female Swivel Fitting

AY

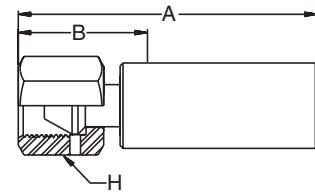

Part Number	Connection Type Thread Size	A Overall Length		B Cutoff Allowance		H Hex Size		Maximum Working Pressure	
		inch	mm	inch	mm	inch	mm	psi	MPa
#									
6AY8X-6-4	9/16" - 18	2.54	65	1.30	33	0.75	19	12,000	82.8
6AY9X-6-4C	9/16" - 18	2.36	60	1.10	28	0.68	17	12,000	82.8

**B**

## JIC Female Swivel Fitting

06

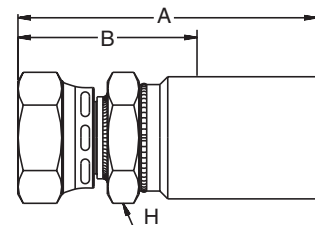
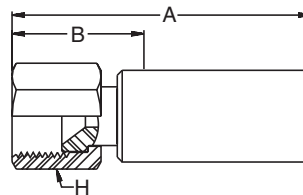

SubSea™ Fitting

Part Number	Connection Type Thread Size	A Overall Length		B Cutoff Allowance		H Hex Size		Maximum Working Pressure	
		inch	mm	inch	mm	inch	mm	psi	MPa
#									
6069X-4-4C	7/16" - 20	2.24	57	0.98	25	0.63	16	10,000	69.0
6069X-6-4C	9/16" - 18	2.36	60	1.10	28	0.68	17	10,000	69.0
E206JCC3 *	7/16" - 20	2.12	54	1.20	30	0.63	16	10,000	69.0
E206JEC3 *	9/16" - 18	2.20	56	1.12	28	0.75	19	10,000	69.0

\*SubSea™ fitting — specially manufactured for deepwater drilling applications.

## BSP Female Swivel Fitting

92

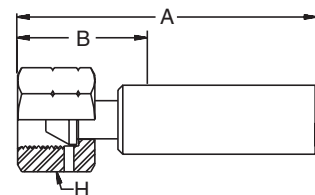



Part Number	Connection Type Thread Size	A Overall Length		B Cutoff Allowance		H Hex Size		Maximum Working Pressure	
		inch	mm	inch	mm	inch	mm	psi	MPa
#									
1928X-4-4	1/4" BSPP	2.51	64	1.27	32	0.75	19	12,000	82.8

## BSP Male Fitting

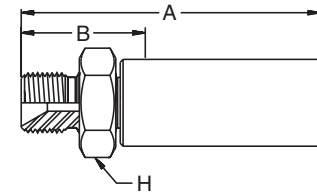
D9

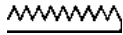



Part Number	Connection Type Thread Size	A Overall Length		B Cutoff Allowance		H Hex Size		Maximum Working Pressure	
		inch	mm	inch	mm	inch	mm	psi	MPa
#									
1D98X-4-4	1/4" BSPP	2.65	67	1.39	35	0.75	19	12,000	82.8

## Medium Pressure Female Swivel Fitting

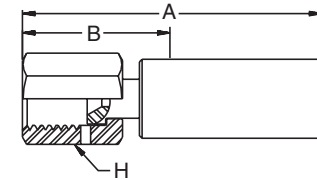
5Y



Part Number	Connection Type Thread Size	A Overall Length		B Cutoff Allowance		H Hex Size		Maximum Working Pressure	
		inch	mm	inch	mm	inch	mm	psi	MPa
#									
65Y8X-6-4	9/16" - 18	2.78	71	1.55	39	0.75	19	12,000	82.8
65YLX-6-4C	9/16" - 18	2.84	72	1.54	39	0.75	19	12,000	82.8

## 2390N-06 **polyflex** Hose

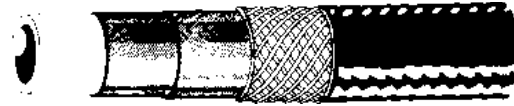

Part Number	Jacket Color	Minimum I.D.		Maximum O.D.		Working Pressure with 2.5:1 Safety Factor		Working Pressure with 4:1 Safety Factor		Minimum Burst Pressure		Minimum Bend Radius		Weight	
		inch	mm	inch	mm	psi	MPa	psi	MPa	psi	MPa	inch	mm	lbs/ft	kg/m
#															
2390N-06V13	Green	0.40	10	0.70	18	10,300	71.0	6,450	44.5	25,810	178.0	3.00	76	0.28	0.42

**B**

**Construction:** Polyamide core tube, high tensile strength wire reinforced and a polyurethane cover.

**Temperature Range:** -40°F and +140°F (-40°C and +60°C). Contact **polyflex** for temperatures outside this range.

**Typical Applications:** Low volumetric expansion hose for use with petroleum or synthetic hydraulic fluids, and in long lengths for waterblasting, pipe cleaning and line moleing applications.

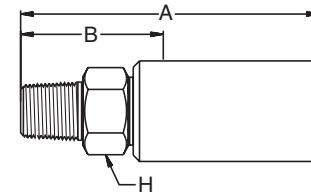

## National Pipe Tapered (NPT) Male Fitting 01



Part Number	Connection Type Thread Size	A Overall Length		B Cutoff Allowance		H Hex Size		Maximum Working Pressure	
		inch	mm	inch	mm	inch	mm	psi	MPa
#									
6019X-6-6	3/8" NPT	2.95	75	1.35	34	0.75	19	10,300	71.0
6019X-6-6C	3/8" NPT	2.95	75	1.35	34	0.75	19	10,300	71.0
6019X-8-6	1/2" NPT	3.16	80	1.56	40	0.87	22	10,300	71.0
6019X-8-6C	1/2" NPT	3.16	80	1.56	40	0.87	22	10,300	71.0

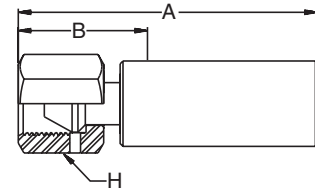

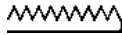
## Type "M" Female Swivel Fitting AY

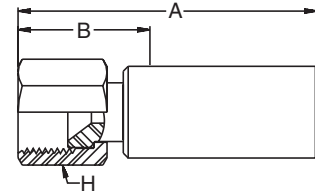

Part Number	Connection Type Thread Size	A Overall Length		B Cutoff Allowance		H Hex Size		Maximum Working Pressure	
		inch	mm	inch	mm	inch	mm	psi	MPa
#									
6AY9X-8-6C	3/4" - 16	2.79	71	1.19	30	1.00	25	10,300	71.0

## JIC Female Swivel Fitting 06



Part Number	Connection Type Thread Size	A Overall Length		B Cutoff Allowance		H Hex Size		Maximum Working Pressure	
		inch	mm	inch	mm	inch	mm	psi	MPa
#									
6069X-8-6C	3/4" - 16	2.79	71	1.19	30	1.00	25	10,000	69.0

## 2390N-08 **polyflex** Hose

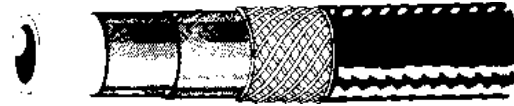

Part Number	Jacket Color	Minimum I.D.		Maximum O.D.		Maximum Working Pressure with 2.5:1 Safety Factor		Maximum Working Pressure with 4:1 Safety Factor		Minimum Burst Pressure		Minimum Bend Radius		Weight	
		inch	mm	inch	mm	psi	MPa	psi	MPa	psi	MPa	inch	mm	lbs/ft	kg/m
#															
2390N-08V12	Blue	0.50	13	0.81	21	10,400	71.7	6,500	44.8	26,000	179.3	4.00	102	0.38	0.57
2390N-08V13	Green	0.50	13	0.81	21	10,400	71.7	6,500	44.8	26,000	179.3	4.00	102	0.38	0.57
2390N-08V16	Yellow	0.50	13	0.81	21	10,400	71.7	6,500	44.8	26,000	179.3	4.00	102	0.38	0.57

**B**

**Construction:** Polyamide core tube, high strength wire reinforced and a polyurethane outer cover.

**Temperature Range:** -40°F and +140°F (-40°C and +60°C). Contact **polyflex** for temperatures outside this range.

**Typical Applications:** Low volumetric expansion hose with sea-water resistant cover. Used in subsea hydraulic B.O.P. control systems, and in long lengths for pipe cleaning applications.

## National Pipe Tapered (NPT) Male Fitting 01

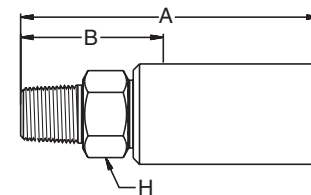

Part Number	Connection Type Thread Size	A Overall Length		B Cutoff Allowance		H Hex Size		Maximum Working Pressure	
		inch	mm	inch	mm	inch	mm	psi	MPa
#									
6019X-8-8	1/2" NPT	3.35	85	1.43	36	0.87	22	10,400	71.7
6019X-8-8C	1/2" NPT	3.37	86	1.68	43	1.00	25	10,400	71.7

## Type "M" Female Swivel Fitting AY

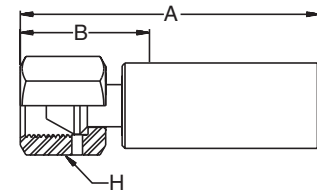

Part Number	Connection Type Thread Size	A Overall Length		B Cutoff Allowance		H Hex Size		Maximum Working Pressure	
		inch	mm	inch	mm	inch	mm	psi	MPa
#									
6AY9X-11-8C	1" - 12	3.20	81	1.50	38	1.25	32	10,400	71.7

## JIC Female Swivel Fitting 06

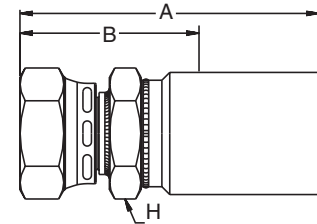
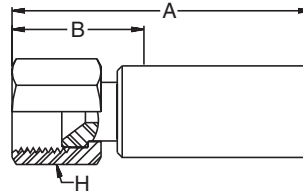

\*SubSea Fitting

Part Number	Connection Type Thread Size	A Overall Length		B Cutoff Allowance		H Hex Size		Maximum Working Pressure	
		inch	mm	inch	mm	inch	mm	psi	MPa
#									
6069X-8-8C	3/4" - 16	3.00	76	1.30	33	0.87	22	10,000	69.0
E213JFC4 *	3/4" - 16	3.35	85	1.61	41	0.94	24	10,000	69.0

\*SubSea fitting



## 2390N-12 **polyflex** Hose

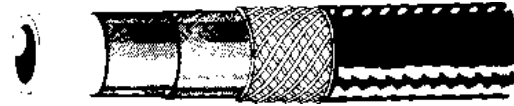

Part Number	Jacket Color	Minimum I.D.		Maximum O.D.		Maximum Working Pressure with 2.5:1 Safety Factor		Maximum Working Pressure with 4:1 Safety Factor		Minimum Burst Pressure		Minimum Bend Radius		Weight	
		inch	mm	inch	mm	psi	MPa	psi	MPa	psi	MPa	inch	mm	lbs/ft	kg/m
#															
2390N-12V03	Green	0.81	21	1.14	29	8,100	55.9	5,575	38.4	22,300	153.8	6.00	152	0.63	0.94

**B**

**Construction:** Polyamide core tube, high strength wire reinforced and a polyurethane outer cover.

**Temperature Range:** -40°F and +140°F (-40°C and +60°C). Contact **polyflex** for temperatures outside this range.

**Typical Applications:** Flexible, kink-resistant construction suitable for chemical fluids and operations of hydraulic tools and equipment.

## National Pipe Tapered (NPT) Male Fitting

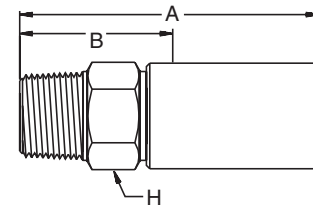

01



Part Number	Connection Type Thread Size	A Overall Length		B Cutoff Allowance		H Hex Size		Maximum Working Pressure	
		inch	mm	inch	mm	inch	mm	psi	MPa
#									
6019X-12-12	3/4" NPT	3.88	99	1.58	40	1.07	27	8,100	55.9
1019X-16-12	1" NPT	4.10	104	1.78	45	1.42	36	8,100	55.9
601LX-12-12C	3/4" NPT	4.75	121	2.10	53	1.38	35	8,100	55.9
601LX-16-12C	1" NPT	4.90	124	2.25	57	1.38	35	8,100	55.9

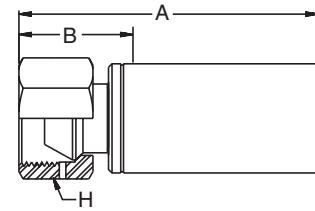

## Type "M" Female Swivel Fitting AY

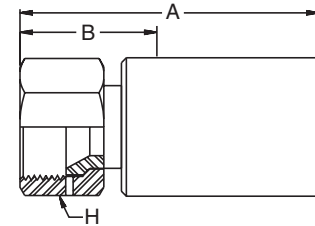

Part Number	Connection Type Thread Size	A Overall Length		B Cutoff Allowance		H Hex Size		Maximum Working Pressure	
		inch	mm	inch	mm	inch	mm	psi	MPa
#									
6AYLX-16-12C	1-5/16" - 12	4.15	105	1.52	39	1.50	38	8,100	55.9

## JIC Female Swivel Fitting 06



Part Number	Connection Type Thread Size	A Overall Length		B Cutoff Allowance		H Hex Size		Maximum Working Pressure	
		inch	mm	inch	mm	inch	mm	psi	MPa
#									
1069X-12-12	1-1/16" - 12	4.00	102	1.69	43	1.42	36	8,100	55.9
1069X-16-12	1-5/16" - 12	3.93	100	1.57	40	1.62	41	8,100	55.9
606LX-16-12C	1-5/16" - 12	4.29	109	1.68	43	1.50	38	8,100	55.9

## 2390N-16 **polyflex** Hose

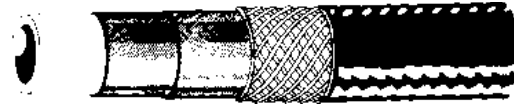

Part Number	Jacket Color	Minimum I.D.		Maximum O.D.		Maximum Working Pressure with 2.5:1 Safety Factor		Maximum Working Pressure with 4:1 Safety Factor		Minimum Burst Pressure		Minimum Bend Radius		Weight	
		#	inch	mm	inch	mm	psi	MPa	psi	MPa	psi	MPa	inch	mm	lbs/ft
2390N-16V12	Blue	1.00	25	1.37	35	6,500	44.8	4,100	28.3	16,420	113.2	8.00	203	0.84	1.25
2390N-16V13	Green	1.00	25	1.37	35	6,500	44.8	4,100	28.3	16,420	113.2	8.00	203	0.84	1.25
2390N-16V16	Yellow	1.00	25	1.37	35	6,500	44.8	4,100	28.3	16,420	113.2	8.00	203	0.84	1.25

**B**

**Construction:** Polyamide core tube, high strength wire reinforced and a polyurethane outer cover.

**Temperature Range:** -40°F and +140°F (-40°C and +60°C). Contact **polyflex** for temperatures outside this range.

**Typical Applications:** Low volumetric expansion hose with sea-water resistant cover. Used for subsea hydraulic controls, and as long single length hot-line hose for B.O.P. systems.

## National Pipe Tapered (NPT) Male Fitting 01

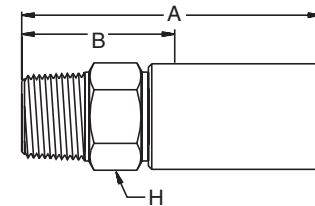

Part Number	Connection Type Thread Size	A Overall Length		B Cutoff Allowance		H Hex Size		Maximum Working Pressure	
		#	inch	mm	inch	mm	inch	mm	psi
1019X-16-16	1" NPT	4.10	104	1.78	45	1.42	36	6,500	44.8
6019X-16-16C	1" NPT	4.38	111	2.25	57	1.38	35	6,500	44.8

## Type "M" Female Swivel Fitting AY

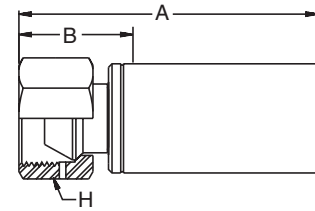

Part Number	Connection Type Thread Size	A Overall Length		B Cutoff Allowance		H Hex Size		Maximum Working Pressure	
		inch	mm	inch	mm	inch	mm	psi	MPa
#									
6AY9X-16-16C	1-5/16" - 12	3.79	96	1.65	42	1.50	38	6,500	44.8

## JIC Female Swivel Fitting 06

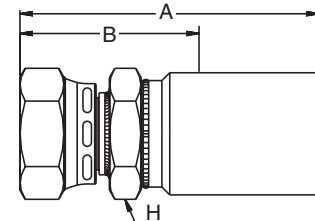
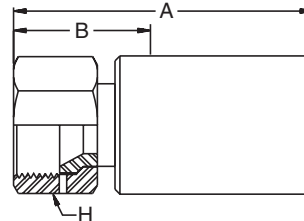

\*SubSea Fitting

Part Number	Connection Type Thread Size	A Overall Length		B Cutoff Allowance		H Hex Size		Maximum Working Pressure	
		inch	mm	inch	mm	inch	mm	psi	MPa
#									
1069X-16-16	1-5/16" - 12	4.04	103	1.76	45	1.62	41	6,500	44.8
6069X-16-16C	1-5/16" - 12	3.79	96	1.65	42	1.50	38	6,500	44.8
E225JIC3 *	1-5/16" - 12	4.30	109	2.10	53	1.63	41	6,500	44.8

\*SubSea fitting

## 2440D-025 **polyflex** Hose



Part Number	Jacket Color	Minimum I.D.		Maximum O.D.		Maximum Working Pressure		Minimum Burst Pressure		Minimum Bend Radius		Weight	
		inch	mm	inch	mm	psi	MPa	psi	MPa	inch	mm	lbs/ft	kg/m
#													
2440D-025V37	Gray	0.16	4	0.37	9	31,900	220.0	79,750	550.0	4.10	104	0.13	0.19

**B**

**Construction:** Polyoxymethylene core tube, high strength wire reinforced and a polyamide outer cover.

**Temperature Range:** -40°F and +140°F (-40°C and +60°C). Contact **polyflex** for temperatures outside this range.

**Typical Applications:** Small diameter flexible hose. Ideal for tight routing applications such as hydraulic tools and high pressure heat exchanger tube cleaning in petrochemical and power plants. Especially suitable for hydraulic pre-tensioning equipment and specialized pressure fitted sleeve and coupling removal equipment.

## National Pipe Tapered (NPT) Male Fitting 01

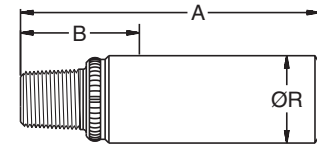

Part Number	Connection Type Thread Size	A Overall Length		B Cutoff Allowance		H Hex Size		Maximum Working Pressure	
		inch	mm	inch	mm	inch	mm	psi	MPa
#									
601LX-2-2AC	1/8" NPT ProLance	1.90	48	0.76	19	0.50	13	15,000	103.4

## Type "M" Female Swivel Fitting AY

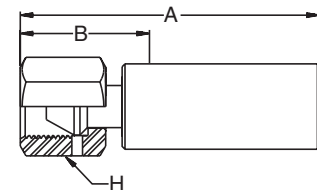

Part Number	Connection Type Thread Size	A Overall Length		B Cutoff Allowance		H Hex Size		Maximum Working Pressure	
		inch	mm	inch	mm	inch	mm	psi	MPa
#									
6AYLX-6-2AC	9/16" - 18	2.51	64	1.28	33	0.68	17	31,900	220.0

## High Pressure Tube Nipple

Y4

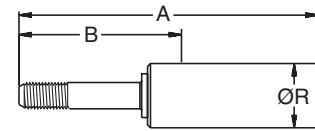

Part Number	Connection Type Thread Size	A Overall Length		B Cutoff Allowance		R Diameter		Maximum Working Pressure	
		inch	mm	inch	mm	inch	mm	psi	MPa
#									
6Y4LX-4-2AC	1/4" - 28 LH	2.96	75	1.71	43	0.63	16	31,900	220.0
6Y4LX-6-2AC	3/8" - 24 LH	3.40	86	2.16	55	0.63	16	31,900	220.0

## Nozzle Nipples

YH

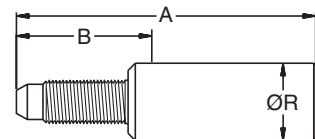

Part Number	Connection Type Thread Size	A Overall Length		B Cutoff Allowance		R Diameter		Maximum Working Pressure	
		inch	mm	inch	mm	inch	mm	psi	MPa
#									
6YHLX-4-2AC	1/4" - 28 LH	2.10	53	0.87	22	0.50	13	31,900	220.0

## Right Hand Female for Water Blast Nozzle Fitting

EY

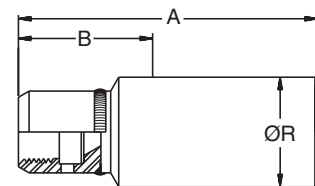

Part Number	Connection Type Thread Size	A Overall Length		B Cutoff Allowance		R Diameter		Maximum Working Pressure	
		inch	mm	inch	mm	inch	mm	psi	MPa
#									
E404UAC1	1/4" - 28 RH	1.91	49	0.81	21	0.5	13	31,900	220.0

## 2440D-03 **polyflex** Hose



Part Number	Jacket Color	Minimum I.D.		Maximum O.D.		Maximum Working Pressure		Minimum Burst Pressure		Minimum Bend Radius		Weight	
		inch	mm	inch	mm	psi	MPa	psi	MPa	inch	mm	lbs/ft	kg/m
#													
2440D-03V37	Gray	0.20	5	0.45	11	26,100	180.0	65,250	450.0	5.12	130	0.19	0.28

**B**

**Construction:** Polyoxymethylene core tube, high strength wire reinforced and a polyamide outer cover.

**Temperature Range:** -40°F and +140°F (-40°C and +60°C). Contact **polyflex** for temperatures outside this range.

**Typical Applications:** Small diameter flexible hose. Ideal for tight routing applications such as hydraulic tools, pressure testing and high pressure heat exchanger tube cleaning, and other water blasting applications in petrochemical and power plants and general industry. Especially suitable for hydraulic pre-tensioning equipment and specialized pressure fitted sleeve and coupling removal equipment.

## National Pipe Tapered (NPT) Male Fitting

01

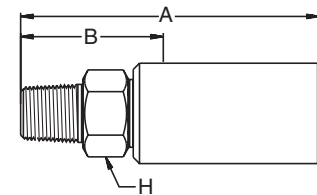

Part Number	Connection Type Thread Size	A Overall Length		B Cutoff Allowance		H Hex Size		Maximum Working Pressure	
		inch	mm	inch	mm	inch	mm	psi	MPa
#									
601LX-4-3	1/4" NPT	2.86	73	1.30	33	0.56	14	15,000	103.4

## Type "M" Female Swivel Fitting

AY

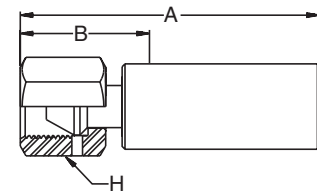

Part Number	Connection Type Thread Size	A Overall Length		B Cutoff Allowance		H Hex Size		Maximum Working Pressure	
		inch	mm	inch	mm	inch	mm	psi	MPa
#									
6AYLX-6-3	9/16" - 18	2.80	71	1.28	33	0.75	19	26,100	180.0
6AYLX-6-3C	9/16" - 18	2.93	74	1.42	36	0.68	17	26,100	180.0

## High Pressure Tube Nipple

Y4

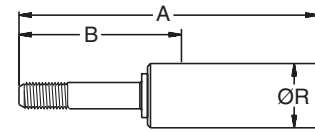

Part Number	Connection Type Thread Size	A Overall Length		B Cutoff Allowance		R Diameter		Maximum Working Pressure	
		inch	mm	inch	mm	inch	mm	psi	MPa
#									
6Y4LX-6-3C	3/8" - 24 LH	3.86	98	2.35	60	0.67	17	26,100	180.0
6Y4LX-9-3C	9/16" - 18 LH	4.20	107	2.70	69	0.67	17	26,100	180.0

## Nozzle Nipples

YH

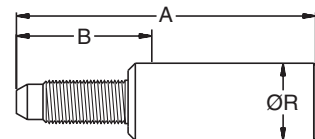

Part Number	Connection Type Thread Size	A Overall Length		B Cutoff Allowance		R Diameter		Maximum Working Pressure	
		inch	mm	inch	mm	inch	mm	psi	MPa
#									
6YHLX-4-3C	1/4" - 28 LH	2.71	69	1.52	39	0.60	15	26,100	180.0
6YHLX-6-3C	3/8" - 24 LH	2.61	66	1.41	36	0.60	15	26,100	180.0
E405UDA2	3/8" - 24 RH	2.61	66	1.41	36	0.60	15	26,100	180.0

## High Pressure Female Swivel Fitting

6Y

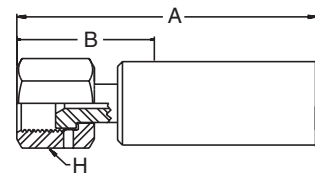

Part Number	Connection Type Thread Size	A Overall Length		B Cutoff Allowance		H Hex Size		Maximum Working Pressure	
		inch	mm	inch	mm	inch	mm	psi	MPa
#									
66YLX-4-3	9/16" - 18	2.80	71	1.28	33	0.75	19	26,100	180.0
66YLX-4-3C	9/16" - 18	2.93	74	1.42	36	0.68	17	26,100	180.0



## Medium Pressure Female Swivel Fitting 5Y

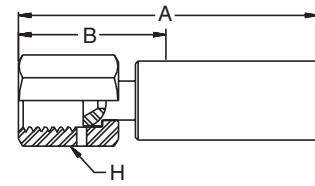

Part Number	Connection Type Thread Size	A Overall Length		B Cutoff Allowance		H Hex Size		Maximum Working Pressure	
		inch	mm	inch	mm	inch	mm	psi	MPa
#									
65YLX-6-3	9/16" - 18	3.08	78	1.53	39	0.75	19	20,000	137.9

**B**

## BSP Female Swivel Fitting 92

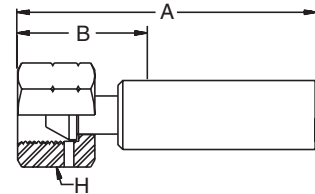

Part Number	Connection Type Thread Size	A Overall Length		B Cutoff Allowance		H Hex Size		Maximum Working Pressure	
		inch	mm	inch	mm	inch	mm	psi	MPa
#									
192LX-4-3	1/4" BSPP	2.95	75	1.38	35	0.75	19	26,100	180.0
692LX-4-3C	1/4" BSPP	2.83	72	1.30	33	0.88	22	26,100	180.0

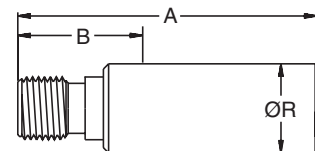

## Right Hand Male for Water Blast Nozzle Fitting

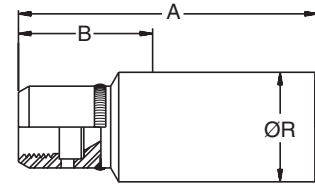

Part Number	Connection Type Thread Size	A Overall Length		B Cutoff Allowance		R Diameter		Maximum Working Pressure	
		inch	mm	inch	mm	inch	mm	psi	MPa
#									
E405UBA1	5/16" - 24	2.22	56	1.10	28	0.60	15	20,000	137.9

# Right Hand Female for Water Blast Nozzle Fitting EY

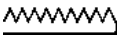

Part Number	Connection Type Thread Size	A Overall Length		B Cutoff Allowance		R Diameter		Maximum Working Pressure	
		inch	mm	inch	mm	inch	mm	psi	MPa
#									
6EYLX-6-3C	3/8" - 24 RH	1.98	50	0.70	18	0.63	16	26,100	180.0

## 2440N-04 **polyflex** Hose



Part Number	Jacket Color	Minimum I.D.		Maximum O.D.		Maximum Working Pressure		Minimum Burst Pressure		Minimum Bend Radius		Weight	
		inch	mm	inch	mm	psi	MPa	psi	MPa	inch	mm	lbs/ft	kg/m
#													
2440N-04V37	Gray	0.25	6	0.50	13	23,780	164.0	59,450	410.0	6.10	155	0.22	0.33
2440N-04V71	Gray	0.25	6	0.50	13	23,780	164.0	59,450	410.0	6.10	155	0.22	0.33

**B**

**Construction:** Polyamide core tube, high strength wire reinforced and a polyamide outer cover.

**Temperature Range:** -40°F and +140°F (-40°C and +60°C). Contact **polyflex** for temperatures outside this range.

**Typical Applications:** Small diameter, chemical resistant hose for hydraulic tools, pressure testing, offshore chemical injection and high pressure heat exchanger tube cleaning in petrochemical and power plants. The -04V71 is typically used in methanol injection applications.

## National Pipe Tapered (NPT) Male Fitting

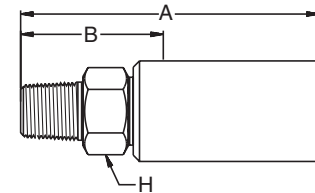

01

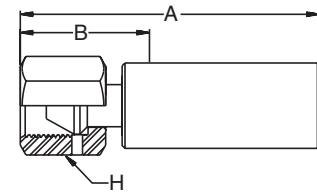

Part Number	Connection Type Thread Size	A Overall Length		B Cutoff Allowance		H Hex Size		Maximum Working Pressure	
		inch	mm	inch	mm	inch	mm	psi	MPa
#									
601LX-2-4	1/8" NPT	2.50	64	1.20	30	0.63	16	15,000	103.4
601LX-4-4	1/4" NPT	2.61	66	1.32	33	0.63	16	15,000	103.4
601LX-4-4C	1/4" NPT	2.62	67	1.34	34	0.63	16	15,000	103.4

## Type "M" Female Swivel Fitting AY

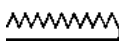



Part Number	Connection Type Thread Size	A Overall Length		B Cutoff Allowance		H Hex Size		Maximum Working Pressure	
		inch	mm	inch	mm	inch	mm	psi	MPa
#									
6AYLX-6-4	9/16" - 18	2.63	67	1.32	33	0.75	19	23,780	164.0
6AYLX-6-4C	9/16" - 18	2.69	68	1.39	35	0.68	17	23,780	164.0
6AYLX-6-4C-SD *	9/16" - 18	2.69	68	1.39	35	0.68	17	23,780	164.0

\*SD = Corrosion Resistant (seawater) — specially designed for aggressive fluids found in offshore drilling applications.

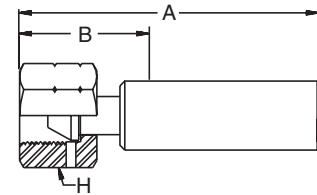

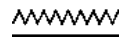
## BSP Female Swivel Fitting 92



Part Number	Connection Type Thread Size	A Overall Length		B Cutoff Allowance		H Hex Size		Maximum Working Pressure	
		inch	mm	inch	mm	inch	mm	psi	MPa
#									
692LX-4-4	1/4" BSPP	2.51	64	1.21	31	0.87	22	23,780	164.0

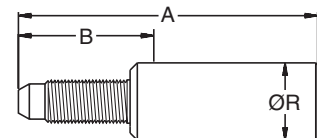

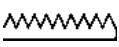
## Nozzle Nipples YH

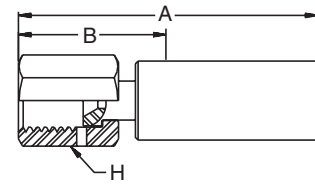

Part Number	Connection Type Thread Size	A Overall Length		B Cutoff Allowance		R Diameter		Maximum Working Pressure	
		inch	mm	inch	mm	inch	mm	psi	MPa
#									
6YHLX-6-4C	3/8" - 24 LH	2.60	66	1.41	36	0.67	17	20,000	137.9

## Medium Pressure Female Swivel Fitting 5Y





Part Number	Connection Type Thread Size	A Overall Length		B Cutoff Allowance		H Hex Size		Maximum Working Pressure	
		inch	mm	inch	mm	inch	mm	psi	MPa
#									
65YLX-6-4	9/16" - 18	2.84	72	1.54	39	0.75	19	20,000	137.9
65YLX-6-4C	9/18" - 18	2.84	72	1.54	39	0.75	19	20,000	137.9

**B**

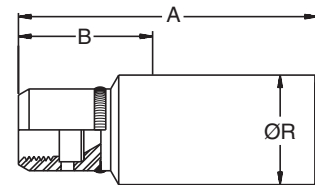
## Right Hand Female for Water Blast Nozzle Fitting EY

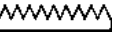

Part Number	Connection Type Thread Size	A Overall Length		B Cutoff Allowance		R Diameter		Maximum Working Pressure	
		inch	mm	inch	mm	inch	mm	psi	MPa
#									
6EYLX-6-4C	3/8" - 24 RH	1.83	46	0.60	15	0.67	17	20,000	137.9

## 2440D-05 **polyflex** Hose



Part Number	Jacket Color	Minimum I.D.		Maximum O.D.		Maximum Working Pressure		Minimum Burst Pressure		Minimum Bend Radius		Weight	
		inch	mm	inch	mm	psi	MPa	psi	MPa	inch	mm	lbs/ft	kg/m
#													
2440D-05V37	Gray	0.32	8	0.61	15	21,750	150.0	54,500	375.9	6.88	175	0.30	0.45

**Construction:** Polyoxymethylene core tube, high strength wire reinforced and a polyamide outer cover.

**Temperature Range:** -40°F and +140°F (-40°C and +60°C). Contact **polyflex** for temperatures outside this range.

**Typical Applications:** Chemical resistant hose for hydraulic tools, pressure testing of offshore equipment and high pressure heat exchanger tube cleaning in petrochemical and power plants.

## National Pipe Tapered (NPT) Male Fitting 01

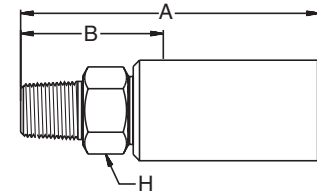

Part Number	Connection Type Thread Size	A Overall Length		B Cutoff Allowance		H Hex Size		Maximum Working Pressure	
		inch	mm	inch	mm	inch	mm	psi	MPa
#									
601LX-4-5	1/4" NPT	2.78	71	1.18	30	0.63	16	15,000	103.4
601LX-4-5C	1/4" NPT	2.78	71	1.18	30	0.63	16	15,000	103.4
601LX-6-5	3/8" NPT	2.96	75	1.37	35	0.75	19	15,000	103.4
601LX-6-5C	3/8" NPT	2.96	75	1.37	35	0.75	19	15,000	103.4

## Type "M" Female Swivel Fitting AY

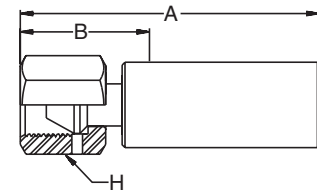

Part Number	Connection Type Thread Size	A Overall Length		B Cutoff Allowance		H Hex Size		Maximum Working Pressure	
		inch	mm	inch	mm	inch	mm	psi	MPa
#									
6AYLX-8-5C	3/4" - 16	2.95	75	1.25	32	1.00	25	21,750	150.0

## Medium Pressure Tube Nipple

Y2

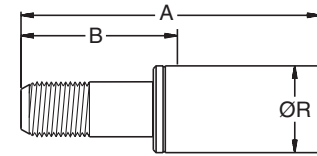

Part Number	Connection Type Thread Size	A Overall Length		B Cutoff Allowance		R Diameter		Maximum Working Pressure	
		inch	mm	inch	mm	inch	mm	psi	MPa
#									
6Y2LX-9-5C	9/16" - 18 LH	3.83	97	2.13	54	0.95	24	20,000	137.9
6Y2LX-12-5C	3/4" - 16 LH	3.74	95	2.05	52	0.95	24	20,000	137.9
E408LCA2	9/16" - 18 LH (Long Tube)	4.53	115	2.83	72	0.95	24	20,000	137.9
E408LCA3	9/16" - 18 LH (7/8" Thread)	3.83	97	2.13	54	0.95	24	20,000	137.9

**B**

## Left Hand Female for Water Blast Nozzle Fitting

EY

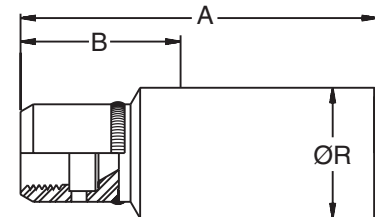

Part Number	Connection Type Thread Size	A Overall Length		B Cutoff Allowance		R Diameter		Maximum Working Pressure	
		inch	mm	inch	mm	inch	mm	psi	MPa
#									
6EYLY-9-5C	9/16" - 18 LH	2.60	66	0.88	22	0.82	21	20,000	137.9

## BSP Female Swivel Fitting

92

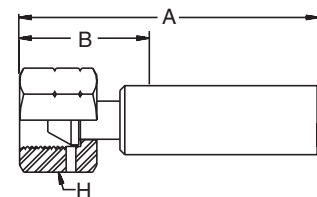

Part Number	Connection Type Thread Size	A Overall Length		B Cutoff Allowance		H Hex Size		Maximum Working Pressure	
		inch	mm	inch	mm	inch	mm	psi	MPa
#									
692LX-6-5C	3/8" BSPP	2.90	74	1.20	30	1.06	27	21,750	150.0

## 2440N-06 **polyflex** Hose



Part Number	Jacket Color	Minimum I.D.		Maximum O.D.		Maximum Working Pressure		Minimum Burst Pressure		Minimum Bend Radius		Weight	
		inch	mm	inch	mm	psi	MPa	psi	MPa	inch	mm	lbs/ft	kg/m
#													
2440N-06V91	Black	0.40	10	0.77	20	20,300	140.0	50,750	350.0	7.50	191	0.47	0.70

**Construction:** Polyoxymethylene core tube, high strength wire reinforced and a polyamide outer cover.

**Temperature Range:** -40°F and +140°F (-40°C and +60°C). Contact **polyflex** for temperatures outside this range.

**Typical Applications:** Chemical resistant hose for hydraulic tools, pressure testing of offshore equipment and high pressure heat exchanger tube cleaning in petrochemical and power plants.

## Type "M" Female Swivel Fitting AY

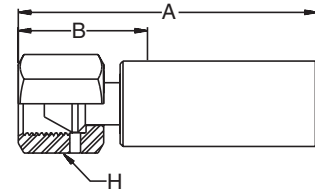

Part Number	Connection Type Thread Size	A Overall Length		B Cutoff Allowance		H Hex Size		Maximum Working Pressure	
		inch	mm	inch	mm	inch	mm	psi	MPa
#									
6AYLX-8-6C	3/4" - 16	2.95	75	1.25	32	1.00	25	21,750	150.0



## 2440N-08 **polyflex** Hose



Part Number	Jacket Color	Minimum I.D.		Maximum O.D.		Maximum Working Pressure		Minimum Burst Pressure		Minimum Bend Radius		Weight	
		inch	mm	inch	mm	psi	MPa	psi	MPa	inch	mm	lbs/ft	kg/m
#													
2440N-08V37	Gray	0.50	13	0.88	22	20,400	140.7	51,000	351.7	7.87	200	0.63	0.94
2440N-08V71	Gray	0.50	13	0.88	22	20,400	140.7	51,000	351.7	7.87	200	0.63	0.94

**B**

**Construction:** Polyamide core tube, high strength wire reinforced and a polyamide outer cover.

**Temperature Range:** -40°F and +140°F (-40°C and +60°C). Contact **polyflex** for temperatures outside this range.

**Typical Applications:** Flexible, lightweight, chemical resistant alternative to steel pipe and rubber hose for applications such as waterblasting, gas transfer, chemical injection, wireline logging services, and pressure testing. The -08V71 is typically used in methanol injection applications.

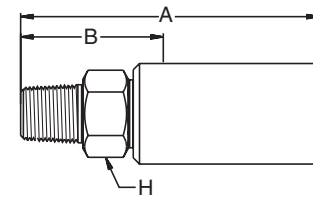

## National Pipe Tapered (NPT) Male Fitting 01

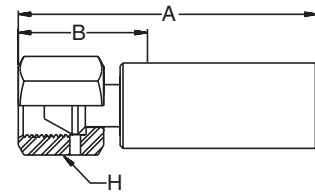

Part Number	Connection Type Thread Size	A Overall Length		B Cutoff Allowance		H Hex Size		Maximum Working Pressure	
		inch	mm	inch	mm	inch	mm	psi	MPa
#									
601LX-8-8	1/2" NPT	3.75	95	1.70	43	1.13	29	15,000	103.4
601LX-8-8C	1/2" NPT	3.75	95	1.70	43	1.13	29	15,000	103.4

## Type "M" Female Swivel Fitting AY

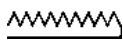



Part Number	Connection Type Thread Size	A Overall Length		B Cutoff Allowance		H Hex Size		Maximum Working Pressure	
		inch	mm	inch	mm	inch	mm	psi	MPa
#									
6AYLX-11-8C	1" - 12	3.53	90	1.50	38	1.25	32	20,400	140.7
6AYLX-11-8C-SD *	1" - 12	3.53	90	1.50	38	1.25	32	20,400	140.7

\*SD = Corrosion Resistant (seawater) — specially designed for aggressive fluids found in offshore drilling applications.

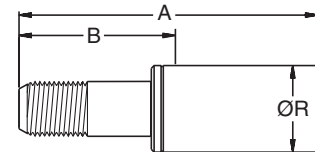

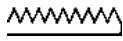
## Medium Pressure Tube Nipples Y2

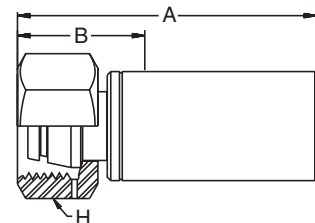

Part Number	Connection Type Thread Size	A Overall Length		B Cutoff Allowance		R Diameter		Maximum Working Pressure	
		inch	mm	inch	mm	inch	mm	psi	MPa
#									
6Y2LX-9-8C	9/16" - 18 LH	4.20	107	2.20	56	1.13	29	20,000	137.9
6Y2LX-12-8C	3/4" - 16 LH	4.13	105	2.08	53	1.13	29	20,000	137.9

## Metric Female Swivel Fitting C9

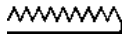

Part Number	Connection Type Thread Size	A Overall Length		B Cutoff Allowance		H Hex Size		Maximum Working Pressure	
		inch	mm	inch	mm	inch	mm	psi	MPa
#									
6C9LX-16-8C	M24 x 1.5	3.48	88	1.44	37	1.26	32	20,000	137.9

## 2440N-12 **polyflex** Hose



Part Number	Jacket Color	Minimum I.D.		Maximum O.D.		Maximum Working Pressure		Minimum Burst Pressure		Minimum Bend Radius		Weight	
		inch	mm	inch	mm	psi	MPa	psi	MPa	inch	mm	lbs/ft	kg/m
#													
2440N-12V37	Gray	0.81	21	1.19	30	14,500	100.0	37,500	258.6	10.00	254	0.93	1.39
2440N-12V71	Gray	0.81	21	1.19	30	14,500	100.0	37,500	258.6	10.00	254	0.93	1.39

**B**

**Construction:** Polyamide core tube, high strength wire reinforced and a polyamide outer cover.

**Temperature Range:** -40°F and +140°F (-40°C and +60°C). Contact **polyflex** for temperatures outside this range.

**Typical Applications:** Flexible, chemical resistant alternative to steel pipe for applications such as water-blasting, hydrodemolition, gas transfer, hydraulic workover and chemical injection. The -12V71 is typically used in Methanol injection applications.

## National Pipe Tapered (NPT) Male Fitting

01

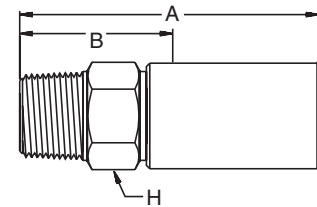

Part Number	Connection Type Thread Size	A Overall Length		B Cutoff Allowance		H Hex Size		Maximum Working Pressure	
		inch	mm	inch	mm	inch	mm	psi	MPa
#									
601LX-12-12C	3/4" NPT	4.75	121	2.10	53	1.38	35	10,000	69.0
601LX-16-12C	1" NPT	4.90	124	2.25	57	1.38	35	10,000	69.0

## Type "M" Female Swivel Fitting

AY

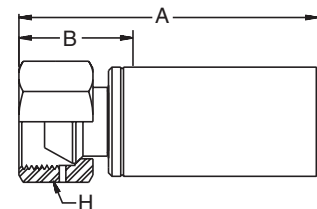

Part Number	Connection Type Thread Size	A Overall Length		B Cutoff Allowance		H Hex Size		Maximum Working Pressure	
		inch	mm	inch	mm	inch	mm	psi	MPa
#									
6AYLX-16-12C	1-5/16" - 12	4.15	105	1.52	39	1.50	38	15,000	103.4
6AYLX-16-12C-SD *	1-5/16" - 12	4.29	109	1.64	42	1.50	38	15,000	103.4

\*SD = Corrosion Resistant (seawater) — specially designed for aggressive fluids found in offshore drilling applications.

## Medium Pressure Tube Nipples

Y2

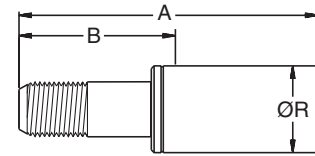

Part Number	Connection Type Thread Size	A Overall Length		B Cutoff Allowance		R Diameter		Maximum Working Pressure	
		inch	mm	inch	mm	inch	mm	psi	MPa
#									
6Y2LX-16-12C	1" - 14 LH	5.39	137	2.75	70	1.56	40	15,000	103.4

## Metric Female Swivel Fitting

C9

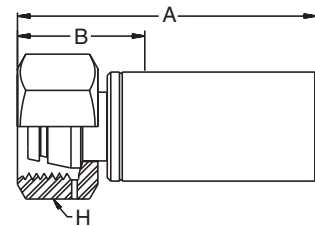

Part Number	Connection Type Thread Size	A Overall Length		B Cutoff Allowance		H Hex Size		Maximum Working Pressure	
		inch	mm	inch	mm	inch	mm	psi	MPa
#									
6C9LX-25-12C	M36 x 2	4.26	108	1.58	40	1.81	46	15,000	103.4

## JIC Female Swivel Fitting

06

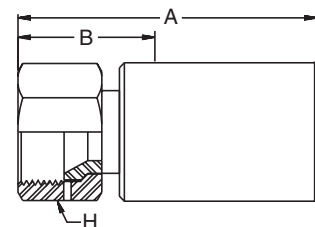

Part Number	Connection Type Thread Size	A Overall Length		B Cutoff Allowance		H Hex Size		Maximum Working Pressure	
		inch	mm	inch	mm	inch	mm	psi	MPa
#									
606LX-16-12C	1-5/16" - 12	4.29	109	1.68	43	1.50	38	10,000	69.0

## 2440N-16 **polyflex** Hose



Part Number	Jacket Color	Minimum I.D.		Maximum O.D.		Maximum Working Pressure		Minimum Burst Pressure		Minimum Bend Radius		Weight	
		inch	mm	inch	mm	psi	MPa	psi	MPa	inch	mm	lbs/ft	kg/m
#													
2440N-16V37	Gray	1.00	25	1.46	37	13,050	90.0	32,625	225.0	12.00	305	1.28	1.91
2440N-16V71	Black	1.00	25	1.46	37	13,050	90.0	32,625	225.0	12.00	305	1.28	1.91

**B**

**Construction:** Polyamide core tube, high strength wire reinforced and a polyamide outer cover.

**Temperature Range:** -40°F and +140°F (-40°C and +60°C). Contact **polyflex** for temperatures outside this range.

**Typical Applications:** Flexible, chemical resistant alternative to steel pipe for applications such as waterblasting, gas transfer, hydraulic workover and chemical injection. The -16V71 is typically used in Methanol injection applications.

## National Pipe Tapered (NPT) Male Fitting

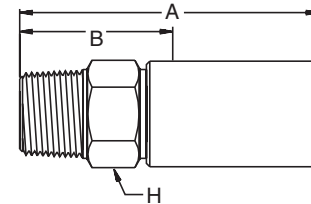

01

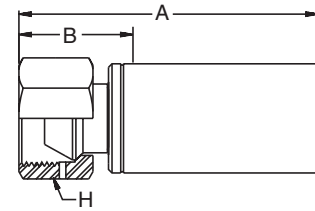

Part Number	Connection Type Thread Size	A Overall Length		B Cutoff Allowance		H Hex Size		Maximum Working Pressure	
		inch	mm	inch	mm	inch	mm	psi	MPa
#									
601LX-16-16C	1" NPT	5.00	125	2.50	64	1.38	35	10,000	69.0

## Type "M" Female Swivel Fitting AY

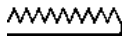



Part Number	Connection Type Thread Size	A Overall Length		B Cutoff Allowance		H Hex Size		Maximum Working Pressure	
		inch	mm	inch	mm	inch	mm	psi	MPa
#									
6AYLX-16-16C	1-5/16" - 12	5.45	139	2.04	52	1.50	38	13,050	90.0
6AYLX-16-16-HCL **	1-5/16" - 12	5.45	139	2.04	52	1.50	38	13,050	90.0
6AYLX-16-16C-SD *	1-5/16" - 12	5.45	139	2.04	52	1.50	38	13,050	90.0

\*\*HCL = For hydrochloric acid solutions up to 15% by mole

\*SD = Corrosion Resistant (seawater) — specially designed for aggressive fluids found in offshore drilling applications.

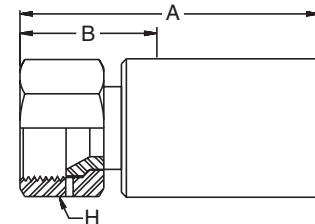
## JIC Female Swivel Fitting 06

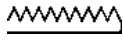

Part Number	Connection Type Thread Size	A Overall Length		B Cutoff Allowance		H Hex Size		Maximum Working Pressure	
		inch	mm	inch	mm	inch	mm	psi	MPa
#									
606LX-16-16C	1-5/16" - 12	3.79	96	1.65	42	1.5	38	10,000	69.0

## 2440N-32 **polyflex** Hose



Part Number	Jacket Color	Minimum I.D.		Maximum O.D.		Maximum Working Pressure		Minimum Burst Pressure		Minimum Bend Radius		Weight	
		inch	mm	inch	mm	psi	MPa	psi	MPa	inch	mm	lbs/ft	kg/m
#													
2440N-32V10	Black	2.00	51	2.71	69	5,000	34.5	20,000	137.9	20.00	508	3.50	5.22

**B**

**Construction:** Polyamide core tube, high strength wire reinforced and a polyurethane outer cover.

**Temperature Range:** -40°F and +140°F (-40°C and +60°C). Contact **polyflex** for temperatures outside this range.

**Typical Applications:** Flexible, chemical resistant alternative to steel pipe and multi-spiral 100R13 hoses for applications such as high volume flow rate pumping offshore, oilfield well service cementing, chemical injection and gas transfer. High pressure hydraulic applications with aggressive fluids, and as large flow waterblast delivery hose to multiple work stations.

## National Pipe Tapered (NPT) Male Fitting

01

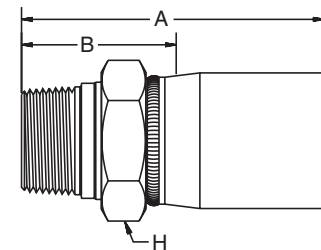

Part Number	Connection Type Thread Size	A Overall Length		B Cutoff Allowance		H Hex Size		Maximum Working Pressure	
		inch	mm	inch	mm	inch	mm	psi	MPa
#									
601LX-32-32	2" NPT	5.57	141	3.00	76	2.50	64	5,000	34.5

## JIC Female Swivel Fitting

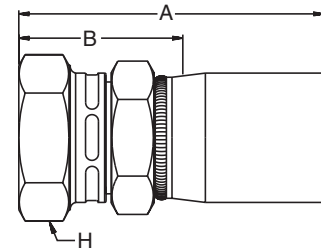

06

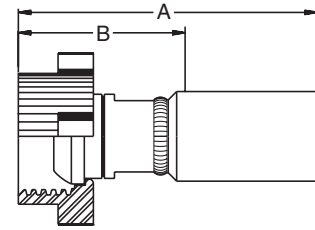

Part Number	Connection Type Thread Size	A Overall Length		B Cutoff Allowance		H Hex Size		Maximum Working Pressure	
		inch	mm	inch	mm	inch	mm	psi	MPa
#									
606LX-32-32	2-1/2 - 12	6.50	165	3.00	76	2.88	73	5,000	34.5

## 2" Hammer Union (Male) Cone with Wing Nut End Fitting AY

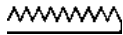



Part Number	Connection Type Thread Size	A Overall Length		B Cutoff Allowance		H Hex Size		Maximum Working Pressure	
		inch	mm	inch	mm	inch	mm	psi	MPa
#									
6AYLX-32-32-Flat	4-1/4" - 4 ACME	*	*	*	*	N/A	N/A	8,000	55.2

\*Call for information.

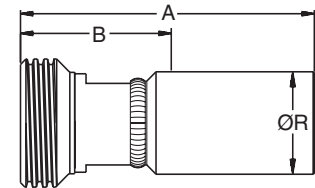
## 2" Hammer Union (Female) Cone, Threaded End with Seal YA



Part Number	Connection Type Thread Size	A Overall Length		B Cutoff Allowance		R Diameter		Maximum Working Pressure	
		inch	mm	inch	mm	inch	mm	psi	MPa
#									
6YALX-32-32	4-1/4" - 4 ACME	*	*	*	*	*	*	8,000	55.2

\*Call for information.



**2640D-025 polyflex Hose**



Part Number	Jacket Color	Minimum I.D.		Maximum O.D.		Maximum Working Pressure		Minimum Burst Pressure		Minimum Bend Radius		Weight	
		inch	mm	inch	mm	psi	MPa	psi	MPa	inch	mm	lbs/ft	kg/m
#													
2640D-025V32	Blue	0.16	4	0.48	12	40,600	280.0	101,500	700.0	5.50	140	0.20	0.30

**B**

**Construction:** Polyoxymethylene core tube, high strength wire reinforced and a polyamide outer cover.

**Temperature Range:** -40°F and +140°F (-40°C and +60°C). Contact **polyflex** for temperatures outside this range.

**Typical Applications:** Small diameter flexible hose, ideal for tight routing applications such as hydraulic tools, and high pressure heat exchanger tube cleaning in petrochemical and power plants. Especially suitable for hydraulic pre-tensioning equipment, specialized pressure fitted sleeve and coupling removal equipment. Pressure testing, operations of portable jacks and remote pressure sensing devices.

**Type 'M' Female Swivel Fitting**  
AY

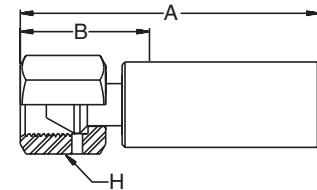

Part Number	Connection Type Thread Size	A Overall Length		B Cutoff Allowance		H Hex Size		Maximum Working Pressure	
		inch	mm	inch	mm	inch	mm	psi	MPa
#									
6AYHX-6-2AC	9/16" - 18	3.13	79	1.33	34	0.69	18	40,600	280.0

## High Pressure Tube Nipple Y4

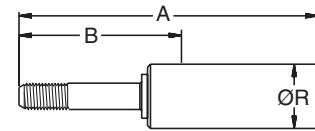

Part Number	Connection Type Thread Size	A Overall Length		B Cutoff Allowance		R Diameter		Maximum Working Pressure	
		inch	mm	inch	mm	inch	mm	psi	MPa
#									
6Y4HX-4-2AC	1/4" - 28 LH	3.50	89	1.75	44	0.68	17	40,600	280.0
6Y4HX-6-2AC	3/8" - 24 LH	3.95	100	2.20	56	0.68	17	40,600	280.0

## High Pressure Female Swivel Fitting 6Y

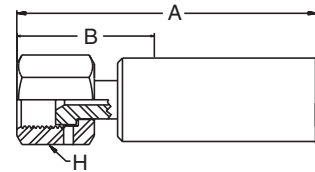

Part Number	Connection Type Thread Size	A Overall Length		B Cutoff Allowance		H Hex Size		Maximum Working Pressure	
		inch	mm	inch	mm	inch	mm	psi	MPa
#									
66YHX-4-2AC	9/16" - 18	3.13	79	1.33	34	0.69	18	40,600	280.0

## 2640D-03 **polyflex** Hose



Part Number	Jacket Color	Minimum I.D.		Maximum O.D.		Maximum Working Pressure		Minimum Burst Pressure		Minimum Bend Radius		Weight	
		inch	mm	inch	mm	psi	MPa	psi	MPa	inch	mm	lbs/ft	kg/m
#													
2640D-03V32	Blue	0.20	5	0.51	13	36,230	249.9	90,580	624.7	6.88	175	0.27	0.40

**B**

**Construction:** Polyoxymethylene core tube, high strength wire reinforced and a polyamide outer cover.

**Temperature Range:** -40°F and +140°F (-40°C and +60°C). Contact **polyflex** for temperatures outside this range.

**Typical Applications:** High pressure waterblast cleaning of heat exchanger tubes in petrochemical and power plants. Especially suitable for hydraulic pre-tensioning equipment and specialized pressure fitted sleeve and coupling removal equipment. Pressure testing, operations of portable jacks and remote pressure sensing devices.

## Type "M" Female Swivel Fitting AY

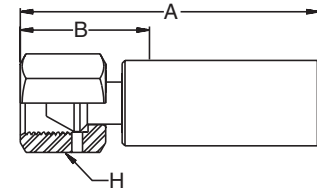

Part Number	Connection Type Thread Size	A Overall Length		B Cutoff Allowance		H Hex Size		Maximum Working Pressure	
		inch	mm	inch	mm	inch	mm	psi	MPa
#									
6AY5X-6-3	9/16" - 18	3.07	78	1.29	33	0.75	19	36,230	249.9
6AY5X-6-3C	9/16" - 18	3.10	79	1.43	36	0.69	18	36,230	249.9

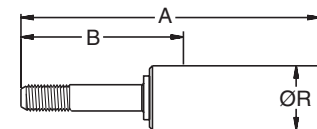

## High Pressure Tube Nipple Y4



Part Number	Connection Type Thread Size	A Overall Length		B Cutoff Allowance		R Diameter		Maximum Working Pressure	
		inch	mm	inch	mm	inch	mm	psi	MPa
#									
6Y45X-6-3C	3/8" - 24 LH	4.06	103	2.35	60	0.75	19	36,230	249.9
6Y45X-9-3C	9/16" - 18 LH	4.42	112	2.70	69	0.75	19	36,230	249.9

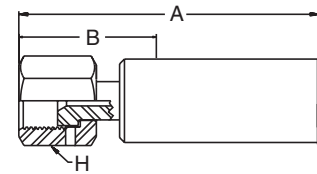

## High Pressure Female Swivel Fitting 6Y

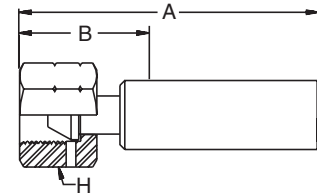

Part Number	Connection Type Thread Size	A Overall Length		B Cutoff Allowance		H Hex Size		Maximum Working Pressure	
		inch	mm	inch	mm	inch	mm	psi	MPa
#									
66Y5X-4-3	9/16" - 18	3.07	78	1.29	33	0.75	19	36,230	249.9
66Y5X-4-3C	9/16" - 18	3.10	79	1.43	36	0.69	18	36,230	249.9

## BSP Female Swivel Fitting 92

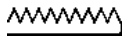

Part Number	Connection Type Thread Size	A Overall Length		B Cutoff Allowance		H Hex Size		Maximum Working Pressure	
		inch	mm	inch	mm	inch	mm	psi	MPa
#									
1925X-4-3	1/4" BSPP	3.07	78	1.26	32	0.87	22	36,230	249.9

## 2640N-08 **polyflex** Hose



Part Number	Jacket Color	Minimum I.D.		Maximum O.D.		Maximum Working Pressure		Minimum Burst Pressure		Minimum Bend Radius		Weight	
		inch	mm	inch	mm	psi	MPa	psi	MPa	inch	mm	lbs/ft	kg/m
#													
2640N-08V32	Blue	0.50	13	0.97	25	26,090	179.9	65,220	449.8	11.41	290	0.91	1.36

**B**

**Construction:** Polyamide core tube, high strength wire reinforced and a polyamide outer cover.

**Typical Applications:** Flexible, chemical resistant alternative to steel pipe delivery hose in waterblasting, hydrodemolition systems, chemical injection and gas transfer, oil field wireline logging services, and pressure testing.

**Temperature Range:** -40°F and +140°F (-40°C and +60°C). Contact **polyflex** for temperatures outside this range.

## Type "M" Female Swivel Fitting AY

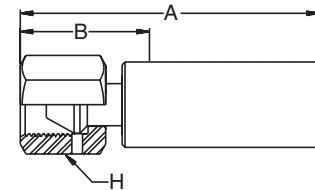

Part Number	Connection Type Thread Size	A Overall Length		B Cutoff Allowance		H Hex Size		Maximum Working Pressure	
		inch	mm	inch	mm	inch	mm	psi	MPa
#									
6AY5X-11-8C	1" - 12	4.25	108	1.72	44	1.25	32	26,090	179.9

## Medium Pressure Tube Nipple

Y2

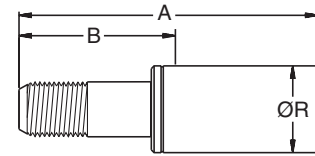

Part Number	Connection Type Thread Size	A Overall Length		B Cutoff Allowance		R Diameter		Maximum Working Pressure	
		inch	mm	inch	mm	inch	mm	psi	MPa
#									
6Y25X-9-8C	9/16" - 18 LH	4.30	109	2.19	56	1.25	32	20,000	137.9
6Y25X-12-8C	3/4" - 16 LH	4.20	107	2.10	53	1.25	32	20,000	137.9

## Metric Female Swivel Fitting

C9

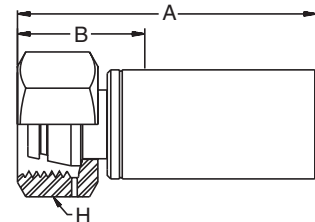

Part Number	Connection Type Thread Size	A Overall Length		B Cutoff Allowance		H Hex Size		Maximum Working Pressure	
		inch	mm	inch	mm	inch	mm	psi	MPa
#									
6C95X-16-8C	M24 x 1.5	3.58	91	1.45	37	1.26	32	20,000	137.9

## 2640N-12 **polyflex** Hose



Part Number	Jacket Color	Minimum I.D.		Maximum O.D.		Maximum Working Pressure		Minimum Burst Pressure		Minimum Bend Radius		Weight	
		inch	mm	inch	mm	psi	MPa	psi	MPa	inch	mm	lbs/ft	kg/m
#													
2640N-12V32	Blue	0.75	19	1.30	33	20,290	139.9	50,720	349.8	13.77	350	1.41	2.10
2640N-12V71	Blue	0.75	19	1.30	33	20,290	139.9	50,720	349.8	13.77	350	1.41	2.10

**B**

**Construction:** Polyamide core tube, high strength wire reinforced and a polyamide outer cover.

**Temperature Range:** -40°F and +140°F (-40°C and +60°C). Contact **polyflex** for temperatures outside this range.

**Typical Applications:** Flexible, chemical resistant alternative to steel pipe for waterblasting, hydrodemolition, gas transfer, oil field snubbing and hydraulic workover systems, and chemical injection service. The -12V71 is typically used in methanol injection applications.

## Type "M" Female Swivel Fitting AY

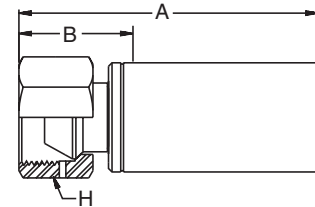

Part Number	Connection Type Thread Size	A Overall Length		B Cutoff Allowance		H Hex Size		Maximum Working Pressure	
		inch	mm	inch	mm	inch	mm	psi	MPa
#									
6AY5X-16-12C	1-5/16" - 12	4.26	108	1.52	39	1.50	38	20,290	139.9
6AY5X-16-12C-SD *	1-5/16" - 12	4.26	108	1.52	39	1.50	38	20,290	139.9

\*SD = Corrosion Resistant (sea water) — specially designed for aggressive fluids found in offshore drilling applications.

## Medium Pressure Tube Nipple

Y2

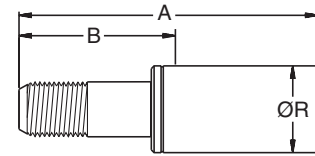

Part Number	Connection Type Thread Size	A Overall Length		B Cutoff Allowance		R Diameter		Maximum Working Pressure	
		inch	mm	inch	mm	inch	mm	psi	MPa
#									
6Y25X-16-12C	1" - 14 LH	5.48	139	2.75	70	1.69	43	20,000	137.9

## Metric Female Swivel Fitting

C9

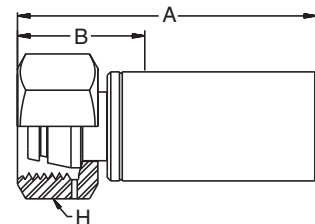

Part Number	Connection Type Thread Size	A Overall Length		B Cutoff Allowance		H Hex Size		Maximum Working Pressure	
		inch	mm	inch	mm	inch	mm	psi	MPa
#									
6C95X-25-12C	M36 x 2	4.37	111	1.60	41	1.81	46	15,000	103.4



## 2640N-32 **polyflex** Hose **Black Eagle** TC



Part Number	Jacket Color	Minimum I.D.		Maximum O.D.		Maximum Working Pressure		Minimum Burst Pressure		Minimum Bend Radius		Weight	
		inch	mm	inch	mm	psi	MPa	psi	MPa	inch	mm	lbs/ft	kg/m
#													
2640N-32V80	Black	2.00	51	3.30	84	10,000	69.0	26,100	180.0	32.00	813	5.70	8.49

**B**

**Construction:** Polyamide core tube, high strength wire reinforced and a polyurethane outer cover.

**Temperature Range:** -40°F and +140°F (-40°C and +60°C). Contact **polyflex** for temperatures outside this range.

**Typical Applications:** Flexible, chemical resistant alternative to steel pipe for high volume flow rate pumping offshore, oilfield well service cementing, chemical injection and gas transfer. For use in high pressure hydraulic systems, and as large volume waterblast delivery hose to distribution manifolds for multiple work stations.

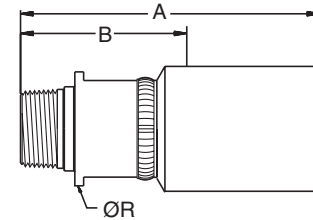

## National Pipe Tapered (NPT) Male Fitting 01



Part Number	Connection Type Thread Size	A Overall Length		B Cutoff Allowance		R Diameter		Maximum Working Pressure	
		inch	mm	inch	mm	inch	mm	psi	MPa
#									
6015X-32-32-TC	2" NPT	9.41	239	4.08	104	3.25	83	10,000	69.0

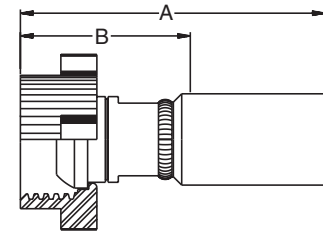

## 2" Hammer Union (Male) Cone with Wing Nut End Fitting HE

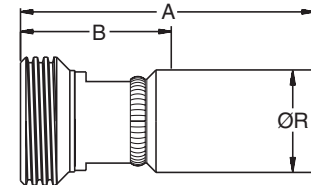

Part Number	Connection Type Thread Size	A Overall Length		B Cutoff Allowance		H Hex Size		Maximum Working Pressure	
		inch	mm	inch	mm	inch	mm	psi	MPa
#									
6HE5X-32-32-FLATTC	4-1/4" - 4 ACME	10.20	259	5.65	144	N/A	N/A	10,000	69.0

## 2" Hammer Union (Female) Cone, Threaded End with Seal HN



Part Number	Connection Type Thread Size	A Overall Length		B Cutoff Allowance		R Diameter		Maximum Working Pressure	
		inch	mm	inch	mm	inch	mm	psi	MPa
#									
6HN5X-32-32-TC	4-1/4" - 4 ACME	8.45	215	4.20	107	3.88	98	10,000	69.0

## 2740D-025 **polyflex** Hose



Part Number	Jacket Color	Minimum I.D.		Maximum O.D.		Maximum Working Pressure		Minimum Burst Pressure		Minimum Bend Radius		Weight	
		inch	mm	inch	mm	psi	MPa	psi	MPa	inch	mm	lbs/ft	kg/m
#													
2740D-025V30	Black	0.16	4	0.48	12	45,000	310.3	112,500	775.9	4.75	121	0.21	0.31

**B**

**Construction:** Polyoxymethylene core tube, high strength wire reinforced and a polyamide outer cover.

**Temperature Range:** -40°F and +140°F (-40°C and +60°C). Contact **polyflex** for temperatures outside this range.

**Typical Applications:** Small diameter flexible hose, ideal for tight routing applications such as hydraulic tools, and high pressure heat exchanger tube cleaning in petrochemical power plants. Especially suitable for hydraulic pre-tensioning equipment, specialized pressure fitted sleeve and coupling removal equipment. Pressure testing, operations of portable jacks and remote pressure sensing devices.

## Type "M" Female Swivel Fitting AY

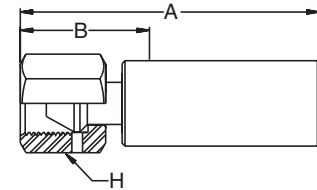

Part Number	Connection Type Thread Size	A Overall Length		B Cutoff Allowance		H Hex Size		Maximum Working Pressure	
		inch	mm	inch	mm	inch	mm	psi	MPa
#									
6AYHX-6-2AC	9/16"-18	3.13	79	1.33	34	0.69	18	45,000	310.3

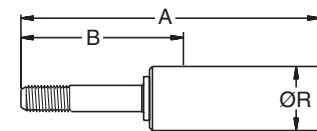

## High Pressure Tube Nipple Y4

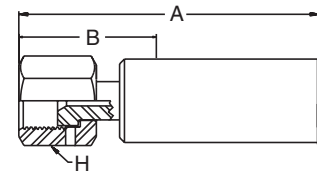

Part Number	Connection Type Thread Size	A Overall Length		B Cutoff Allowance		R Diameter		Maximum Working Pressure	
		inch	mm	inch	mm	inch	mm	psi	MPa
#									
6Y4HX-4-2AC	1/4"-28 LH	3.50	89	1.75	44	0.68	N/A	45,000	310.3
6Y4HX-6-2AC	3/8"-24 LH	3.95	100	2.20	56	0.68	N/A	45,000	310.3

# High Pressure Female Swivel Fitting 6Y

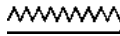

Part Number	Connection Type Thread Size	A Overall Length		B Cutoff Allowance		H Hex Size		Maximum Working Pressure	
		inch	mm	inch	mm	inch	mm	psi	MPa
#									
66YHX-4-2AC	9/16"-18	3.13	79	1.33	34	0.69	18	45,000	310.3

## 2740D-03 **polyflex** Hose



Part Number	Jacket Color	Minimum I.D.		Maximum O.D.		Maximum Working Pressure		Minimum Burst Pressure		Minimum Bend Radius		Weight	
		inch	mm	inch	mm	psi	MPa	psi	MPa	inch	mm	lbs/ft	kg/m
#													
2740D-03V30	Black	0.20	5	0.52	13	40,600	280.0	101,500	700.0	6.00	152	0.32	0.48

**B**

**Construction:** Polyoxymethylene core tube, high strength wire reinforced and a polyamide outer cover.

**Temperature Range:** -40°F and +140°F (-40°C and +60°C). Contact **polyflex** for temperatures outside this range.

**Typical Applications:** Pressure testing and ultra high pressure waterblast lances for high pressure tube cleaning in petrochemical and power plants. Replaces high pressure steel tubing where flexibility and long lengths are important to minimize leak points. Compression forming process (hydroforming) as a manufacturing procedure applying water pressure to produce complex hollow parts made from pipe-like materials for truck and automotive industries.

## Type "M" Female Swivel Fitting AY

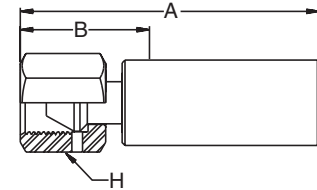

Part Number	Connection Type Thread Size	A Overall Length		B Cutoff Allowance		H Hex Size		Maximum Working Pressure	
		inch	mm	inch	mm	inch	mm	psi	MPa
#									
6AYHX-6-3C	9/16" - 18	3.20	81	1.40	36	0.68	17	40,600	280.0

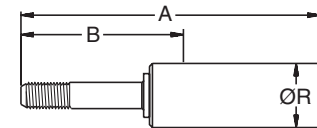

## High Pressure Tube Nipple Y4



Part Number	Connection Type Thread Size	A Overall Length		B Cutoff Allowance		R Diameter		Maximum Working Pressure	
		inch	mm	inch	mm	inch	mm	psi	MPa
#									
6Y4HX-6-3C	3/8" - 24 LH	4.05	103	2.36	60	0.82	21	40,600	280.0
6Y4HX-9-3C	9/16" - 18 LH	4.42	112	2.70	69	0.82	21	40,600	280.0

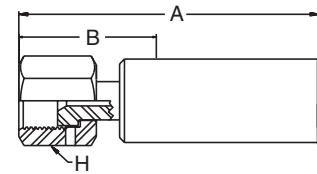

## High Pressure Female Swivel Fitting 6Y

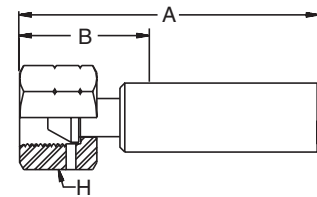

Part Number	Connection Type Thread Size	A Overall Length		B Cutoff Allowance		H Hex Size		Maximum Working Pressure	
		inch	mm	inch	mm	inch	mm	psi	MPa
#									
66YHX-4-3C	91/6" - 18	3.20	81	1.40	36	0.68	17	40,600	280.0

## BSP Female Swivel Fitting 92



Part Number	Connection Type Thread Size	A Overall Length		B Cutoff Allowance		H Hex Size		Maximum Working Pressure	
		inch	mm	inch	mm	inch	mm	psi	MPa
#									
692HX-4-3C	1/4" BSPP	3.07	78	1.28	33	0.87	22	40,600	280.0

## 2740D-05 **polyflex** Hose



Part Number	Jacket Color	Minimum I.D.		Maximum O.D.		Maximum Working Pressure		Minimum Burst Pressure		Minimum Bend Radius		Weight	
		inch	mm	inch	mm	psi	MPa	psi	MPa	inch	mm	lbs/ft	kg/m
#													
2740D-05V32	Blue	0.32	8	0.67	17	36,230	249.9	90,580	624.7	7.87	200	0.47	0.70

**B**

**Construction:** Polyoxymethylene core tube, high strength wire reinforced and a polyamide outer cover.

**Temperature Range:** -40°F and +140°F (-40°C and +60°C). Contact **polyflex** for temperatures outside this range.

**Typical Applications:** Pressure testing and ultra high pressure waterblast delivery hose for industrial cleaning and shipbuilding industries for coatings removal and water jet cutting equipment.

## Type "M" Female Swivel Fitting AY

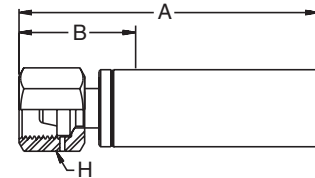

Part Number	Connection Type Thread Size	A Overall Length		B Cutoff Allowance		H Hex Size		Maximum Working Pressure	
		inch	mm	inch	mm	inch	mm	psi	MPa
#									
6AYHX-8-5C	3/4" - 16	2.97	75	1.24	31	1.00	25	36,230	249.9
6AYHX-10-5C	7/8" - 14	3.47	88	1.83	46	1.25	32	36,230	249.9
6AYHX-13-5C	1-1/8" - 12	3.70	94	2.08	53	1.38	35	36,230	249.9

## High Pressure Tube Nipple Y4

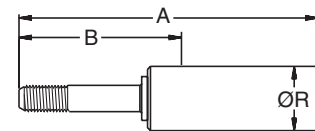

Part Number	Connection Type Thread Size	A Overall Length		B Cutoff Allowance		R Diameter		Maximum Working Pressure	
		inch	mm	inch	mm	inch	mm	psi	MPa
#									
6Y4HX-9-5C	9/16" - 18 LH	4.15	105	2.53	64	1.00	25	36,230	249.9
6Y4HX-9-5C-XLT	9/16" - 18 LH (Long Tube)	5.00	127	3.38	86	1.00	25	36,230	249.9

## 2840D-03 **polyflex** Hose



Part Number	Jacket Color	Minimum I.D.		Maximum O.D.		Maximum Working Pressure		Minimum Burst Pressure		Minimum Bend Radius		Weight	
		inch	mm	inch	mm	psi	MPa	psi	MPa	inch	mm	lbs/ft	kg/m
#													
2840D-03V34	Red	0.20	5	0.57	14	48,000	331.0	120,000	827.6	7.87	200	0.37	0.55
2840D-03V34 *	Red	0.20	5	1.57	40	* 60,000	413.8	120,000	827.6	7.87	200	1.23	1.83

\*With Pressure Containment Shield

**Construction:** Polyoxymethylene core tube, high strength wire reinforced and a polyamide outer cover.

**Temperature Range:** -40°F and +140°F (-40°C and +60°C). Contact **polyflex** for temperatures outside this range.

**Typical Applications:** Ultra high pressure hose used with robotic controlled Waterjet cutting equipment, and coatings removal from marine vessels near or at shipbuilding facilities. Replaces high pressure steel tubing where flexibility and long lengths are important to minimize leak points. Compression forming process (hydroforming) as a manufacturing procedure applying water pressure to produce complex hollow parts made from pipe-like materials for truck and automotive industries.

## High Pressure Tube Nipple

Y4

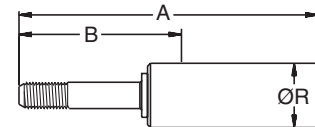

Part Number	Connection Type Thread Size	A Overall Length		B Cutoff Allowance		R Diameter		Maximum Working Pressure	
		inch	mm	inch	mm	inch	mm	psi	MPa
#									
6Y4WX-6-3C	3/8" - 24 LH	4.30	109	2.35	60	0.88	22	60,000	413.8
6Y4WX-9-3C	9/16" - 18 LH	4.42	112	2.50	64	0.88	22	60,000	413.8



## 2840D-05 **polyflex** Hose



Part Number	Jacket Color	Minimum I.D.		Maximum O.D.		Maximum Working Pressure		Minimum Burst Pressure		Minimum Bend Radius		Weight	
		inch	mm	inch	mm	psi	MPa	psi	MPa	inch	mm	lbs/ft	kg/m
#													
2840D-05V32	Blue	0.32	8	0.76	19	40,580	279.9	101,450	699.7	9.84	250	0.74	1.10

**B**

**Construction:** Polyoxymethylene core tube, high strength wire reinforced and a polyamide outer cover.

**Temperature Range:** -40°F and +140°F (-40°C and +60°C). Contact **polyflex** for temperatures outside this range.

**Typical Applications:** Ultra high pressure water jet cutting with robotic controlled waterjet cutting equipment, and coatings removal from marine vessels near or at shipbuilding facilities. Replaces high pressure steel tubing where flexibility and long continuous lengths are very important for high volume flow requirements, and to minimize leak points. Compression forming process (hydroforming) as a manufacturing procedure applying water pressure to produce complex hollow parts made from pipe-like materials for truck and automotive industries.

## Type "M" Female Swivel Fitting AY

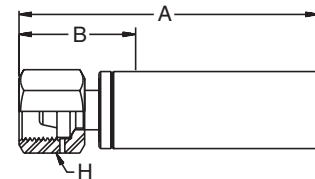

Part Number	Connection Type Thread Size	A Overall Length		B Cutoff Allowance		H Hex Size		Maximum Working Pressure	
		inch	mm	inch	mm	inch	mm	psi	MPa
#									
6AYWX-10-5C	7/8" - 14	4.43	113	1.77	45	1.25	32	40,580	279.9
6AYWX-13-5C	1-1/8" - 12	4.66	118	2.00	51	1.38	35	40,580	279.9

## High Pressure Tube Nipple Y4

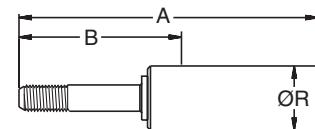

Part Number	Connection Type Thread Size	A Overall Length		B Cutoff Allowance		R Diameter		Maximum Working Pressure	
		inch	mm	inch	mm	inch	mm	psi	MPa
#									
6Y4WX-9-5C	9/16" - 18 LH	5.13	130	2.47	63	1.10	28	40,580	279.9
6Y4WX-9-5C-RCS	9/16" - 18 LH (Long Tube)	5.73	146	3.07	78	1.10	28	40,580	279.9

## 2840D-08 **polyflex** Hose



Part Number	Jacket Color	Minimum I.D.		Maximum O.D.		Maximum Working Pressure		Minimum Burst Pressure		Minimum Bend Radius		Weight	
		inch	mm	inch	mm	psi	MPa	psi	MPa	inch	mm	lbs/ft	kg/m
#													
2840D-08V30	Black	0.50	13	1.16	29	36,000	248.3	90,000	620.7	*	*	*	*

\*Call for information.

**Construction:** Polyoxymethylene core tube, high strength wire reinforced and a polyamide outer cover.

**Temperature Range:** -40°F and +140°F (-40°C and +60°C). Contact **polyflex** for temperatures outside this range.

**Typical Applications:** Ultra high pressure waterblast delivery hose and high pressure coatings removal. Replaces high pressure steel tubing where flexibility and long single lengths are important to minimize leak points for water jet cutting equipment.

## High Pressure Tube Nipple YM

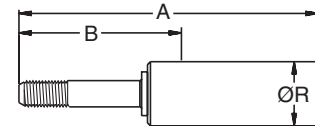

Part Number	Connection Type Thread Size	A Overall Length		B Cutoff Allowance		R Diameter		Maximum Working Pressure	
		inch	mm	inch	mm	inch	mm	psi	MPa
#									
6Y4WX-16-08C	1" - 12 LH	*	*	*	*	*	*	30,000	206.9

\*Call for information.

## 2X90N-04 **polyflex** Hose



Part Number	Jacket Color	Minimum I.D.		Maximum O.D.		Maximum Working Pressure with 2.5:1 Safety Factor		Maximum Working Pressure with 4:1 Safety Factor		Minimum Burst Pressure		Minimum Bend Radius		Weight	
		inch	mm	inch	mm	psi	MPa	psi	MPa	psi	MPa	inch	mm	lbs/ft	kg/m
#															
2X90N-04V14	Red	0.25	6	0.53	13	18,560	128.0	11,600	80.0	46,400	320.0	1.57	40	0.19	0.28

**B**

**Construction:** Polyamide core tube, steel wire and fiber combination reinforcement with a polyurethane outer cover.

**Temperature Range:** -40°F and +140°F (-40°C and +60°C). Contact **polyflex** for temperatures outside this range.

**Typical Applications:** Flexible, lightweight, chemical resistant alternative to rubber hose for waterblast cleaning applications in pulp and paper mills, steel mills, power plants and petrochemical plants. Available in long lengths.

## National Pipe Tapered (NPT) Male Fitting 01

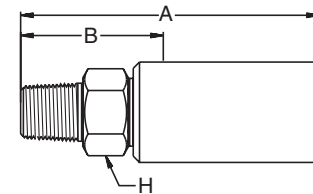

Part Number	Connection Type Thread Size	A Overall Length		B Cutoff Allowance		H Hex Size		Maximum Working Pressure	
		inch	mm	inch	mm	inch	mm	psi	MPa
#									
1018X-6-4	3/8" NPT	2.72	69	1.47	37	0.75	19	15,000	103.4
6018X-4-4	1/4" NPT	2.62	67	1.37	35	0.63	16	15,000	103.4
601LX-4-4C	1/4" NPT	2.62	67	1.37	35	0.63	16	15,000	103.4

## Type "M" Female Swivel Fitting AY

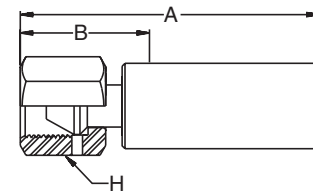

Part Number	Connection Type Thread Size	A Overall Length		B Cutoff Allowance		H Hex Size		Maximum Working Pressure	
		inch	mm	inch	mm	inch	mm	psi	MPa
#									
6AY8X-6-4	9/16" - 18	2.54	65	1.30	33	0.75	19	16,240	112.0
6AYLX-6-4C	9/16" - 18	2.69	68	1.39	35	0.68	17	16,240	112.0
6AYLX-6-4C-SD *	9/16" - 18	2.54	65	1.30	33	0.75	19	16,240	112.0

\*SD – Corrosion resistant (sea water)

## JIC Female Swivel Fitting

06

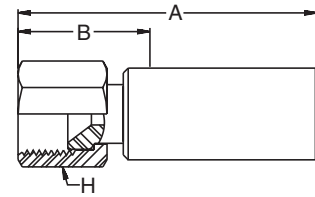

Part Number	Connection Type Thread Size	A Overall Length		B Cutoff Allowance		H Hex Size		Maximum Working Pressure	
		inch	mm	inch	mm	inch	mm	psi	MPa
#									
1068X-4-4	7/16" - 20	2.64	67	1.37	35	0.75	19	10,000	69.0
1068X-6-4	9/16" - 18	2.58	66	1.30	33	0.75	19	10,000	69.0
6069X-4-4C	7/16" - 20	2.24	57	0.98	25	0.63	16	10,000	69.0
6069X-6-4C	9/16" - 18	2.36	60	1.10	28	0.68	17	10,000	69.0

## Medium Pressure Female Swivel Fitting

5Y

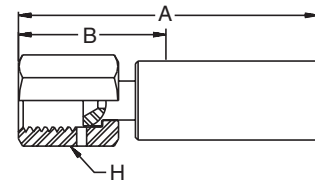

Part Number	Connection Type Thread Size	A Overall Length		B Cutoff Allowance		H Hex Size		Maximum Working Pressure	
		inch	mm	inch	mm	inch	mm	psi	MPa
#									
65Y8X-6-4	9/16" - 18	2.78	71	1.55	39	0.75	19	16,240	112.0
65YLX-6-4C	9/16" - 18	2.84	72	1.54	39	0.75	19	16,240	112.0

## BSP Female Swivel Fitting

92

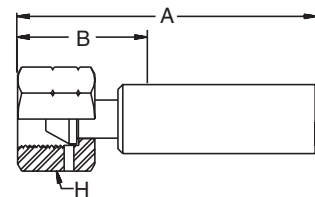

Part Number	Connection Type Thread Size	A Overall Length		B Cutoff Allowance		H Hex Size		Maximum Working Pressure	
		inch	mm	inch	mm	inch	mm	psi	MPa
#									
6928X-4-4	1/4" BSPP	2.51	64	1.27	32	0.75	19	16,240	112.0

## BSP Male Fitting

D9

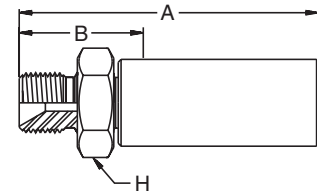

Part Number	Connection Type Thread Size	A Overall Length		B Cutoff Allowance		H Hex Size		Maximum Working Pressure	
		inch	mm	inch	mm	inch	mm	psi	MPa
#									
1D98X-4-4	1/4" BSPP	2.65	67	1.39	35	0.75	19	16,240	112.0

**B**

## Male Stecko Fitting

MB

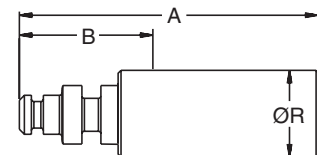

Part Number	Connection Type Thread Size	A Overall Length		B Cutoff Allowance		R Diameter		Maximum Working Pressure	
		inch	mm	inch	mm	inch	mm	psi	MPa
#									
1MB8X-6-4	None	2.85	72	1.58	40	0.86	22	10,000	69.0

## Metric Female Swivel Fitting

C3

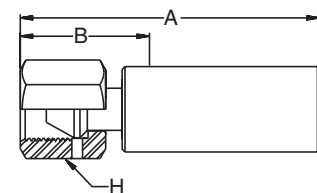

Part Number	Connection Type Thread Size	A Overall Length		B Cutoff Allowance		H Hex Size		Maximum Working Pressure	
		inch	mm	inch	mm	inch	mm	psi	MPa
#									
1C38X-4-4	M14 x 1.5	2.45	62	1.20	30	0.75	19	16,240	112.0

## 2X90N-06 **polyflex** Hose



Part Number	Jacket Color	Minimum I.D.		Maximum O.D.		Maximum Working Pressure with 2.5:1 Safety Factor		Maximum Working Pressure with 4:1 Safety Factor		Minimum Burst Pressure		Minimum Bend Radius		Weight	
		inch	mm	inch	mm	psi	MPa	psi	MPa	psi	MPa	inch	mm	lbs/ft	kg/m
#															
2X90N-06V14	Red	0.40	10	0.85	22	23,200	160.0	15,000	103.4	58,000	400.0	3.75	95	0.63	0.94

**Construction:** Polyamide core tube, steel wire and fiber combination reinforcement with a polyurethane outer cover.

**Temperature Range:** -40°F and +140°F (-40°C and +60°C). Contact **polyflex** for temperatures outside this range.

**Typical Applications:** Flexible, lightweight, chemical resistant alternative to rubber hose for waterblast cleaning applications in pulp and paper mills, steel mills, power plants and petrochemical plants. Available in long lengths.

## National Pipe Tapered (NPT) Male Fitting 01

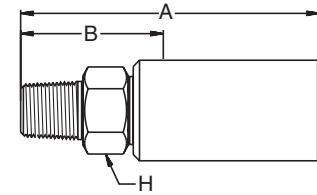

Part Number	Connection Type Thread Size	A Overall Length		B Cutoff Allowance		H Hex Size		Maximum Working Pressure	
		inch	mm	inch	mm	inch	mm	psi	MPa
#									
601RS-6-6	3/8" NPT	3.3	84	1.77	45	0.75	19	15,000	103.4

## Metric Female Swivel Fitting C3

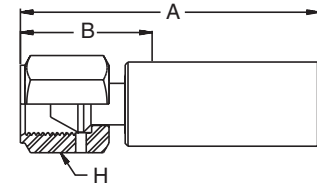

Part Number	Connection Type Thread Size	A Overall Length		B Cutoff Allowance		H Hex Size		Maximum Working Pressure	
		inch	mm	inch	mm	inch	mm	psi	MPa
#									
6C9RS-14-5	M22x1.5	3.3	84	1.77	45	1	25	23,200	160.0

**2X90N-08 polyflex Hose**  
“Red Snake”



Part Number	Jacket Color	Minimum I.D.		Maximum O.D.		Maximum Working Pressure with 2.5:1 Safety Factor		Maximum Working Pressure with 4:1 Safety Factor		Minimum Burst Pressure		Minimum Bend Radius		Weight	
		inch	mm	inch	mm	psi	MPa	psi	MPa	psi	MPa	inch	mm	lbs/ft	kg/m
#															
2X90N-08V14	Red	0.50	13	0.91	23	15,080	104.0	9,425	65.0	37,700	260.0	3.15	80	0.45	0.67

**B**

**Construction:** Polyamide core tube, steel wire and fiber combination reinforcement with a polyurethane outer cover.

**Temperature Range:** -40°F and +140°F (-40°C and +60°C). Contact **polyflex** for temperatures outside this range.

**Typical Applications:** Flexible, lightweight, chemical resistant alternative to rubber hose for waterblast cleaning applications in pulp and paper mills, steel mills, power plants and petrochemical plants. Available in long lengths.

**National Pipe Tapered (NPT) Male Fitting**  
01

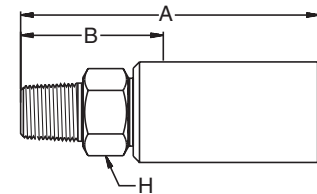

Part Number	Connection Type Thread Size	A Overall Length		B Cutoff Allowance		H Hex Size		Maximum Working Pressure	
		inch	mm	inch	mm	inch	mm	psi	MPa
#									
101RS-8-08	1/2" NPT	3.68	93	1.45	37	0.87	22	15,000	103.4

**Metric Female Swivel Fitting**  
C9

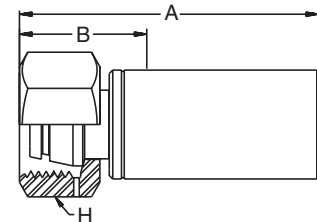

Part Number	Connection Type Thread Size	A Overall Length		B Cutoff Allowance		H Hex Size		Maximum Working Pressure	
		inch	mm	inch	mm	inch	mm	psi	MPa
#									
1C9RS-16-08	M24 x 1.5	3.55	90	1.45	37	1.26	32	15,000	103.4

## 57CR **polyflex** Hose

Collapse Resistant

High Pressure

U.S. Patent 6,390,141

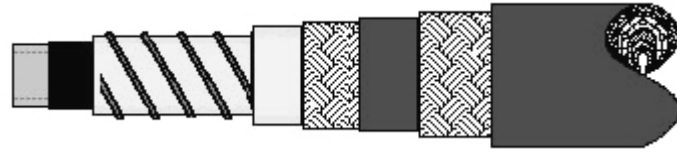

Part Number	Jacket Color	Nominal I.D.		Nominal O.D.		Maximum Working Pressure		Maximum Elongation @ Working Pressure	Minimum Burst Pressure		Minimum Bend Radius		Weight	
		inch	mm	inch	mm	psi	MPa	psi	psi	MPa	inch	mm	lbs/ft	kg/m
57CR-6	Blue	0.38	10	1.09	28	5,000	34.5	0 to +4%	20,000	137.9	5.00	127	0.503	0.748
57CR-8	Blue	0.50	13	1.18	30	5,000	34.5	0 to +4%	20,000	137.9	6.25	159	0.630	0.937
57CR-16	Blue	1.00	25	2.00	51	5,000	34.5	0 to +4%	20,000	137.9	10.75	273	1.460	2.170

\*Rating for hose in maximum water depth exposure based on limited laboratory testing.

Internal impulse requirement: SAE J343; Minimum of 150,000 cycles at 140°F (+60°C) and 5,000 psi (34.5 MPa)

**Scope:** Specification HS-57CR details the performance of collapse resistant hose for use with high internal pressures. The hose is best suited for offshore oil exploration applications requiring internal pressure resistance and external pressure support. The 57CR series hose offers the ultimate in a lightweight, kink and collapse resistant rugged hose construction.

**Construction:** The 57CR consists of a polyamide core tube, reinforced with high-tensile strength aramid fiber, and a Patent-Pending stainless steel reinforced helix support. The hose is jacketed, as standard, with a weather and ultra-high abrasion resistant, non-perforated polymeric jacket. The hose suitable for marine hydraulic (salt water) environment.

**Typical Applications:** Offshore oilfield exploration and production. For use with petroleum, synthetic hydraulic oils, water and water based hydraulic fluids. Hose is not recommended for high pressure pneumatic service applications.

**Temperature Range:** -40°F and +140°F (-40°C and +60°C). Contact **polyflex** for temperatures outside this range.

**Color:** Standard is blue. Other colors available upon request.

## JIC Female Swivel Fitting

06

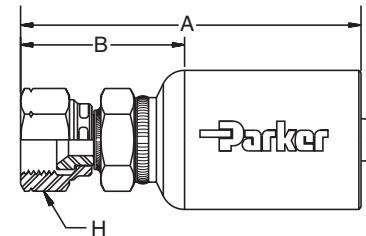

Part Number	Connection Type Thread Size	A Overall Length		B Cutoff Allowance		H Hex Size		Maximum Working Pressure	
		inch	mm	inch	mm	inch	mm	psi	MPa
606CR-6-6C	9/16" - 18	3.125	79	1.875	48	0.750	19	5,000	34.5
606CR-8-8C	3/4" - 16	3.875	98	2.125	54	1.000	25	5,000	34.5
606CR-16-16C	1-5/16" - 12	5.000	127	2.750	70	1.625	41	5,000	34.5



# HP® – High Pressure Hose

## HP8® – High Pressure Non-Conductive Hose

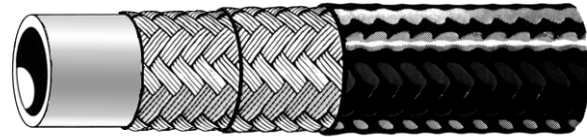

Part No.	Jacket Color	Minimum I.D.		Maximum O.D.		Maximum Working Pressure		Minimum Burst Pressure		Minimum Bend Radius		Weight		Typ. Volume Expansion at Working Pressure		Guard Kit Part Number 12 in.	Guard Kit Part Number 23 in.	Crimp Fitting Series
		inch	m	inch	m	psi	MPa	psi	MPa	inch	m	lbs/ft	kg/m	cc/ft.	cc/m			
#																#	#	
HP-3	Blue	0.19	5	0.52	13	10000	69.0	40000	275.9	1.50	38	.09	0.13	2.4	7.87	HPG3-12K	HPG3-23K	HP
HP-4	Blue	0.25	6	0.60	15	10000	69.0	40000	275.9	2.50	64	.11	0.16	3.3	10.83	HPG4-12K	HPG4-23K	HP
HP-6	Blue	0.38	10	0.74	19	8000	55.2	32000	220.7	3.00	76	.16	0.23	4.6	15.09	HPG6-12K	HPG6-23K	HP
HP8-3	Orange	0.19	5	0.52	13	10000	69.0	40000	275.9	1.50	38	.09	0.13	2.4	7.87	HPG3-12K-ORG	HPG3-23K-ORG	HP
HP8-4	Orange	0.25	6	0.60	15	10000	69.0	40000	275.9	2.50	64	.11	0.16	3.3	10.83	HPG4-12K-ORG	HPG4-23K-ORG	HP
HP8-6	Orange	0.38	10	0.74	19	8000	55.2	32000	220.7	3.00	76	.16	0.23	4.6	15.09	HPG6-12K-ORG	HPG6-23K-ORG	HP

**B**

Meets or exceeds SAE J517 for less than 50 microamps leakage under 75000 volts per foot.

**Construction:** Specially formulated thermoplastic elastomer core tube, high tensile strength aramid fiber reinforcement. HP8 Hose has an orange non-perforated elastomeric cover.

**Applications:** High pressure hydraulic, pneumatic and lubricating oils including high pressure tools, rigging jacks, test apparatus, oilfield pressure control devices and offshore oil applications. Non-conductive version used in aerial lift equipment. Not recommended for water blast applications or for use in static discharge applications; i.e., airless paint spray.

**Note:** The above hose(s) are not intended for use in static discharge applications; i.e., airless paint spray.

**Temperature Range:** -40°F to +150°F (-40°C to +66°C) for petroleum or synthetic hydraulic fluids, water base fluids and compatible chemicals.

**Hose Guards:** See page B110.

**Fitting Series:** HP Series. Field attachable crimp fittings with prior divisional certification.

Refer to HP Hose Assembly Instructions Bulletin No. 4660-B45.

## National Pipe Tapered (NPT) Male Fitting

01

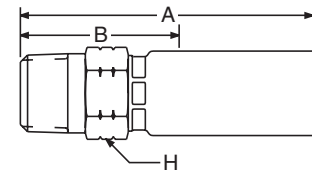

Steel Part No.	NPTF Thread Size	Minimum I.D.		A Overall Length		B Cutoff Allowance		H Hex Size		Pusher Number	Swage Die	Crimp Die
		inch	mm	inch	mm	inch	mm	inch	mm			
#										#		
101HP-2-3	1/8-27	0.19	5	1.94	49	1.19	30	0.56	14	PUM 001	HP3	80C-HP3
101HP-2-4	1/8-27	0.25	6	2.10	53	1.19	30	0.63	16	PUM 002	HP4	80C-HP4
101HP-4-3	1/4-18	0.19	5	2.12	54	1.38	35	0.69	17	PUM 004	HP3	80C-HP3
101HP-4-4	1/4-18	0.25	6	2.28	58	1.38	35	0.69	17	PUM 004	HP4	80C-HP4
101HP-4-6	1/4-18	0.38	10	2.70	69	1.50	38	0.75	19	PUM 005	HP6	80C-HP6
101HP-6-3	3/8-18	0.19	5	2.22	56	1.50	38	0.75	19	PUM 005	HP3	80C-HP3
101HP-6-4	3/8-18	0.25	6	2.38	60	1.38	35	0.75	19	PUM 005	HP4	80C-HP4
101HP-6-6	3/8-18	0.38	10	2.70	69	1.50	38	0.75	19	PUM 005	HP6	80C-HP6
101HP-8-6	1/2-14	0.38	10	2.96	75	1.75	44	0.94	24	PUM 009	HP6	80C-HP6

Note: Some versions of HP Fittings may not allow for use of swage dies. Care should be taken to assure proper use. Consult factory with questions.

## JIC Female Swivel Fitting

06

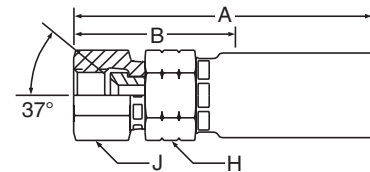

Steel Part No.	NPTF Thread Size	Minimum I.D.		A Overall Length		B Cutoff Allowance		H Hex Size		J Hex Size		Pusher Number	Swage Die	Crimp Die
		inch	mm	inch	mm	inch	mm	inch	mm	inch	mm			
#												#		
106HP-4-3	7/16-20	0.19	5	2.20	56	1.44	37	0.63	16	0.63	16	PUF 011	HP3	80C-HP3
106HP-4-4	7/16-20	0.25	6	2.49	63	1.56	40	0.63	16	0.63	16	PUF 010	HP4	80C-HP4
106HP-5-4	1/2-20	0.25	6	2.52	64	1.56	40	0.75	19	0.75	19	PUF 013	HP4	80C-HP4
106HP-6-4	9/16-18	0.25	6	2.59	66	1.69	43	0.75	19	0.75	19	PUF 015	HP4	80C-HP4
106HP-6-6	9/16-18	0.38	10	2.91	74	1.63	41	0.75	19	0.75	19	PUF 015	HP6	80C-HP6

Note: Some versions of HP Fittings may not allow for use of swage dies. Care should be taken to assure proper use. Consult factory with questions.

## High Pressure Safety Guard Kit

Use with Parker HP or HP8 hose only. Each guard kit contains two color coded, pre-assembled 12" or 23" guards, a color coded warning tag, and complete assembly instructions. Use blue guards with HP hose and orange guards with HP8 hose.

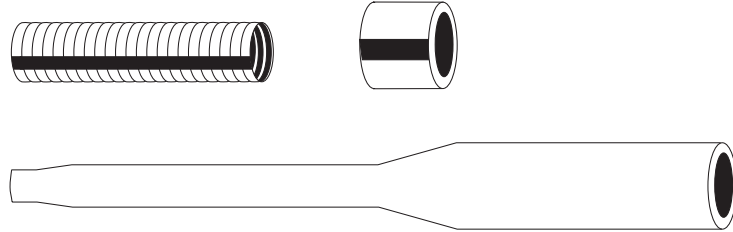

**B**

Blue Guard Kit Part Number**	Orange Guard Kit Part Number*	Hose Size	Weight Per Guard lbs.	Crimp Die Part Number
#	#			
HPG3-12K	HPG3-12K-ORG	-3	0.27	80C-G03
HPG3-23K	HPG3-23K-ORG	-3	0.37	80C-G03
HPG4-12K	HPG4-12K-ORG	-4	0.32	80C-G04
HPG4-23K	HPG4-23K-ORG	-4	0.42	80C-G04
HPG6-12K	HPG6-12K-ORG	-6	0.40	80C-G06
HPG6-23K	HPG6-23K-ORG	-6	0.52	80C-G06

\* For HP8 hose

\*\* For HP hose

## 2245N-04-D Twin Line **polyflex** Hose

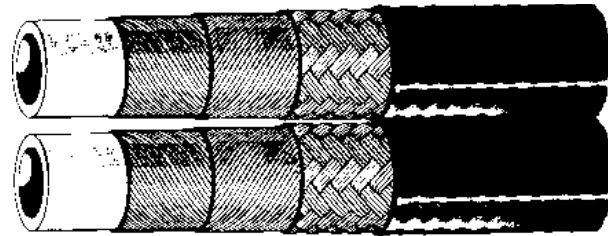

Part Number	Jacket Color	Minimum I.D.		Maximum O.D.		Maximum Working Pressure with 2.5:1 Safety Factor		Maximum Working Pressure with 4:1 Safety Factor		Minimum Burst Pressure		Minimum Bend Radius		Weight	
		inch	mm	inch	mm	psi	MPa	psi	MPa	psi	MPa	inch	mm	lbs/ft	kg/m
#															
2245N-04V00	Black	0.25	6	0.50	13	10,440	72.0	6,525	45.0	26,100	180.0	2.76	70	0.17	0.25
2245N-04V02	Blue	0.25	6	0.50	13	10,440	72.0	6,525	45.0	26,100	180.0	2.76	70	0.17	0.25
2245N-04V04	Red	0.25	6	0.50	13	10,440	72.0	6,525	45.0	26,100	180.0	2.76	70	0.17	0.25

**Construction:** Polyamide core tube, high strength wire reinforced and a polyurethane outer cover.

**Typical Applications:** Industrial equipment, rescue equipment, hydraulic tools.

Assembly includes any combination of two hoses (mix or match 2245N-04-D and 2380N-04-D) with any fitting listed for that hose.

## National Pipe Tapered (NPT) Male Fitting 01

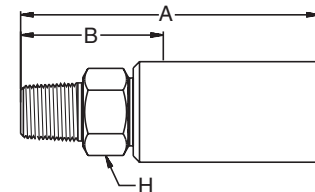

Part Number	Connection Type Thread Size	A Overall Length		B Cutoff Allowance		H Hex Size/ R Diameter		Maximum Working Pressure	
		inch	mm	inch	mm	inch	mm	psi	MPa
#									
101NX-4-4	1/4" NPT	2.57	65	1.35	34	0.63	16	10,400	71.7
101NX-6-4	3/8" NPT	2.63	67	1.38	35	0.75	19	10,400	71.7
601NX-4-4C	1/4" NPT	2.38	60	1.12	28	0.63	16	10,400	71.7

## Type "M" Female Swivel Fitting AY

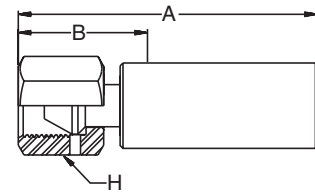

Part Number	Connection Type Thread Size	A Overall Length		B Cutoff Allowance		H Hex Size		Maximum Working Pressure	
		inch	mm	inch	mm	inch	mm	psi	MPa
#									
6AYNX-6-4	9/16" - 18	2.56	65	1.32	34	0.75	19	10,440	72.0
6AYNX-6-4C	9/16" - 18	2.36	60	1.11	28	0.68	17	10,440	72.0

**B**

## JIC Female Swivel Fitting 06

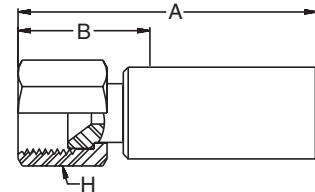

Part Number	Connection Type Thread Size	A Overall Length		B Cutoff Allowance		H Hex Size		Maximum Working Pressure	
		inch	mm	inch	mm	inch	mm	psi	MPa
#									
106NX-4-4	7/16" - 20	2.56	65	1.37	35	0.75	19	10,000	69.0
106NX-6-4	9/16" - 18	2.56	65	1.32	34	0.75	19	10,000	69.0
606NX-4-4C	7/16" - 20	2.23	57	0.99	25	0.63	16	10,000	69.0
606NX-6-4C	9/16" - 18	2.36	60	1.11	28	0.68	17	10,000	69.0

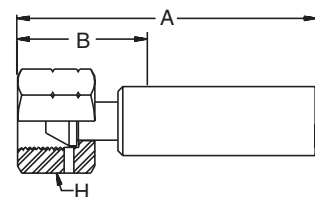

## BSP Female Swivel Fitting BC



Part Number	Connection Type Thread Size	A Overall Length		B Cutoff Allowance		H Hex Size		Maximum Working Pressure	
		inch	mm	inch	mm	inch	mm	psi	MPa
#									
1BCNX-4-4	1/4" BSPP	2.50	64	1.25	32	0.75	19	10,440	72.0

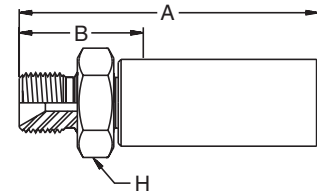

## BSP Male Fitting D9

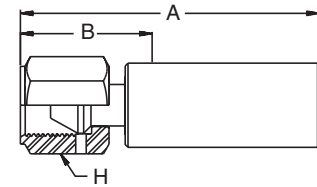

Part Number	Connection Type Thread Size	A Overall Length		B Cutoff Allowance		H Hex Size		Maximum Working Pressure	
		inch	mm	inch	mm	inch	mm	psi	MPa
#									
1D9NX-4-4	1/4" BSPP	2.64	67	1.40	36	0.75	19	10,440	72.0

## Metric Female Swivel Fitting C3

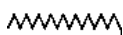

Part Number	Connection Type Thread Size	A Overall Length		B Cutoff Allowance		H Hex Size		Maximum Working Pressure	
		inch	mm	inch	mm	inch	mm	psi	MPa
#									
1C3NX-8-4	M14 x 1.5	2.45	62	1.20	30	0.75	19	10,440	72.0

## 2380N-04-D Twin Line **polyflex** Hose

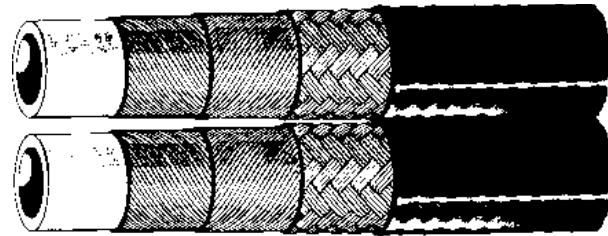

**B**

Part Number	Jacket Color	Minimum I.D.		Maximum O.D.		Maximum Working Pressure with 2.5:1 Safety Factor		Maximum Working Pressure with 4:1 Safety Factor		Minimum Burst Pressure		Minimum Bend Radius		Weight	
		inch	mm	inch	mm	psi	MPa	psi	MPa	psi	MPa	inch	mm	lbs/ft	kg/m
#															
2380N-04V00	Black	0.25	6	0.53	13	16,240	112.0	10,150	70.0	40,600	280.0	2.76	70	0.22	0.33
2380N-04V02	Blue	0.25	6	0.53	13	16,240	112.0	10,150	70.0	40,600	280.0	2.76	70	0.22	0.33
2380N-04V04	Red	0.25	6	0.53	13	16,240	112.0	10,150	70.0	40,600	280.0	2.76	70	0.22	0.33

**Construction:** Polyamide core tube, high strength wire reinforced and a polyurethane outer cover.

**Typical Applications:** Industrial equipment, rescue equipment, hydraulic tools.

Assembly includes any combination of two hoses (mix or match 2245N-04-D and 2380N-04-D) with any fitting listed for that hose.

## National Pipe Tapered (NPT) Male Fitting 01

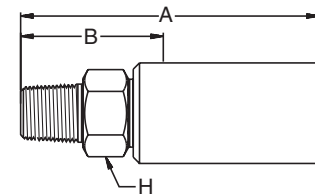

Part Number	Connection Type Thread Size	A Overall Length		B Cutoff Allowance		H Hex Size		Maximum Working Pressure	
		inch	mm	inch	mm	inch	mm	psi	MPa
#									
1018X-6-4	3/8" NPT	2.72	69	1.47	37	0.75	19	15,000	103.4
6018X-4-4	1/4" NPT	2.62	67	1.37	35	0.63	16	15,000	103.4
601LX-4-4C	1/4" NPT	2.62	67	1.37	35	0.63	16	15,000	103.4

## Type "M" Female Swivel Fitting AY

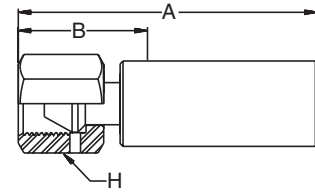

Part Number	Connection Type Thread Size	A Overall Length		B Cutoff Allowance		H Hex Size		Maximum Working Pressure	
		inch	mm	inch	mm	inch	mm	psi	MPa
#									
6AY8X-6-4	9/16" - 18	2.54	65	1.30	33	0.75	19	16,240	112.0
6AYLX-6-4C	9/16" - 18	2.69	68	1.39	35	0.68	17	16,240	112.0
6AYLX-6-4C-SD *	9/16" - 18	2.54	65	1.30	33	0.75	19	16,240	112.0

\*SD – Corrosion resistant (sea water)

## JIC Female Swivel Fitting 06

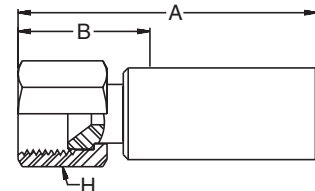

Part Number	Connection Type Thread Size	A Overall Length		B Cutoff Allowance		H Hex Size		Maximum Working Pressure	
		inch	mm	inch	mm	inch	mm	psi	MPa
#									
1068X-4-4	7/16" - 20	2.64	67	1.37	35	0.75	19	10,000	69.0
1068X-6-4	9/16" - 18	2.58	66	1.30	33	0.75	19	10,000	69.0
6069X-4-4C	7/16" - 20	2.24	57	0.98	25	0.63	16	10,000	69.0
6069X-6-4C	9/16" - 18	2.36	60	1.10	28	0.68	17	10,000	69.0

## Medium Pressure Female Swivel Fitting 5Y

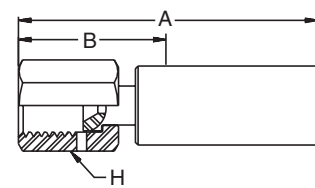





Part Number	Connection Type Thread Size	A Overall Length		B Cutoff Allowance		H Hex Size		Maximum Working Pressure	
		inch	mm	inch	mm	inch	mm	psi	MPa
#									
65Y8X-6-4	9/16" - 18	2.78	71	1.55	39	0.75	19	16,240	112.0
65YLX-6-4C	9/16" - 18	2.84	72	1.54	39	0.75	19	16,240	112.0

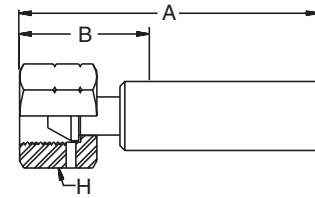

## BSP Female Swivel Fitting

92







Part Number	Connection Type Thread Size	A Overall Length		B Cutoff Allowance		H Hex Size		Maximum Working Pressure	
		inch	mm	inch	mm	inch	mm	psi	MPa
#									
6928X-4-4	1/4" BSPP	2.51	64	1.27	32	0.75	19	16,240	112.0

**B**

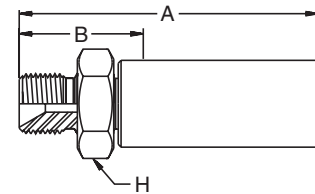
## BSP Male Fitting

D9





Part Number	Connection Type Thread Size	A Overall Length		B Cutoff Allowance		H Hex Size		Maximum Working Pressure	
		inch	mm	inch	mm	inch	mm	psi	MPa
#									
1D98X-4-4	1/4" BSPP	2.65	67	1.39	35	0.75	19	16,240	112.0

## Male Stecko Fitting

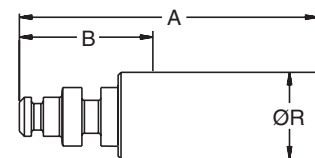
MB

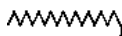



Part Number	Connection Type Thread Size	A Overall Length		B Cutoff Allowance		R Diameter		Maximum Working Pressure	
		inch	mm	inch	mm	inch	mm	psi	MPa
#									
1MB8X-6-4	None	2.85	72	1.58	40	0.86	22	10,000	69.0

# Metric Female Swivel Fitting

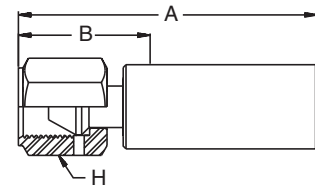
## C3

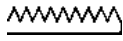

Part Number	Connection Type Thread Size	A Overall Length		B Cutoff Allowance		H Hex Size		Maximum Working Pressure	
		inch	mm	inch	mm	inch	mm	psi	MPa
#									
1C38X-4-4	M14 x 1.5	2.45	62	1.20	30	0.75	19	16,240	112.0

## Bundles

Parflex (10,000 psi hose and lower) can be combined with **polyflex** hose (10,000 psi and above) in custom engineered umbilicals, also referred to as hose bundles. Our technical staff will help design a product to meet your specifications and routing requirements. Strength members, tubing, electrical cables, pneumatic lines, and more can be combined with hose, inside of a protective jacket per your custom specifications.

Typical applications include offshore and land-based exploration and drilling operations, hydraulic tool supply lines, medical tools, surface preparation, robotics, construction equipment, and many others.

**polyflex**'s unique manufacturing process can produce very long lengths of steel reinforced thermoplastic hose with very low volumetric expansion characteristics.

**High pressure, long lengths, light weight and fast response times** are features that account for the success of **polyflex** hose umbilicals.

Contact the division or visit our website with your ideas and requirements.

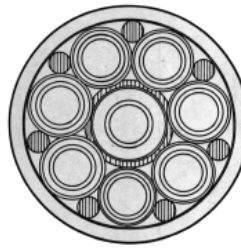

**B**



## Table of Contents

### Type M

YAYA .....	C4
YAY6 .....	C4
Plugs, caps and torpedos .....	C5
YAY5 .....	C6
YA02 .....	C6
YA01 .....	C7

### 20,000 PSI –Medium Pressure

5YY5 .....	C9
5YY6 .....	C10
6YY5 .....	C10
5Y01 .....	C11
025Y .....	C12
5Y5Y .....	C13
5Y5Y .....	C13
5Y6Y .....	C14
5Y02 .....	C15
Y5Y5 .....	C16
Y5Y6 .....	C16
Y501 .....	C17
L5Y .....	C17
T5Y .....	C18
X5Y .....	C18
Y2N .....	C19
Y2C .....	C19
Plugs .....	C19
Nipples .....	C19

### 30,000/60,000 PSI –High Pressure

6YY6 .....	C21
6Y01 .....	C21
02Y6 .....	C22
Y6Y6 .....	C22
Y601 .....	C23
6Y6Y .....	C23, C24
6Y02 .....	C24



 Contact Parflex for current price and delivery information on shaded parts.

(Continued)

**Table of Contents (Continued)**

**30,000/60,000 PSI — High Pressure (Continued)**

L6Y .....	C25
T6Y .....	C25
X6Y .....	C25
Y4N .....	C26
Y4C .....	C26
HBPHM .....	C26
Nipples .....	C26
Locking Nut and Collar .....	C26

**NPT**

Couplers .....	C27
Elbows .....	C27
Crosses .....	C28
Tees .....	C28
Nipples .....	C29
Reducer Bushings .....	C29

**Valves — Medium Pressure**

SV5Y .....	C30
AV5Y .....	C31
TV25Y .....	C31
TV15Y .....	C32
CV5Y .....	C32

**Valves — High Pressure**

SV6Y .....	C33
AV6Y .....	C33
TV26Y .....	C34
TV16Y .....	C34
SV6Y .....	C35
AV6Y .....	C35
TV26Y .....	C36
TV16Y .....	C36
CV6Y .....	C36

## Type "M" Swivel Hose Fitting and Adapters

### Sizes

Determined by hose type.

9/16" - 18 thd

7/8" - 14 thd

3/4" - 16 thd

1" - 12 thd

1 5/16" - 12 thd

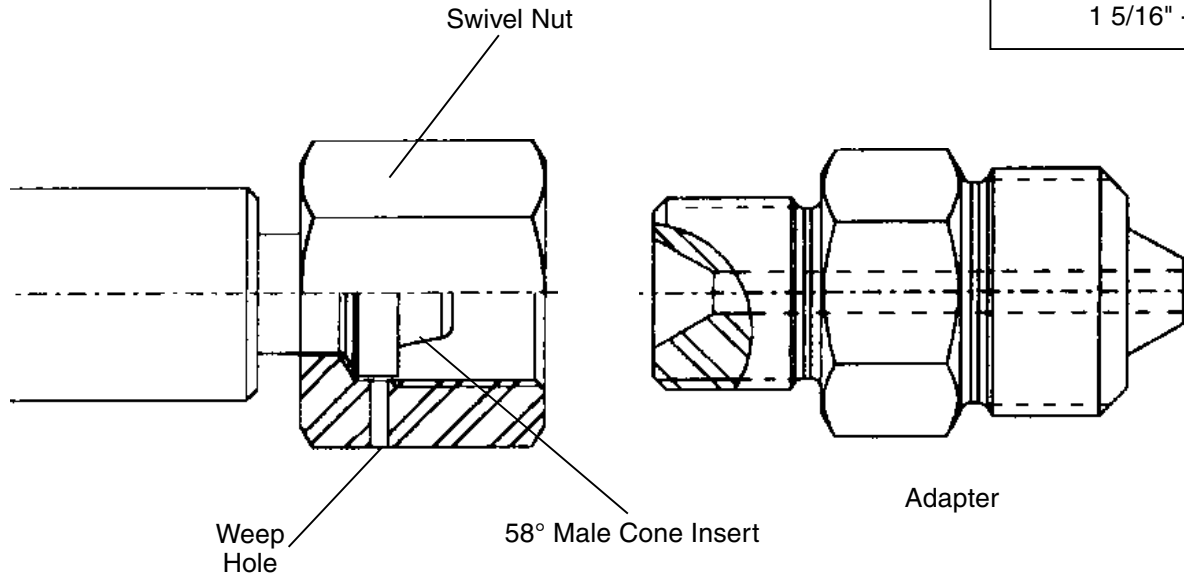

The Type "M" Swivel End Fitting is a swivel nut fitting with a 58° male cone hose insert. **Each Type "M" Swivel End Fitting is rated for the full working pressure of the hose.**

### Advantages:

- Rated for the full working pressure of hose.
- Provides a swivel for quick and easy connection.
- Internal threads and seal are protected from external damage.
- Non rotating seal reduces galling and minimizes tightening torque.
- Can be adapted to almost any connection required.

## YAYA

Type "M" Male x Type "M" Male

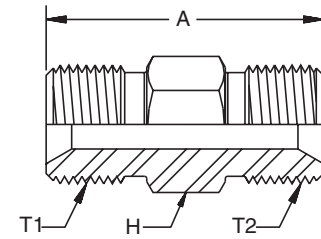

Part Number	Thread Size T1	Thread Size T2	A Overall Length	H Hex Size	Maximum Working Pressure
#					
			inch	inch	psi
YAYA-6-6C	9/16" - 18 UNF	9/16" - 18 UNF	1.38	0.63	60,000
YAYA-8-6C	3/4" - 16 UNF	9/16" - 18 UNF	1.63	0.75	30,000
YAYA-8-8C	3/4" - 16 UNF	3/4" - 16 UNF	1.75	0.75	30,000
YAYA-10-6C	7/8" - 14 UNF	9/16" - 18 UNF	1.88	1.00	60,000
YAYA-10-10C	7/8" - 14 UNF	7/8" - 14 UNF	2.00	1.00	60,000
YAYA-11-8C	1" - 12 UNF	3/4" - 16 UNF	1.88	1.00	26,000
YAYA-11-11C	1" - 12 UNF	1" - 12 UNF	1.88	1.00	26,000
YAYA-16-11C	1-5/16" - 12 UNF	1" - 12 UNF	2.13	1.38	20,000
YAYA-16-16C	1-5/16" - 12 UNF	1-5/16" - 12 UNF	2.13	1.38	20,000

## YAY6

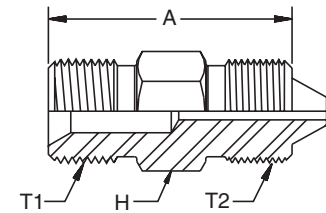

Type "M" Male x High Pressure



Part Number	Thread Size T1	Thread Size T2	Nom. Tube Size	A Overall Length	H Hex Size	Maximum Working Pressure
#						
				inch	inch	psi
YAY6-6-4C	9/16" - 18 UNF	9/16" - 18 UNF	1/4" HP	1.53	0.63	60,000
YAY6-6-6C	9/16" - 18 UNF	3/4" - 16 UNF	3/8" HP	1.75	0.75	60,000
YAY6-6-9C	9/16" - 18 UNF	1-1/8" - 12 UNF	9/16" HP	2.00	1.13	60,000
YAY6-8-6C	3/4" - 16 UNF	3/4" - 16 UNF	3/8" HP	2.00	0.75	30,000
YAY6-8-9C	3/4" - 16 UNF	1-1/8" - 12 UNF	9/16" HP	2.25	1.13	30,000
YAY6-10-6C	7/8" - 14 UNF	3/4" - 16 UNF	3/8" HP	2.25	1.00	60,000
YAY6-10-9C	7/8" - 14 UNF	1-1/8" - 12 UNF	9/16" HP	2.38	1.13	60,000
YAY6-11-9C	1" - 12 UNF	1-1/8" - 12 UNF	9/16" HP	2.25	1.13	26,000



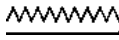

## Plugs

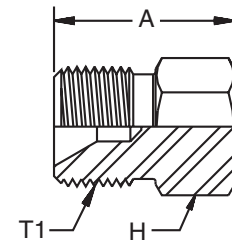
Part Number	Thread Size T1	A Overall Length	H Hex Size	Maximum Working Pressure
#				
		inch	inch	psi
YA6C-PLUG	9/16" - 18	2.07	0.75	60,000
YA8C-PLUG	3/4" - 16	2.13	1.00	30,000
YA11C-PLUG	1" - 12	1.25	1.00	30,000
YA16C-PLUG	1-5/16" - 12	2.63	1.38	20,000



**C**

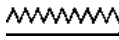

## Caps

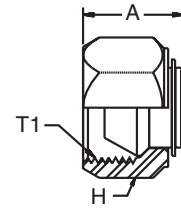
Part Number	Thread Size T1	A Overall Length	H Hex Size	Maximum Working Pressure
#				
		inch	inch	psi
AY6C-CAP	9/16" - 18	0.85	0.69	60,000
AY8C-CAP	3/4" - 16	0.91	1.00	30,000
AY11C-CAP	1" - 12	1.31	1.25	30,000
AY16C-CAP	1-5/16" - 12	1.20	1.50	20,000

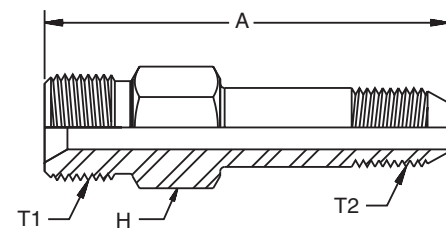

## Torpedos

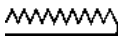

Part Number	Thread Size T1	Thread Size T2	A Overall Length	H Hex Size	Maximum Working Pressure
#					
			inch	inch	psi
YAY1-8-16C	3/4" - 16	1" - 14 LH	3.56	1.13	20,000
YAY2-8-16C	3/4" - 16	1" - 14 LH	3.56	1.38	20,000
YAY1-11-16C	1" - 12	1" - 14 LH	3.56	1.13	20,000
YAY2-11-16C	1" - 12	1" - 14 LH	3.56	1.38	20,000
YAY1-16-16C	1-5/16" - 12	1" - 14 LH	3.70	1.38	20,000
YAY2-16-16C	1-5/16" - 12	1" - 14 LH	3.70	1.38	20,000

## YAY5

### Type "M" Male x Medium Pressure

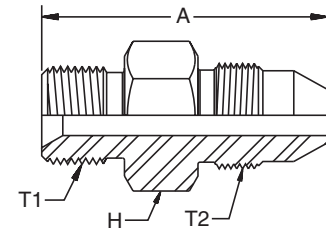

Part Number	Thread Size T1	Thread Size T2	Nom. Tube Size	A Overall Length	H Hex Size	Maximum Working Pressure
#						
				inch	inch	psi
YAY5-6-4C	9/16" - 18 UNF	7/16" - 20 UNF	1/4" MP	1.56	0.63	20,000
YAY5-6-6C	9/16" - 18 UNF	9/16" - 18 UNF	3/8" MP	1.63	0.63	20,000
YAY5-6-9C	9/16" - 18 UNF	13/16" - 16 UNF	9/16" MP	2.00	0.88	20,000
YAY5-6-12C	9/16" - 18 UNF	3/4" - 14 NPS	3/4" MP	2.32	1.13	20,000
YAY5-8-6C	3/4" - 16 UNF	9/16" - 18 UNF	3/8" MP	1.88	0.75	20,000
YAY5-8-9C	3/4" - 16 UNF	13/16" - 16 UNF	9/16" MP	2.20	0.88	20,000
YAY5-8-12C	3/4" - 16 UNF	3/4" - 14 NPS	3/4" MP	2.44	1.13	20,000
YAY5-11-6C	1" - 12 UNF	9/16" - 18 UNF	3/8" MP	2.00	1.00	20,000
YAY5-11-9C	1" - 12 UNF	13/16" - 16 UNF	9/16" MP	2.25	1.00	20,000
YAY5-11-12C	1" - 12 UNF	3/4" - 14 NPS	3/4" MP	2.44	1.13	20,000
YAY5-16-9C	1-5/16" - 12 UNF	9/16" - 18 UNF	9/16" MP	2.50	1.38	20,000
YAY5-16-12C	1-5/16" - 12 UNF	13/16" - 16 UNF	3/4" MP	2.70	1.38	20,000

## YA02

### Type "M" Male x National Pipe Thread (NPT) Female

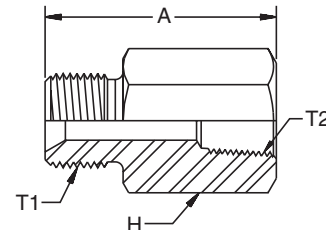

Part Number	Thread Size T1	Thread Size T2	A Overall Length	H Hex Size	Maximum Working Pressure
#					
			inch	inch	psi
YA02-6-4C	9/16" - 18 UNF	1/4" - 18 NPT	1.50	0.75	15,000
YA02-6-8C	9/16" - 18 UNF	1/2" - 14 NPT	2.00	1.25	15,000
YA02-8-8C	3/4" - 16 UNF	1/2" - 14 NPT	2.00	1.25	15,000
YA02-11-8C	1" - 12 UNF	1/2" - 14 NPT	2.50	1.00	15,000

# YA01

## Type "M" Male x National Pipe Thread (NPT) Male

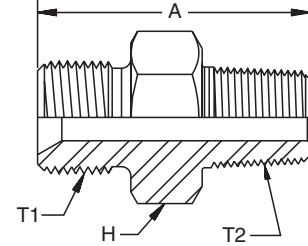

Part Number	Thread Size T1	Thread Size T2	A Overall Length	H Hex Size	Maximum Working Pressure
#					
			inch	inch	psi
YA01-6-2C	9/16 - 18 UNF	1/8" - 27 NPT	1.28	0.63	15,000
YA01-6-4C	9/16 - 18 UNF	1/4" - 18 NPT	1.38	0.63	15,000
YA01-6-6C	9/16 - 18 UNF	3/8" - 18 NPT	1.57	0.75	15,000
YA01-6-8C	9/16 - 18 UNF	1/2" - 14 NPT	1.75	0.88	15,000
YA01-8-4C	3/4" - 16 UNF	1/4" - 18 NPT	1.80	0.75	15,000
YA01-8-6C	3/4" - 16 UNF	3/8" - 18 NPT	1.73	0.75	15,000
YA01-8-8C	3/4" - 16 UNF	1/2" - 14 NPT	1.95	0.88	15,000
YA01-8-12C	3/4" - 16 UNF	3/4" - 12 NPT	2.13	1.13	10,000
YA01-8-16C	3/4" - 16 UNF	1" - 11-1/2 NPT	2.38	1.38	10,000
YA01-11-6C	1" - 12 UNF	3/8" - 18 NPT	1.85	1.00	15,000
YA01-11-8C	1" - 12 UNF	1/2" - 14 NPT	2.00	1.00	15,000
YA01-11-12C	1" - 12 UNF	3/4" - 12 NPT	2.13	1.13	10,000
YA01-11-16C	1" - 12 UNF	1" - 11-1/2 NPT	2.38	1.38	10,000
YA01-16-8C	1-5/16" - 12 UNF	1/2" - 14 NPT	2.13	1.38	15,000
YA01-16-12C	1-5/16" - 12 UNF	3/4" - 12 NPT	2.38	1.38	10,000
YA01-16-16C	1-5/16" - 12 UNF	1" - 11-1/2 NPT	2.50	1.38	10,000
YA01-16-20C	1-5/16" - 12 UNF	1-1/4" - 11-1/2 NPT	2.75	1.75	10,000
YA01-16-24C	1-5/16" - 12 UNF	1-1/2" - 11-1/2 NPT	2.75	2.00	10,000
YA01-16-32C	1-5/16" - 12 UNF	2" - 11-1/2 NPT	2.75	2.38	10,000



## Medium Pressure

### Sizes

1/4" O.D. x 0.109" I.D. • 7/16" - 20 male thread on gland nut  
3/8" O.D. x 0.19" I.D. • 9/16" - 18 male thread on gland nut  
9/16" O.D. x 0.31" I.D. • 13/16" - 16 male thread on gland nut  
3/4" O.D. x 0.44" I.D. • 3/4" - National Pipe Straight male  
1" O.D. x 0.56" I.D. • 1-3/8" - 12 male thread on gland nut

Identification is by tubing O.D.

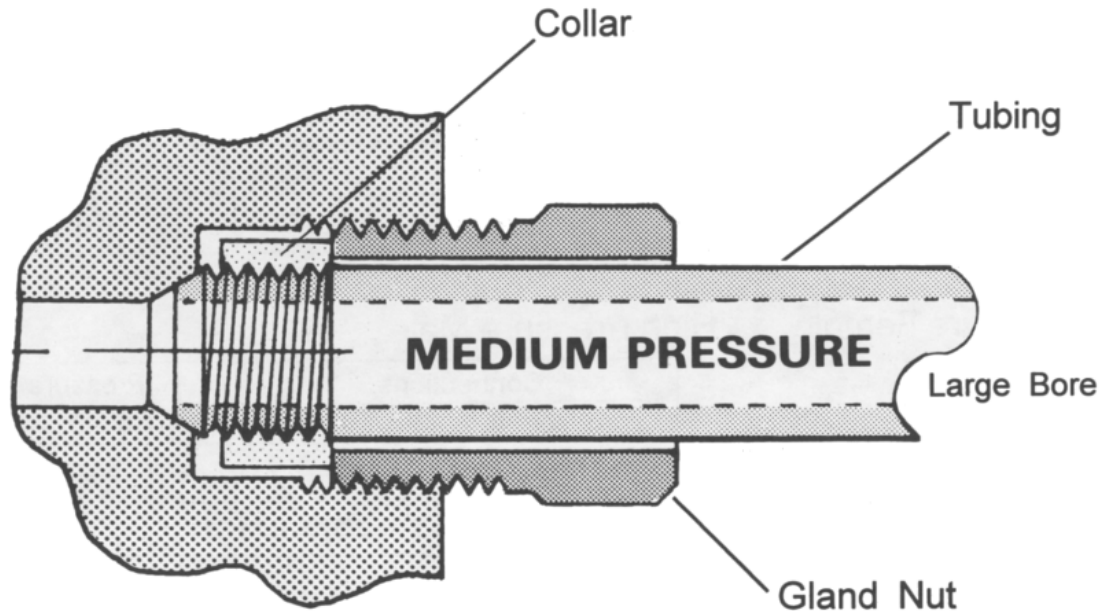

**Medium Pressure** is a 58/60 degree coned and threaded tubing design. *They have a maximum working pressure rating of 20,000 psi.*

### Advantages:

- An industry standard for use at elevated pressures.
- Large orifice allows maximum flow of liquids and gases.
- Suitable for repetitive assembly and disassembly.

## 5YY5

### Female Medium Pressure to Male Medium Pressure

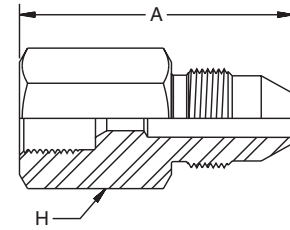

Part Number	Connection Type	A Overall Length	H Hex Size	Maximum Working Pressure
#				
		inch	inch	psi
5YY5-4-6C	1/4" M.P. Female to 3/8" M.P. Male	1.75	0.75	20,000
5YY5-4-9C	1/4" M.P. Female to 9/16" M.P. Male	1.87	0.87	20,000
5YY5-4-12C	1/4" M.P. Female to 3/4" M.P. Male	2.00	1.12	20,000
5YY5-4-16C	1/4" M.P. Female to 1" M.P. Male	3.00	1.00	20,000
5YY5-6-4C	3/8" M.P. Female to 1/4" M.P. Male	1.75	0.75	20,000
5YY5-6-9C	3/8" M.P. Female to 9/16" M.P. Male	1.87	0.87	20,000
5YY5-6-12C	3/8" M.P. Female to 3/4" M.P. Male	2.00	1.12	20,000
5YY5-6-16C	3/8" M.P. Female to 1" M.P. Male	3.12	1.00	20,000
5YY5-9-4C	9/16" M.P. Female to 1/4" M.P. Male	2.12	1.00	20,000
5YY5-9-6C	9/16" M.P. Female to 3/8" M.P. Male	2.12	1.00	20,000
5YY5-9-12C	9/16" M.P. Female to 3/4" M.P. Male	2.50	1.12	20,000
5YY5-9-16C	9/16" M.P. Female to 1" M.P. Male	3.37	1.00	20,000
5YY5-12-4C	3/4" M.P. Female to 1/4" M.P. Male	1.25	1.37	20,000
5YY5-12-6C	3/4" M.P. Female to 3/8" M.P. Male	2.37	1.37	20,000
5YY5-12-9C	3/4" M.P. Female to 9/16" M.P. Male	2.87	1.37	20,000
5YY5-12-16C	3/4" M.P. Female to 1" M.P. Male	3.75	1.37	20,000
5YY5-16-4C	1" M.P. Female to 1/4" M.P. Male	2.75	1.75	20,000
5YY5-16-6C	1" M.P. Female to 3/8" M.P. Male	2.87	1.75	20,000
5YY5-16-9C	1" M.P. Female to 9/16" M.P. Male	3.00	1.75	20,000
5YY5-16-12C	1" M.P. Female to 3/4" M.P. Male	3.25	1.75	20,000



## 5YY6

### Female Medium Pressure to Male High Pressure

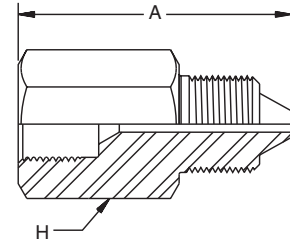

Part Number	Connection Type	A Overall Length	H Hex Size	Maximum Working Pressure
#				
		inch	inch	psi
5YY6-4-4C	1/4" M.P. Female to 1/4" H.P. Male	1.37	0.75	20,000
5YY6-4-6C	1/4" M.P. Female to 3/8" H.P. Male	1.75	0.75	20,000
5YY6-4-9C	1/4" M.P. Female to 9/16" H.P. Male	2.12	1.12	20,000
5YY6-6-4C	3/8" M.P. Female to 1/4" H.P. Male	1.75	0.75	20,000
5YY6-6-6C	3/8" M.P. Female to 3/8" H.P. Male	1.75	0.75	20,000
5YY6-6-9C	3/8" M.P. Female to 9/16" H.P. Male	2.12	1.12	20,000
5YY6-9-4C	9/16" M.P. Female to 1/4" H.P. Male	1.87	1.00	20,000
5YY6-9-6C	9/16" M.P. Female to 3/8" H.P. Male	2.12	1.00	20,000
5YY6-9-9C	9/16" M.P. Female to 9/16" H.P. Male	2.12	1.12	20,000
5YY6-12-4C	3/4" M.P. Female to 1/4" H.P. Male	2.50	1.37	20,000
5YY6-12-6C	3/4" M.P. Female to 3/8" H.P. Male	2.37	1.37	20,000
5YY6-12-9C	3/4" M.P. Female to 9/16" H.P. Male	2.62	1.37	20,000
5YY6-16-4C	1" M.P. Female to 1/4" H.P. Male	2.62	1.75	20,000
5YY6-16-6C	1" M.P. Female to 3/8" H.P. Male	2.87	1.75	20,000
5YY6-16-9C	1" M.P. Female to 9/16" H.P. Male	3.12	1.75	20,000

## 6YY5

### Female High Pressure to Male Medium Pressure

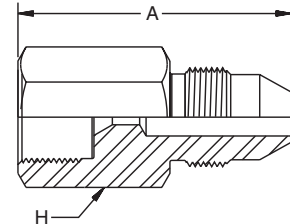

Part Number	Connection Type	A Overall Length	H Hex Size	Maximum Working Pressure
#				
		inch	inch	psi
6YY5-4-4C	1/4" H.P. Female to 1/4" M.P. Male	1.75	0.75	20,000
6YY5-4-6C	1/4" H.P. Female to 3/8" M.P. Male	1.75	0.75	20,000
6YY5-4-9C	1/4" H.P. Female to 9/16" M.P. Male	1.87	0.87	20,000
6YY5-4-12C	1/4" H.P. Female to 3/4" M.P. Male	2.25	1.12	20,000
6YY5-4-16C	1/4" H.P. Female to 1" M.P. Male	3.00	1.00	20,000
6YY5-6-4C	3/8" H.P. Female to 1/4" M.P. Male	1.87	1.00	20,000
6YY5-6-6C	3/8" H.P. Female to 3/8" M.P. Male	1.87	1.00	20,000
6YY5-6-9C	3/8" H.P. Female to 9/16" M.P. Male	2.00	1.00	20,000
6YY5-6-12C	3/8" H.P. Female to 3/4" M.P. Male	2.25	1.12	20,000
6YY5-6-16C	3/8" H.P. Female to 1" M.P. Male	3.25	1.00	20,000
6YY5-9-4C	9/16" H.P. Female to 1/4" M.P. Male	2.12	1.37	20,000
6YY5-9-6C	9/16" H.P. Female to 3/8" M.P. Male	2.12	1.37	20,000
6YY5-9-9C	9/16" H.P. Female to 9/16" M.P. Male	2.37	1.37	20,000
6YY5-9-12C	9/16" H.P. Female to 3/4" M.P. Male	2.50	1.37	20,000
6YY5-9-16C	9/16" H.P. Female to 1" M.P. Male	3.62	1.37	20,000

# 5Y01

## Female Medium Pressure to National Pipe Thread (NPT) Male

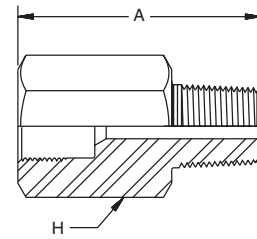



Part Number	Connection Type	A Overall Length	H Hex Size	Maximum Working Pressure
#				
		inch	inch	psi
5Y01-4-2C	1/4" M.P. Female to 1/8" NPT Male	1.43	0.75	15,000
5Y01-4-4C	1/4" M.P. Female to 1/4" NPT Male	1.62	0.75	15,000
5Y01-4-6C	1/4" M.P. Female to 3/8" NPT Male	1.62	0.75	15,000
5Y01-4-8C	1/4" M.P. Female to 1/2" NPT Male	1.75	1.00	15,000
5Y01-4-12C	1/4" M.P. Female to 3/4" NPT Male	1.87	1.37	10,000
5Y01-4-16C	1/4" M.P. Female to 1" NPT Male	1.87	1.37	10,000
5Y01-6-2C	3/8" M.P. Female to 1/8" NPT Male	1.43	0.75	15,000
5Y01-6-4C	3/8" M.P. Female to 1/4" NPT Male	1.62	0.75	15,000
5Y01-6-6C	3/8" M.P. Female to 3/8" NPT Male	1.62	0.75	15,000
5Y01-6-8C	3/8" M.P. Female to 1/2" NPT Male	1.74	1.00	15,000
5Y01-6-12C	3/8" M.P. Female to 3/4" NPT Male	1.87	1.37	10,000
5Y01-6-16C	3/8" M.P. Female to 1" NPT Male	1.87	1.37	10,000
5Y01-9-2C	9/16" M.P. Female to 1/8" NPT Male	1.87	1.00	15,000
5Y01-9-4C	9/16" M.P. Female to 1/4" NPT Male	1.87	1.00	15,000
5Y01-9-6C	9/16" M.P. Female to 3/8" NPT Male	1.87	1.00	15,000
5Y01-9-8C	9/16" M.P. Female to 1/2" NPT Male	1.87	1.00	15,000
5Y01-9-12C	9/16" M.P. Female to 3/4" NPT Male	1.87	1.37	10,000
5Y01-9-16C	9/16" M.P. Female to 1" NPT Male	1.87	1.37	10,000
5Y01-12-2C	3/4" M.P. Female to 1/8" NPT Male	2.50	1.37	15,000
5Y01-12-4C	3/4" M.P. Female to 1/4" NPT Male	2.50	1.37	15,000
5Y01-12-6C	3/4" M.P. Female to 3/8" NPT Male	2.50	1.37	15,000
5Y01-12-8C	3/4" M.P. Female to 1/2" NPT Male	2.50	1.37	15,000
5Y01-12-12C	3/4" M.P. Female to 3/4" NPT Male	2.50	1.37	15,000
5Y01-12-16C	3/4" M.P. Female to 1" NPT Male	2.50	1.37	15,000
5Y01-16-2C	1" M.P. Female to 1/8" NPT Male	2.50	1.37	15,000
5Y01-16-4C	1" M.P. Female to 1/4" NPT Male	2.50	1.37	15,000
5Y01-16-6C	1" M.P. Female to 3/8" NPT Male	2.50	1.37	15,000
5Y01-16-8C	1" M.P. Female to 1/2" NPT Male	2.50	1.37	15,000
5Y01-16-12C	1" M.P. Female to 3/4" NPT Male	2.50	1.37	15,000
5Y01-16-16C	1" M.P. Female to 1" NPT Male	2.50	1.37	10,000

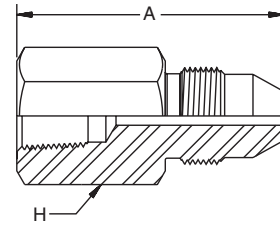

## 02Y5

### Female NPT to Male Medium Pressure

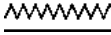

Part Number	Connection Type	A Overall Length	H Hex Size	Maximum Working Pressure
#				
		inch	inch	psi
02Y5-2-12C	1/8" NPT Female to 3/4" M.P. Male	2.00	1.12	15,000
02Y5-2-16C	1/8" NPT Female to 1" M.P. Male	3.00	1.00	15,000
02Y5-2-4C	1/8" NPT Female to 1/4" M.P. Male	1.75	0.75	15,000
02Y5-2-6C	1/8" NPT Female to 3/8" M.P. Male	1.87	0.75	15,000
02Y5-2-9C	1/8" NPT Female to 9/16" M.P. Male	1.87	0.87	15,000
02Y5-4-4C	1/4" NPT Female to 1/4" M.P. Male	1.75	0.75	15,000
02Y5-4-6C	1/4" NPT Female to 3/8" M.P. Male	1.87	0.75	15,000
02Y5-4-9C	1/4" NPT Female to 9/16" M.P. Male	1.87	0.87	15,000
02Y5-4-12C	1/4" NPT Female to 3/4" M.P. Male	2.00	1.12	15,000
02Y5-4-16C	1/4" NPT Female to 1" M.P. Male	3.00	1.00	15,000
02Y5-6-4C	3/8" NPT Female to 1/4" M.P. Male	2.00	1.00	15,000
02Y5-6-6C	3/8" NPT Female to 3/8" M.P. Male	2.12	1.00	15,000
02Y5-6-9C	3/8" NPT Female to 9/16" M.P. Male	2.25	1.00	15,000
02Y5-6-12C	3/8" NPT Female to 3/4" M.P. Male	2.00	1.12	15,000
02Y5-6-16C	3/8" NPT Female to 1" M.P. Male	3.00	1.00	15,000
02Y5-8-4C	1/2" NPT Female to 1/4" M.P. Male	2.12	1.12	15,000
02Y5-8-6C	1/2" NPT Female to 3/8" M.P. Male	1.25	1.12	15,000
02Y5-8-9C	1/2" NPT Female to 9/16" M.P. Male	2.37	1.12	15,000
02Y5-8-12C	1/2" NPT Female to 3/4" M.P. Male	2.50	1.12	15,000
02Y5-8-16C	1/2" NPT Female to 1" M.P. Male	3.75	1.12	15,000
02Y5-12-4C	3/4" NPT Female to 1/4" M.P. Male	2.37	1.37	10,000
02Y5-12-6C	3/4" NPT Female to 3/8" M.P. Male	2.50	1.37	10,000
02Y5-12-9C	3/4" NPT Female to 9/16" M.P. Male	2.62	1.37	10,000
02Y5-12-12C	3/4" NPT Female to 3/4" M.P. Male	2.75	1.50	10,000
02Y5-12-16C	3/4" NPT Female to 1" M.P. Male	4.12	1.50	10,000
02Y5-16-6C	1" NPT Female to 3/8" M.P. Male	2.87	1.87	10,000
02Y5-16-9C	1" NPT Female to 9/16" M.P. Male	3.00	1.87	10,000
02Y5-16-12C	1" NPT Female to 3/4" M.P. Male	3.00	1.87	10,000
02Y5-16-16C	1" NPT Female to 1" M.P. Male	4.37	1.87	10,000



## 5Y5Y Straight Coupling

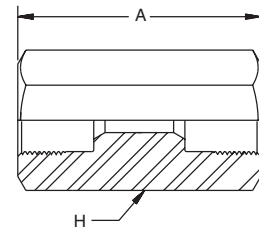

Part Number	Connection Type	A Overall Length	H Hex Size	Maximum Working Pressure
#				
		inch	inch	psi
5Y5Y-4-4C	1/4" Medium Pressure Female	1.62	0.75	20,000
5Y5Y-6-6C	3/8" Medium Pressure Female	1.75	0.75	20,000
5Y5Y-9-9C	9/16" Medium Pressure Female	2.12	1.00	20,000
5Y5Y-12-12C	3/4" Medium Pressure Female	2.50	1.37	20,000
5Y5Y-16-16C	1" Medium Pressure Female	3.50	1.75	20,000

**C**

## 5Y5Y Reducer Coupling

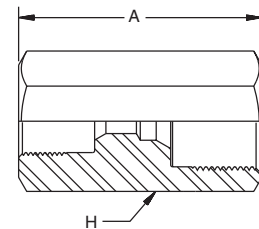

Part Number	Connection Type	A Overall Length	H Hex Size	Maximum Working Pressure
#				
		inch	inch	psi
5Y5Y-4-6C	1/4" M.P. Female to 3/8" M.P. Female	1.75	0.75	20,000
5Y5Y-4-9C	1/4" M.P. Female to 9/16" M.P. Female	2.12	1.00	20,000
5Y5Y-4-12C	1/4" M.P. Female to 3/4" M.P. Female	2.50	1.37	20,000
5Y5Y-4-16C	1/4" M.P. Female to 1" M.P. Female	3.50	1.75	20,000
5Y5Y-6-9C	3/8" M.P. Female to 9/16" M.P. Female	2.12	1.00	20,000
5Y5Y-6-12C	3/8" M.P. Female to 3/4" M.P. Female	2.50	1.37	20,000
5Y5Y-6-16C	3/8" M.P. Female to 1" M.P. Female	3.50	1.75	20,000
5Y5Y-9-12C	9/16" M.P. Female to 3/4" M.P. Female	2.50	1.37	20,000
5Y5Y-9-16C	9/16" M.P. Female to 1" M.P. Female	3.50	1.75	20,000
5Y5Y-12-16C	3/4" M.P. Female to 1" M.P. Female	3.50	1.75	20,000

# 5Y6Y

## Medium Pressure Female to High Pressure Female Coupling

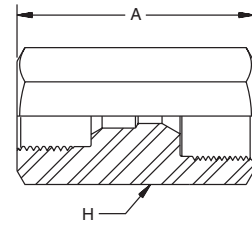

Part Number	Connection Type	A Overall Length	H Hex Size	Maximum Working Pressure
#				
		inch	inch	psi
5Y6Y-4-4C	1/4" M.P. Female to 1/4" H.P. Female	1.62	0.75	20,000
5Y6Y-4-6C	1/4" M.P. Female to 3/8" H.P. Female	1.87	1.00	20,000
5Y6Y-4-9C	1/4" M.P. Female to 9/16" H.P. Female	2.37	1.37	20,000
5Y6Y-6-4C	3/8" M.P. Female to 1/4" H.P. Female	1.75	0.75	20,000
5Y6Y-6-6C	3/8" M.P. Female to 3/8" H.P. Female	1.87	1.00	20,000
5Y6Y-6-9C	3/8" M.P. Female to 9/16" H.P. Female	2.37	1.37	20,000
5Y6Y-9-4C	9/16" M.P. Female to 1/4" H.P. Female	2.12	1.00	20,000
5Y6Y-9-6C	9/16" M.P. Female to 3/8" H.P. Female	2.12	1.00	20,000
5Y6Y-9-9C	9/16" M.P. Female to 9/16" H.P. Female	2.37	1.37	20,000
5Y6Y-12-4C	3/4" M.P. Female to 1/4" H.P. Female	2.50	1.37	20,000
5Y6Y-12-6C	3/4" M.P. Female to 3/8" H.P. Female	2.50	1.37	20,000
5Y6Y-12-9C	3/4" M.P. Female to 9/16" H.P. Female	2.50	1.37	20,000
5Y6Y-16-4C	1" M.P. Female to 1/4" H.P. Female	3.50	1.37	20,000
5Y6Y-16-6C	1" M.P. Female to 3/8" H.P. Female	3.50	1.37	20,000
5Y6Y-16-9C	1" M.P. Female to 9/16" H.P. Female	3.50	1.37	20,000

# 5Y02

## Medium Pressure Female to NPT Female Coupling

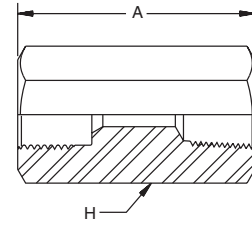

Part Number	Connection Type	A Overall Length	H Hex Size	Maximum Working Pressure
#				
		inch	inch	psi
5Y02-4-2C	1/4" M.P. Female to 1/8" NPT Female	1.62	0.75	15,000
5Y02-4-4C	1/4" M.P. Female to 1/4" NPT Female	1.62	0.75	15,000
5Y02-4-6C	1/4" M.P. Female to 3/8" NPT Female	2.00	1.00	15,000
5Y02-4-8C	1/4" M.P. Female to 1/2" NPT Female	2.00	1.12	15,000
5Y02-4-12C	1/4" M.P. Female to 3/4" NPT Female	2.37	1.37	10,000
5Y02-4-16C	1/4" M.P. Female to 1" NPT Female	2.62	2.00	10,000
5Y02-6-2C	3/8" M.P. Female to 1/8" NPT Female	1.75	0.75	15,000
5Y02-6-4C	3/8" M.P. Female to 1/4" NPT Female	1.75	0.75	15,000
5Y02-6-6C	3/8" M.P. Female to 3/8" NPT Female	2.12	1.00	15,000
5Y02-6-8C	3/8" M.P. Female to 1/2" NPT Female	2.12	1.12	15,000
5Y02-6-12C	3/8" M.P. Female to 3/4" NPT Female	2.37	1.37	10,000
5Y02-6-16C	3/8" M.P. Female to 1" NPT Female	2.75	2.00	10,000
5Y02-9-2C	9/16" M.P. Female to 1/8" NPT Female	2.12	1.00	15,000
5Y02-9-4C	9/16" M.P. Female to 1/4" NPT Female	2.12	1.00	15,000
5Y02-9-6C	9/16" M.P. Female to 3/8" NPT Female	2.12	1.00	15,000
5Y02-9-8C	9/16" M.P. Female to 1/2" NPT Female	2.25	1.12	15,000
5Y02-9-12C	9/16" M.P. Female to 3/4" NPT Female	2.50	1.37	10,000
5Y02-9-16C	9/16" M.P. Female to 1" NPT Female	2.87	2.00	10,000
5Y02-12-2C	3/4" M.P. Female to 1/8" NPT Female	2.50	1.37	15,000
5Y02-12-4C	3/4" M.P. Female to 1/4" NPT Female	2.50	1.37	15,000
5Y02-12-6C	3/4" M.P. Female to 3/8" NPT Female	2.50	1.37	15,000
5Y02-12-8C	3/4" M.P. Female to 1/2" NPT Female	2.50	1.37	15,000
5Y02-12-12C	3/4" M.P. Female to 3/4" NPT Female	2.75	1.50	10,000
5Y02-12-16C	3/4" M.P. Female to 1" NPT Female	3.00	1.87	15,000
5Y02-16-2C	1" M.P. Female to 1/8" NPT Female	3.00	1.75	15,000
5Y02-16-4C	1" M.P. Female to 1/4" NPT Female	3.00	1.75	15,000
5Y02-16-6C	1" M.P. Female to 3/8" NPT Female	3.00	1.75	15,000
5Y02-16-8C	1" M.P. Female to 1/2" NPT Female	3.00	1.75	15,000
5Y02-16-12C	1" M.P. Female to 3/4" NPT Female	3.50	1.50	10,000
5Y02-16-16C	1" M.P. Female to 1" NPT Female	3.75	1.87	10,000



## Y5Y5

### Medium Pressure Male to Medium Pressure Male

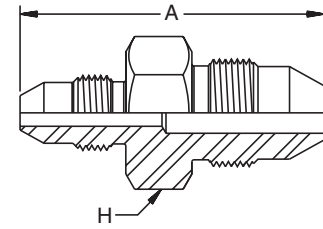

Part Number	Connection Type	A Overall Length	H Hex Size	Maximum Working Pressure
#				
		inch	inch	psi
Y5Y5-4-4C	1/4" M.P. Male to 1/4" M.P. Male	2.00	0.62	20,000
Y5Y5-4-6C	1/4" M.P. Male to 3/8" M.P. Male	2.12	0.75	20,000
Y5Y5-4-12C	1/4" M.P. Male to 3/4" M.P. Male	2.50	1.12	20,000
Y5Y5-4-16C	1/4" M.P. Male to 1" M.P. Male	3.62	1.00	20,000
Y5Y5-6-6C	3/8" M.P. Male to 3/8" M.P. Male	2.25	0.75	20,000
Y5Y5-6-9C	3/8" M.P. Male to 9/16" M.P. Male	2.50	0.87	20,000
Y5Y5-6-12C	3/8" M.P. Male to 3/4" M.P. Male	2.62	1.12	20,000
Y5Y5-6-16C	3/8" M.P. Male to 1" M.P. Male	3.75	1.00	20,000
Y5Y5-9-9C	9/16" M.P. Male to 9/16" M.P. Male	2.50	1.00	20,000
Y5Y5-9-12C	9/16" M.P. Male to 3/4" M.P. Male	2.87	1.12	20,000
Y5Y5-9-16C	9/16" M.P. Male to 1" M.P. Male	4.00	1.00	20,000
Y5Y5-12-12C	3/4" M.P. Male to 3/4" M.P. Male	3.00	1.12	20,000
Y5Y5-12-16C	3/4" M.P. Male to 1" M.P. Male	1.25	1.12	20,000

## Y5Y6

### Medium Pressure Male to High Pressure Male

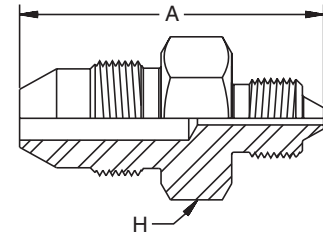

Part Number	Connection Type	A Overall Length	H Hex Size	Maximum Working Pressure
#				
		inch	inch	psi
Y5Y6-4-4C	1/4" M.P. Male to 1/4" H.P. Male	1.73	0.63	20,000
Y5Y6-4-6C	1/4" M.P. Male to 3/8" H.P. Male	2.10	0.75	20,000
Y5Y6-4-9C	1/4" M.P. Male to 9/16" H.P. Male	2.37	1.12	20,000
Y5Y6-6-4C	3/8" M.P. Male to 1/4" H.P. Male	2.12	0.62	20,000
Y5Y6-6-9C	3/8" M.P. Male to 9/16" H.P. Male	2.50	1.12	20,000
Y5Y6-9-4C	9/16" M.P. Male to 1/4" H.P. Male	2.25	0.87	20,000
Y5Y6-9-9C	9/16" M.P. Male to 9/16" H.P. Male	2.62	1.12	20,000
Y5Y6-12-4C	3/4" M.P. Male to 1/4" H.P. Male	2.62	1.12	20,000
Y5Y6-12-6C	3/4" M.P. Male to 3/8" H.P. Male	2.75	1.12	20,000
Y5Y6-12-9C	3/4" M.P. Male to 9/16" H.P. Male	3.00	1.12	20,000
Y5Y6-16-4C	1" M.P. Male to 1/4" H.P. Male	3.62	1.00	20,000
Y5Y6-16-6C	1" M.P. Male to 3/8" H.P. Male	4.00	1.00	20,000
Y5Y6-16-9C	1" M.P. Male to 9/16" H.P. Male	4.00	1.12	20,000

## Y501

### Medium Pressure Male to NPT Male

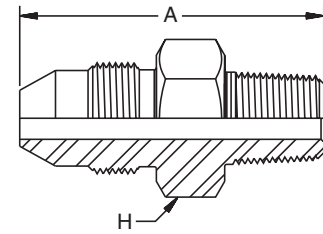

Part Number	Connection Type	A Overall Length	H Hex Size	Maximum Working Pressure
#				
		inch	inch	psi
Y501-4-4C	1/4" M.P. to 1/4" NPT Male	1.60	0.63	15,000
Y501-4-8C	1/4" M.P. to 1/2" NPT Male	2.12	0.87	15,000
Y501-6-4C	3/8" M.P. to 1/4" NPT Male	2.06	0.75	15,000
Y501-6-6C	3/8" M.P. to 3/8" NPT Male	2.06	0.75	15,000
Y501-6-8C	3/8" M.P. to 1/2" NPT Male	2.18	0.87	15,000
Y501-9-2C	9/16" M.P. to 1/8" NPT Male	2.12	0.87	15,000
Y501-9-4C	9/16" M.P. to 1/4" NPT Male	2.25	0.87	15,000
Y501-9-6C	9/16" M.P. to 3/8" NPT Male	2.25	0.87	15,000
Y501-9-8C	9/16" M.P. to 1/2" NPT Male	2.37	0.87	15,000
Y501-9-12C	9/16" M.P. to 3/4" NPT Male	2.62	1.12	10,000
Y501-9-16C	9/16" M.P. to 1" NPT Male	2.62	1.37	10,000
Y501-12-2C	3/4" M.P. to 1/8" NPT Male	2.37	1.12	15,000
Y501-12-4C	3/4" M.P. to 1/4" NPT Male	2.50	1.12	15,000
Y501-12-6C	3/4" M.P. to 3/8" NPT Male	2.50	1.12	15,000
Y501-12-8C	3/4" M.P. to 1/2" NPT Male	2.62	1.12	15,000
Y501-12-12C	3/4" M.P. to 3/4" NPT Male	2.75	1.12	10,000
Y501-12-16C	3/4" M.P. to 1" NPT Male	3.00	1.37	10,000
Y501-16-2C	1" M.P. to 1/8" NPT Male	3.62	1.00	15,000
Y501-16-4C	1" M.P. to 1/4" NPT Male	3.75	1.00	15,000
Y501-16-6C	1" M.P. to 3/8" NPT Male	3.75	1.00	15,000
Y501-16-8C	1" M.P. to 1/2" NPT Male	3.87	1.00	15,000
Y501-16-12C	1" M.P. to 3/4" NPT Male	3.87	1.12	10,000
Y501-16-16C	1" M.P. to 1" NPT Male	4.00	1.37	10,000



## L5Y

### Medium Pressure Elbow

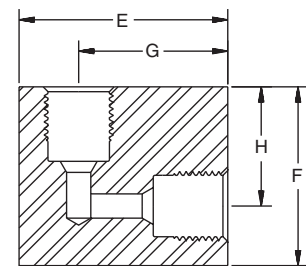

Part Number	Connection Type	Thickness	E	F	G	H	Maximum Working Pressure
#							
		inch	inch	inch	inch	inch	psi
L5Y-4C	1/4" M.P.	0.75	1.18	1.00	0.87	0.68	20,000
L5Y-6C	3/8" M.P.	0.75	1.37	1.37	1.00	1.00	20,000
L5Y-9C	9/16" M.P.	1.00	1.75	1.75	1.25	1.25	20,000
L5Y-12C	3/4" M.P.	1.37	2.25	2.25	1.50	1.50	20,000
L5Y-16C	1" M.P.	1.75	3.00	3.00	2.06	2.06	20,000

## T5Y Medium Pressure Tee

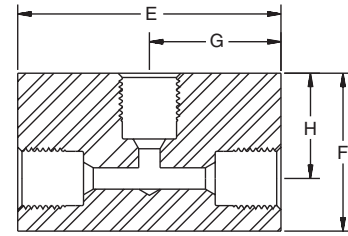

Part Number	Connection Type	Thickness	E	F	G	H	Maximum Working Pressure
#							
		inch	inch	inch	inch	inch	psi
T5Y-4C	1/4" M.P.	0.62	1.75	1.00	0.87	0.68	20,000
T5Y-6C	3/8" M.P.	0.75	2.00	1.37	1.00	1.00	20,000
T5Y-9C	9/16" M.P.	1.00	2.50	1.75	1.25	1.25	20,000
T5Y-12C	3/4" M.P.	1.37	3.00	2.25	1.50	1.50	20,000
T5Y-16C	1" M.P.	1.75	4.12	3.00	2.06	2.06	20,000

## X5Y Medium Pressure Cross

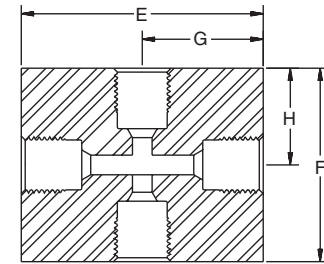

Part Number	Connection Type	Thickness	E	F	G	H	Maximum Working Pressure
#							
		inch	inch	inch	inch	inch	psi
X5Y-4C	1/4" M.P.	0.62	1.75	1.37	0.87	0.68	20,000
X5Y-6C	3/8" M.P.	0.75	2.00	2.00	1.00	1.00	20,000
X5Y-9C	9/16" M.P.	1.00	2.50	2.50	1.25	1.25	20,000
X5Y-12C	3/4" M.P.	1.37	3.00	3.00	1.50	1.50	20,000
X5Y-16C	1" M.P.	1.75	4.12	4.12	2.06	2.06	20,000

**Y2N**  
Medium Pressure  
Gland Nut

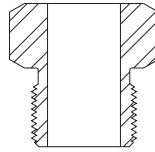

Part Number	Connection Type	Maximum Working Pressure
#		
		psi
Y2N-4C	1/4" M.P.	20,000
Y2N-6C	3/8" M.P.	20,000
Y2N-9C	9/16" M.P.	20,000
Y2N-12C	3/4" M.P.	20,000
Y2N-16C	1" M.P.	20,000

**Y2C**  
Medium Pressure Collar



Part Number	Connection Type	Maximum Working Pressure
#		
		psi
Y2C-4C	1/4" M.P.	20,000
Y2C-6C	3/8" M.P.	20,000
Y2C-9C	9/16" M.P.	20,000
Y2C-12C	3/4" M.P.	20,000
Y2C-16C	1" M.P.	20,000



**HBPLM**  
Medium Pressure Plug



Part Number	Connection Type	Maximum Working Pressure
#		
		psi
HBPLM4-B	1/4" M.P.	20,000
HBPLM6-B	3/8" M.P.	20,000
HBPLM9-B	9/16" M.P.	20,000
HBPLM12-B	3/4" M.P.	20,000
HBPLM16-B	1" M.P.	20,000

**Y204, Y206, Y209, Y212 and Y216**  
Medium Pressure Nipple

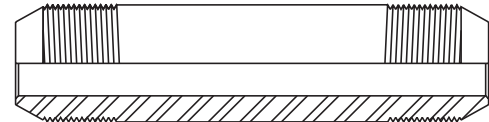

Length	1/4" O.D.	3/8" O.D.	9/16" O.D.	3/4" O.D.	1" O.D.
2.75"	Y204-0275C				
3"	Y204-0300C	Y206-0300C			
4"	Y204-0400C	Y206-0400C	Y209-0400C	Y212-0400C	
6"	Y204-0600C	Y206-0600C	Y209-0600C	Y212-0600C	Y216-0600C
8"	Y204-0800C	Y206-0800C	Y209-0800C	Y212-0800C	Y216-0800C
10"	Y204-1000C	Y206-1000C	Y209-1000C	Y212-1000C	Y216-1000C
12"	Y204-1200C	Y206-1200C	Y209-1200C	Y212-1200C	Y216-1200C

## High Pressure

### Sizes

1/4" O.D. x 0.08" I.D. • 9/16" - 18 male thread on gland nut  
3/8" O.D. x 0.12" I.D. • 3/4" - 16 male thread on gland nut  
9/16" O.D. x 0.18" I.D. • 1 1/8" - 12 male thread on gland nut

Identification is by tubing O.D.

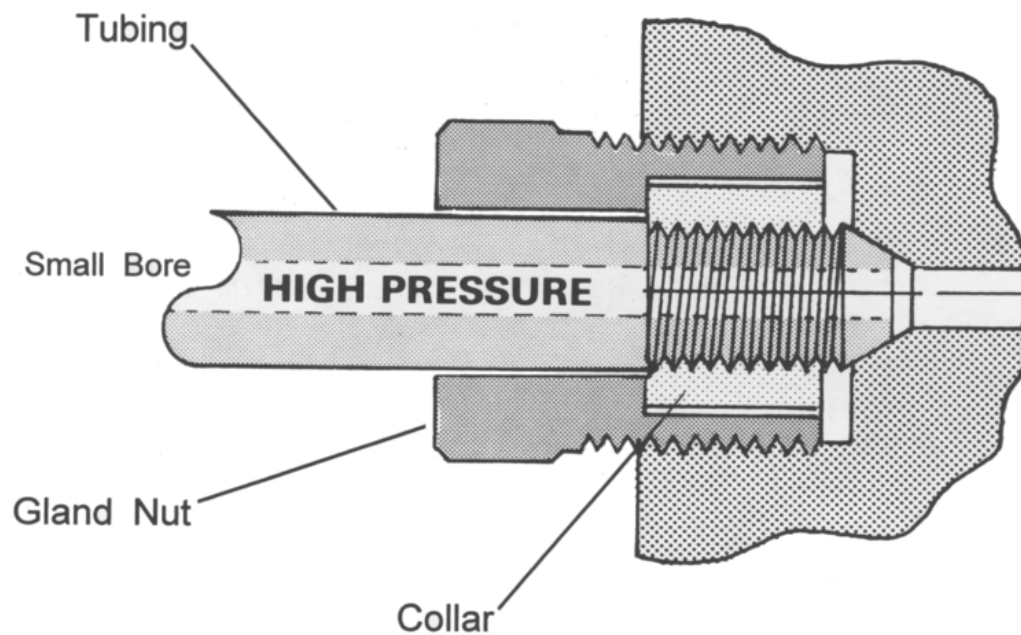

**High Pressure** is a 58/60 degree coned and threaded tubing design. *With small bore sizes, they have a maximum working pressure rating of 60,000 psi.*

### Advantages:

- An industry standard for use at elevated pressures.
- Suitable for repetitive assembly and disassembly.



## 6YY6

### Female High Pressure to Male High Pressure

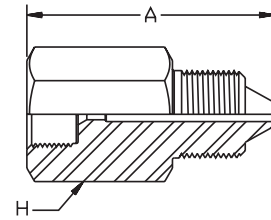

Part Number	Connection Type	A Overall Length	H Hex Size	Maximum Working Pressure
#				
		inch	inch	psi
6YY6-4-6C	1/4" H.P. Female to 3/8" H.P.	1.75	0.75	60,000
6YY6-4-9C	1/4" H.P. Female to 9/16" H.P.	2.12	1.12	60,000
6YY6-6-4C	3/8" H.P. Female to 1/4" H.P.	1.50	1.00	60,000
6YY6-6-9C	3/8" H.P. Female to 9/16" H.P.	2.12	1.12	60,000
6YY6-9-4C	9/16" H.P. Female to 1/4" H.P.	1.75	1.37	60,000
6YY6-9-6C	9/16" H.P. Female to 3/8" H.P.	1.87	1.37	60,000



## 6Y01

### Female High Pressure to Male NPT

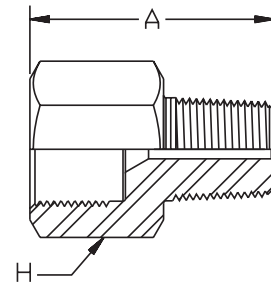



Part Number	Connection Type	A Overall Length	H Hex Size	Maximum Working Pressure
#				
		inch	inch	psi
6Y01-4-2C	1/4" H.P. to 1/8" NPT	1.25	0.75	15,000
6Y01-4-4C	1/4" H.P. to 1/4" NPT	1.37	0.75	15,000
6Y01-4-6C	1/4" H.P. to 3/8" NPT	1.37	0.75	15,000
6Y01-4-8C	1/4" H.P. to 1/2" NPT	1.75	1.00	15,000
6Y01-4-12C	1/4" H.P. to 3/4" NPT	1.75	1.37	10,000
6Y01-4-16C	1/4" H.P. to 1" NPT	1.62	1.37	10,000
6Y01-6-2C	3/8" H.P. to 1/8" NPT	1.50	1.00	15,000
6Y01-6-4C	3/8" H.P. to 1/4" NPT	1.62	1.00	15,000
6Y01-6-6C	3/8" H.P. to 3/8" NPT	1.62	1.00	15,000
6Y01-6-8C	3/8" H.P. to 1/2" NPT	1.75	1.00	15,000
6Y01-6-12C	3/8" H.P. to 3/4" NPT	1.87	1.37	10,000
6Y01-6-16C	3/8" H.P. to 1" NPT	1.87	1.37	10,000
6Y01-9-2C	9/16" H.P. to 1/8" NPT	1.50	1.37	15,000
6Y01-9-4C	9/16" H.P. to 1/4" NPT	1.62	1.27	15,000
6Y01-9-6C	9/16" H.P. to 3/8" NPT	1.75	1.37	15,000
6Y01-9-8C	9/16" H.P. to 1/2" NPT	1.87	1.37	15,000
6Y01-9-12C	9/16" H.P. to 3/4" NPT	1.87	1.37	10,000
6Y01-9-16C	9/16" H.P. to 1" NPT	2.00	1.37	10,000

## 02Y6

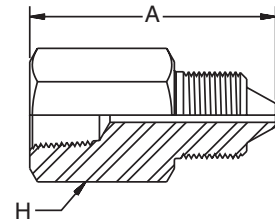
### Female NPT to Male High Pressure





Part Number	Connection Type	A Overall Length	H Hex Size	Maximum Working Pressure
#				
		inch	inch	psi
02Y6-2-4C	1/8" NPT to 1/4" H.P.	1.62	0.75	15,000
02Y6-2-6C	1/8" NPT to 3/8" H.P.	1.62	0.75	15,000
02Y6-2-9C	1/8" NPT to 9/16" H.P.	2.12	1.12	15,000
02Y6-4-4C	1/4" NPT to 1/4" H.P.	1.75	0.75	15,000
02Y6-4-6C	1/4" NPT to 3/8" H.P.	1.75	0.75	15,000
02Y6-4-9C	1/4" NPT to 9/16" H.P.	2.12	1.12	15,000
02Y6-6-4C	3/8" NPT to 1/4" H.P.	1.75	1.00	15,000
02Y6-6-6C	3/8" NPT to 3/8" H.P.	1.75	1.00	15,000
02Y6-6-9C	3/8" NPT to 9/16" H.P.	2.12	1.12	15,000
02Y6-8-4C	1/2" NPT to 1/4" H.P.	2.12	1.12	15,000
02Y6-8-6C	1/2" NPT to 3/8" H.P.	2.12	1.12	15,000
02Y6-8-9C	1/2" NPT to 9/16" H.P.	2.12	1.12	15,000
02Y6-12-6C	3/4" NPT to 3/8" H.P.	1.50	1.62	10,000
02Y6-12-9C	3/4" NPT to 9/16" H.P.	2.25	1.37	10,000
02Y6-16-9C	1" NPT to 9/16" H.P.	2.00	2.75	10,000

## Y6Y6

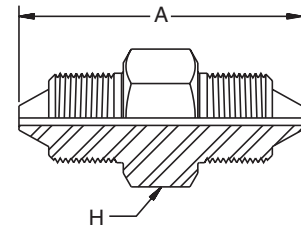
### Male High Pressure to Male High Pressure



Part Number	Connection Type	A Overall Length	H Hex Size	Maximum Working Pressure
#				
		inch	inch	psi
Y6Y6-4-4C	1/4" H.P. to 1/4" H.P.	1.68	0.62	60,000
Y6Y6-4-6C	1/4" H.P. to 3/8" H.P.	2.06	0.75	60,000
Y6Y6-4-9C	1/4" H.P. to 9/16" H.P.	2.25	1.12	60,000
Y6Y6-6-6C	3/8" H.P. to 3/8" H.P.	2.25	0.75	60,000
Y6Y6-6-9C	3/8" H.P. to 9/16" H.P.	2.50	1.12	60,000
Y6Y6-9-9C	9/16" H.P. to 9/16" H.P.	2.62	1.12	60,000

## Y601

### Male High Pressure to Male NPT

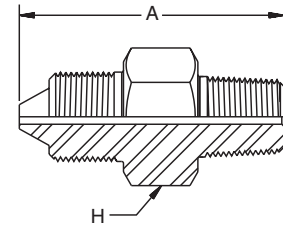

Part Number	Connection Type	A Overall Length	H Hex Size	Maximum Working Pressure
#				
		inch	inch	psi
Y601-4-2C	1/4" H.P. to 1/8" NPT	1.87	0.62	15,000
Y601-4-4C	1/4" H.P. to 1/4" NPT	2.06	0.75	15,000
Y601-4-6C	1/4" H.P. to 3/8" NPT	2.00	0.75	15,000
Y601-4-8C	1/4" H.P. to 1/2" NPT	2.12	0.87	15,000
Y601-4-12C	1/4" H.P. to 3/4" NPT	2.25	1.12	10,000
Y601-6-4C	3/8" H.P. to 1/4" NPT	2.12	0.87	15,000
Y601-6-6C	3/8" H.P. to 3/8" NPT	2.12	0.87	15,000
Y601-9-4C	9/16" H.P. to 1/4" NPT	2.37	1.12	15,000
Y601-9-6C	9/16" H.P. to 3/8" NPT	2.37	1.12	15,000
Y601-9-8C	9/16" H.P. to 1/2" NPT	2.50	1.12	15,000
Y601-9-12C	9/16" H.P. to 3/4" NPT	2.62	1.12	10,000
Y601-9-16C	9/16" H.P. to 1" NPT	2.75	1.37	10,000

C

## 6Y6Y

### Straight Coupling

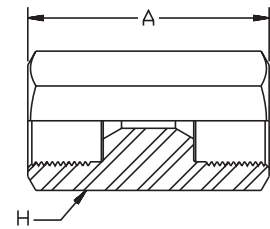

Part Number	Connection Type	A Overall Length	H Hex Size	Maximum Working Pressure
#				
		inch	inch	psi
6Y6Y-4-4C	1/4" H.P.	1.75	1.00	60,000
6Y6Y-6-6C	3/8" H.P.	2.00	1.00	60,000
6Y6Y-9-9C	9/16" H.P.	2.37	1.37	60,000

## 6Y6Y Reducer Coupling

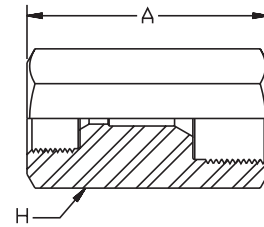

Part Number	Connection Type	A Overall Length	H Hex Size	Maximum Working Pressure
#				
		inch	inch	psi
6Y6Y-4-6C	1/4" H.P. to 3/8" H.P.	1.62	1.00	60,000
6Y6Y-4-9C	1/4" H.P. to 9/16" H.P.	1.75	1.37	60,000
6Y6Y-6-9C	3/8" H.P. to 9/16" H.P.	2.00	1.37	60,000

## 6Y02 Female High Pressure to Female NPT Coupling

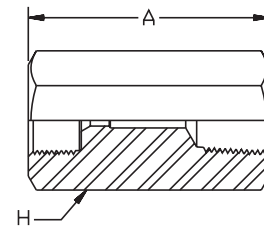

Part Number	Connection Type	A Overall Length	H Hex Size	Maximum Working Pressure
#				
		inch	inch	psi
6Y02-4-2C	1/4" H.P. to 1/8" NPT	1.50	1.00	15,000
6Y02-4-4C	1/4" H.P. to 1/4" NPT	1.50	1.00	15,000
6Y02-4-6C	1/4" H.P. to 3/8" NPT	1.87	1.00	15,000
6Y02-4-8C	1/4" H.P. to 1/2" NPT	1.87	1.12	15,000
6Y02-4-12C	1/4" H.P. to 3/4" NPT	2.00	1.62	10,000
6Y02-4-16C	1/4" H.P. to 1" NPT	2.50	1.75	10,000
6Y02-6-2C	3/8" H.P. to 1/8" NPT	1.87	1.00	15,000
6Y02-6-4C	3/8" H.P. to 1/4" NPT	1.87	1.00	15,000
6Y02-6-6C	3/8" H.P. to 3/8" NPT	1.87	1.00	15,000
6Y02-6-8C	3/8" H.P. to 1/2" NPT	1.87	1.12	15,000
6Y02-6-12C	3/8" H.P. to 3/4" NPT	2.12	1.37	10,000
6Y02-6-16C	3/8" H.P. to 1" NPT	2.50	1.75	10,000
6Y02-9-2C	9/16" H.P. to 1/8" NPT	2.37	1.37	15,000
6Y02-9-4C	9/16" H.P. to 1/4" NPT	2.37	1.37	15,000
6Y02-9-6C	9/16" H.P. to 3/8" NPT	2.37	1.37	15,000
6Y02-9-8C	9/16" H.P. to 1/2" NPT	2.37	1.37	15,000
6Y02-9-12C	9/16" H.P. to 3/4" NPT	2.37	1.37	10,000
6Y02-9-16C	9/16" H.P. to 1" NPT	2.62	2.00	10,000

## L6Y High Pressure Elbow

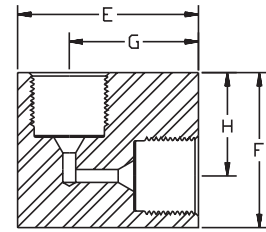

Part Number	Connection Type	Thickness	E	F	G	H	Maximum Working Pressure
#							
		inch	inch	inch	inch	inch	psi
L6Y-4C	1/4" H.P.	1.00	1.37	1.50	0.87	1.00	60,000
L6Y-6C	3/8" H.P.	1.00	1.75	1.50	1.25	1.00	60,000
L6Y-9C	9/16" H.P.	1.50	2.62	1.87	1.12	1.12	60,000



## T6Y High Pressure Tee

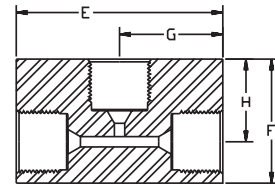

Part Number	Connection Type	Thickness	E	F	G	H	Maximum Working Pressure
#							
		inch	inch	inch	inch	inch	psi
T6Y-4C	1/4" H.P.	1.00	2.00	1.37	1.00	0.87	60,000
T6Y-6C	3/8" H.P.	1.00	2.00	1.56	1.00	1.06	60,000
T6Y-9C	9/16" H.P.	1.50	2.62	2.12	1.62	1.37	60,000

## X6Y High Pressure Cross

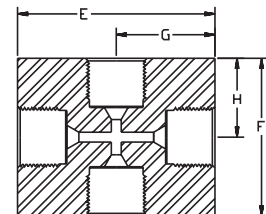

Part Number	Connection Type	Thickness	E	F	G	H	Maximum Working Pressure
#							
		inch	inch	inch	inch	inch	psi
X6Y-4C	1/4" H.P.	1.00	2.00	1.50	1.00	0.75	60,000
X6Y-6C	3/8" H.P.	1.00	2.12	2.00	1.06	1.00	60,000
X6Y-9C	9/16" H.P.	1.50	2.75	2.62	1.37	1.31	60,000

## Y4N High Pressure Gland Nut

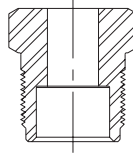

Part Number	Connection Type	Maximum Working Pressure
#		
		psi
Y4N-4C	1/4" H.P.	60,000
Y4N-6C	3/8" H.P.	60,000
Y4N-9C	9/16" H.P.	60,000

## Y4C High Pressure Collar

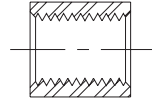

Part Number	Connection Type	Maximum Working Pressure
#		
		psi
Y4C-4C	1/4" H.P.	60,000
Y4C-6C	3/8" H.P.	60,000
Y4C-9C	9/16" H.P.	60,000

## HBPHM High Pressure Plug

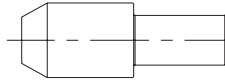

Part Number	Connection Type	Maximum Working Pressure
#		
		psi
HBPHM4-B	1/4" H.P.	60,000
HBPHM6-B	3/8" H.P.	60,000
HBPHM9-B	9/16" H.P.	60,000

## Nipples High Pressure



Length	1/4" O.D.	3/8" O.D.	9/16" O.D.
2.75"	Y404-0275C	—	—
3"	Y404-0300C	Y406-0300C	—
4"	Y404-0400C	—	Y409-0400C
6"	Y404-0600C	Y406-0600C	Y409-0600C
8"	Y404-0800C	Y406-0800C	Y409-0800C
10"	Y404-1000C	Y406-1000C	Y409-1000C
12"	Y404-1200C	Y406-1200C	Y409-1200C

## Locking Nut/Collar Anti-Vibration

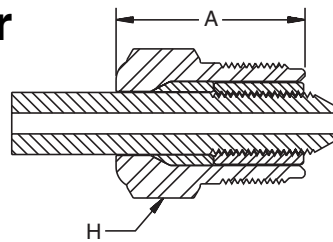

Locking Nut and Collar Part Number	Tube O.D.	A Length	H Hex Size
#			
	inch	inch	inch
Y4NC-4C-AV	1/4" H.P.	0.68	0.63
Y4NC-6C-AV	3/8" H.P.	1.06	0.68
Y4NC-9C-AV	9/16" H.P.	1.56	1.68

## National Pipe Tapered (NPT)

**polyflex**<sup>™</sup> offers a broad range of high quality stainless steel high pressure NPT adapters. Sizes 1/8" to 1/2" are rated up to 15,000 psi, 3/4" and above are rated to 10,000 psi.



**C**

### K0202 NPT Coupler

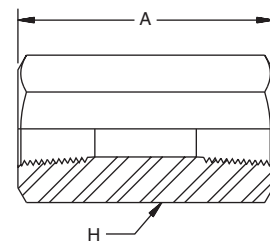

Part Number	Connection Type	A Overall Length	H Hex Size	Maximum Working Pressure
#				
		inch	inch	psi
10K0202-12-12C	3/4" NPT Female	2.13	1.50	10,000
10K0202-16-16C	1" NPT Female	2.50	2.00	10,000
15K0202-2-2C	1/8" NPT Female	1.50	0.75	15,000
15K0202-4-4C	1/4" NPT Female	1.75	0.87	15,000
15K0202-6-6C	3/8" NPT Female	1.75	1.00	15,000
15K0202-8-8C	1/2" NPT Female	2.13	1.25	15,000

### KL02 NPT Elbow

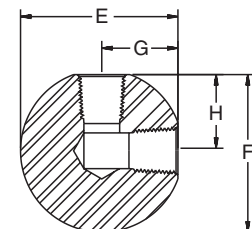

Part Number	Connection Type	Thickness	E	F	G	H	Maximum Working Pressure
#							
		inch	inch	inch	inch	inch	psi
10KL02-12C	3/4" NPT Female	2.05	1.85	1.85	1.35	1.35	10,000
10KL02-16C	1" NPT Female	2.50	3.83	3.83	1.82	1.82	10,000
15KL02-4C	1/4" NPT Female	1.15	1.70	1.70	0.80	0.80	15,000
15KL02-6C	3/8" NPT Female	1.38	1.90	1.90	0.90	0.90	15,000
15KL02-8C	1/2" NPT Female	1.63	2.15	2.15	1.03	1.03	15,000

**KX02**  
NPT Cross

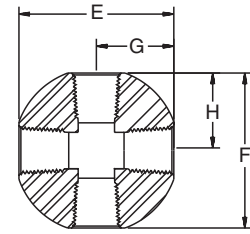

Part Number	Connection Type	Thickness	E	F	G	H	Maximum Working Pressure
#							
		inch	inch	inch	inch	inch	psi
10KX02-12C	3/4" NPT Female	2.05	2.70	2.70	1.35	1.35	10,000
10KX02-16C	1" NPT Female	2.50	3.63	3.63	1.82	1.82	10,000
15KX02-4C	1/4" NPT Female	1.15	1.60	1.60	0.80	0.80	15,000
15KX02-6C	3/8" NPT Female	1.38	1.80	1.80	0.90	0.90	15,000
15KX02-8C	1/2" NPT Female	1.63	2.05	2.05	1.03	1.03	15,000

**KT02**  
NPT Tee

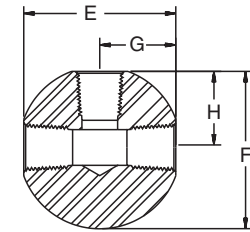



Part Number	Connection Type	Thickness	E	F	G	H	Maximum Working Pressure
#							
		inch	inch	inch	inch	inch	psi
10KT02-12C	3/4" NPT Female	2.05	2.70	1.85	1.35	2.05	10,000
10KT02-16C	1" NPT Female	2.50	3.63	3.83	1.82	2.50	10,000
15KT02-4C	1/4" NPT Female	1.15	1.60	1.70	0.80	1.15	15,000
15KT02-6C	3/8" NPT Female	1.38	1.80	1.90	0.90	1.38	15,000
15KT02-8C	1/2" NPT Female	1.63	2.05	2.15	1.03	1.63	15,000

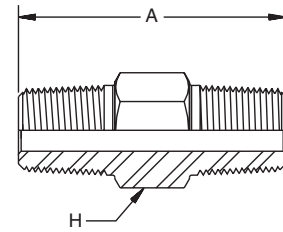

## K0101 NPT Nipple





Part Number	Connection Type	A Overall Length	H Hex Size	Maximum Working Pressure
#				
		inch	inch	psi
10K0101-12-12C	3/4" NPT Male	2.44	1.13	10,000
10K0101-16-16C	1" NPT Male	2.75	1.38	10,000
15K0101-1-1C	1/16" NPT Male	1.00	0.38	15,000
15K0101-2-2C	1/8" NPT Male	1.20	0.50	15,000
15K0101-4-4C	1/4" NPT Male	1.44	0.63	15,000
15K0101-6-6C	3/8" NPT Male	1.70	0.75	15,000
15K0101-8-8C	1/2" NPT Male	2.25	1.00	15,000

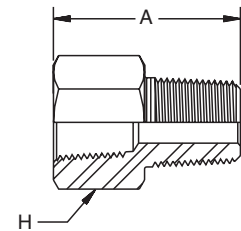

## K0201 NPT Reducer Bushing



Part Number	Connection Type	A Overall Length	H Hex Size	Maximum Working Pressure
#				
		inch	inch	psi
15K0201-1-8C	1/16" NPT Female to 1/2" NPT Male	1.25	0.87	15,000
15K0201-2-8C	1/8" NPT Female to 1/2" NPT Male	1.25	0.87	15,000
15K0201-4-8C	1/4" NPT Female to 1/2" NPT Male	1.25	0.87	15,000
15K0201-6-8C	3/8" NPT Female to 1/2" NPT Male	1.63	1.00	15,000

## Valves

**Medium Pressure —up to 20,000 psi**  
**High Pressure —up to 60,000 psi**

Developed to assure safe and easy plumbing through 60,000 psi. These needle valves are engineered to the highest standards of repeatable quality. The medium pressure valves are designed with a compact cone-and-threaded connection which permits the larger bore sizes and increased flow rates common in this pressure class. The high pressure valves also use a coned-and-threaded connection which accommodates the high pressures common in these applications.

Non-rotating tip stems are standard for on-off service and insure long life on valve seats.

Materials include high tensile type 316 stainless steel bodies and hardened 17-4PH stainless steel lower section stems.

Packing is TFE standard with optional Viton®, BUNA-N and Grafoil available as non-standard.

Two Way Straight valves are standard with five additional patterns to satisfy widely varied requirements are available on request.

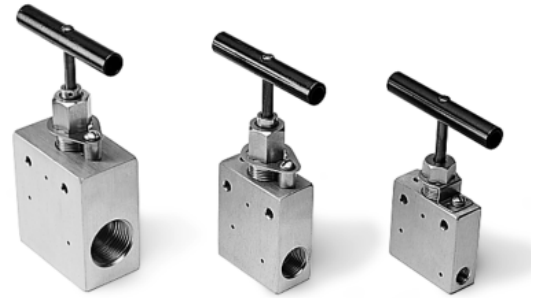

### Features:

- Non-Rotating Stem Tips
- Packing Below Stem Threads
- Type 316 ss high tensile bodies
- Positive gland lock device
- No stem adjustment needed
- Black T-handles standard or choice of 4 colors (special order)
- Tube sizes  
Medium Pressure — 1/4" through 1"  
High Pressure — 1/4" through 9/16"

## SV5Y

### Two Way Straight Valves

#### Medium Pressure —20,000 psi

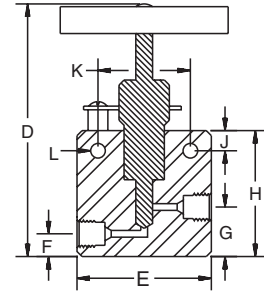

Part Number	Connection Type	Orifice	Thickness	D	E	F	G	H	J	K	L	Maximum Working Pressure
#												
				inch	inch	inch	inch	inch	inch	inch	inch	psi
SV5Y-12C-20	3/4" Medium Pressure	0.51	1.37	7.00	3.00	0.75	1.50	3.75	0.62	1.75	0.43	20,000
SV5Y-16C-20	1" Medium Pressure	0.68	1.75	8.42	4.12	0.87	1.81	4.62	1.12	2.50	0.56	20,000
SV5Y-4C-20	1/4" Medium Pressure	0.10	0.75	4.37	2.00	0.37	0.81	2.00	0.37	1.25	0.21	20,000
SV5Y-6C-20	3/8" Medium Pressure	0.20	0.75	4.37	2.00	0.37	0.81	2.00	0.37	1.25	0.21	20,000
SV5Y-9C-20	9/16" Medium Pressure	0.31	1.00	6.12	2.50	0.50	1.12	2.87	0.50	1.37	0.34	20,000

**AV5Y**  
Two Way Angle Valves  
Medium Pressure – 20,000 psi

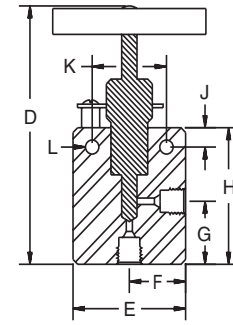

Part Number	Connection Type	Orifice	Thickness	D	E	F	G	H	J	K	L	Maximum Working Pressure
#												
				inch	inch	inch	inch	inch	inch	inch	inch	psi
AV5Y-4C-20	1/4" Medium Pressure	0.10	0.75	4.81	2.00	1.00	1.25	2.43	0.37	1.25	0.21	20,000
AV5Y-6C-20	3/8" Medium Pressure	0.20	0.75	4.81	2.00	1.00	1.25	2.43	0.37	1.25	0.21	20,000
AV5Y-9C-20	9/16" Medium Pressure	0.31	1.00	6.62	2.50	1.25	1.62	3.37	0.50	1.37	0.34	20,000
AV5Y-12C-20	3/4" Medium Pressure	0.51	1.37	7.50	3.00	1.50	2.00	4.25	0.62	1.75	0.43	20,000
AV5Y-16C-20	1" Medium Pressure	0.68	1.75	9.37	4.12	2.06	2.56	5.43	1.12	2.50	0.56	20,000



**TV25Y**  
Three Way Valves  
Medium Pressure – 20,000 psi  
Two Pressure Connections

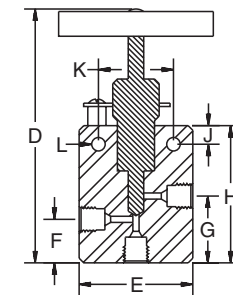

Part Number	Connection Type	Orifice	Thickness	D	E	F	G	H	J	K	L	Maximum Working Pressure
#												
				inch	inch	inch	inch	inch	inch	inch	inch	psi
TV25Y-4C-20	1/4" Medium Pressure	0.10	0.75	5.00	2.00	1.00	1.43	2.62	0.37	1.25	0.21	20,000
TV25Y-6C-20	3/8" Medium Pressure	0.20	0.75	5.00	2.00	1.00	1.43	2.62	0.37	1.25	0.21	20,000
TV25Y-9C-20	9/16" Medium Pressure	0.31	1.00	6.87	2.50	1.25	1.87	3.62	0.50	1.37	0.34	20,000
TV25Y-12C-20	3/4" Medium Pressure	0.51	1.37	7.87	3.00	2.62	2.37	4.62	0.62	1.75	0.43	20,000
TV25Y-16C-20	1" Medium Pressure	0.68	1.75	9.75	4.12	2.12	3.06	5.87	1.12	2.50	0.56	20,000

## TV15Y

Three Way Valves  
Medium Pressure – 20,000 psi  
One Pressure Connection

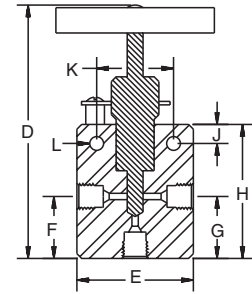

Part Number	Connection Type	Orifice	Thickness	D	E	F	G	H	J	K	L	Maximum Working Pressure
#												
				inch	inch	inch	inch	inch	inch	inch	inch	psi
TV15Y-4C-20	1/4" Medium Pressure	0.10	0.75	4.81	2.00	1.25	1.25	2.43	0.37	1.25	0.21	20,000
TV15Y-6C-20	3/8" Medium Pressure	0.20	0.75	4.81	2.00	1.25	1.25	2.43	0.37	1.25	0.21	20,000
TV15Y-9C-20	9/16" Medium Pressure	0.31	1.00	6.62	2.50	1.62	1.62	3.37	0.50	1.37	0.34	20,000
TV15Y-12C-20	3/4" Medium Pressure	0.51	1.37	7.50	3.00	2.00	2.00	4.25	0.62	1.75	0.43	20,000
TV15Y-16C-20	1" Medium Pressure	0.68	1.75	9.37	4.12	2.62	2.62	5.43	1.12	2.50	0.56	20,000

## CV5Y

Ball Check Valves  
Medium Pressure

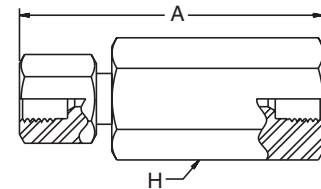

Part Number	Connection Type	A Overall Length	H Hex Size	Maximum Working Pressure
#				
		inch	inch	psi
CV5Y-4C-20	1/4" Medium pressure	3.75	1.00	20,000
CV5Y-6C-20	3/8" Medium Pressure	3.75	1.00	20,000
CV5Y-9C-20	9/16" Medium Pressure	0.35	1.37	20,000

**SV6Y**  
Two Way Straight Valves  
High Pressure – 30,000 psi

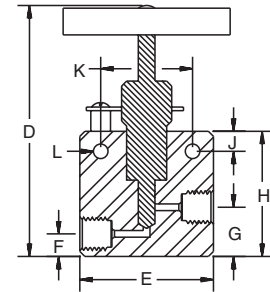

Part Number	Connection Type	Orifice	Thickness	D	E	F	G	H	J	K	L	Maximum Working Pressure
#				inch	inch	inch	inch	inch	inch	inch	inch	psi
SV6Y-4C-30	1/4" High pressure	0.09	1.00	5.18	2.00	0.62	1.00	2.43	0.50	1.37	0.21	30,000
SV6Y-6C-30	3/8" High Pressure	0.12	1.00	5.18	2.00	0.62	1.00	2.43	0.50	1.37	0.21	30,000
SV6Y-9C-30	9/16" High Pressure	0.12	1.50	5.62	2.62	1.00	1.43	2.87	0.50	1.37	0.21	30,000



**AV6Y**  
Two Way Angle Valves  
High Pressure – 30,000 psi

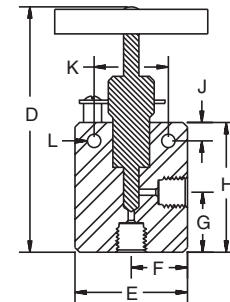

Part Number	Connection Type	Orifice	Thickness	D	E	F	G	H	J	K	L	Maximum Working Pressure
#				inch	inch	inch	inch	inch	inch	inch	inch	psi
AV6Y-4C-30	1/4" High pressure	0.09	1.00	5.18	2.00	1.00	1.00	2.43	0.50	1.37	0.21	30,000
AV6Y-6C-30	3/8" High Pressure	0.12	1.00	5.56	2.00	1.00	1.37	2.81	0.50	1.37	0.21	30,000
AV6Y-9C-30	9/16" High Pressure	0.12	1.50	5.62	2.62	1.31	1.43	2.87	0.50	1.37	0.21	30,000

## TV26Y

Three Way Valves  
High Pressure – 30,000 psi  
Two Pressure Connections

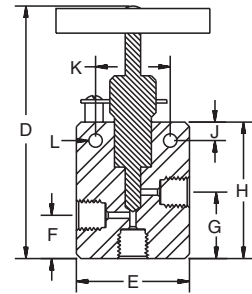

Part Number	Connection Type	Orifice	Thickness	D	E	F	G	H	J	K	L	Maximum Working Pressure
#												
				inch	inch	inch	inch	inch	inch	inch	inch	psi
TV26Y-4C-30	1/4" High pressure	0.09	1.00	5.18	2.00	0.62	1.00	2.43	0.50	1.37	0.21	30,000
TV26Y-6C-30	3/8" High Pressure	0.12	1.00	5.56	2.00	1.00	1.37	2.81	0.50	1.37	0.21	30,000
TV26Y-9C-30	9/16" High Pressure	0.12	1.50	6.06	2.62	1.43	1.87	3.31	0.50	1.37	0.21	30,000

## TV16Y

Three Way Valves  
High Pressure – 30,000 psi  
One Pressure Connection

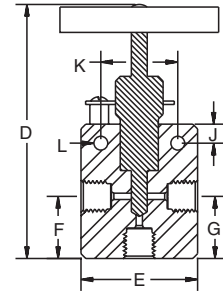

Part Number	Connection Type	Orifice	Thickness	D	E	F	G	H	J	K	L	Maximum Working Pressure
#												
				inch	inch	inch	inch	inch	inch	inch	inch	psi
TV16Y-4C-30	1/4" High pressure	0.09	1.00	5.18	2.00	1.00	1.00	2.43	0.50	1.37	0.21	30,000
TV16Y-6C-30	3/8" High Pressure	0.12	1.00	5.56	2.00	2.00	1.43	2.81	0.50	1.37	0.21	30,000
TV16Y-9C-30	9/16" High Pressure	0.12	1.50	5.62	2.62	2.18	1.43	2.87	0.50	1.37	0.21	30,000

**SV6Y**  
Two Way Straight Valves  
High Pressure – 60,000 psi

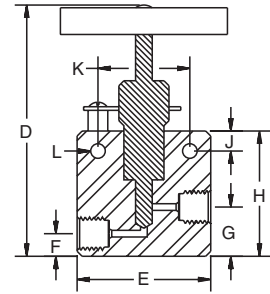

Part Number	Connection Type	Orifice	Thickness	D	E	F	G	H	J	K	L	Maximum Working Pressure
#												
				inch	inch	inch	inch	inch	inch	inch	inch	psi
SV6Y-4C-60	1/4" High pressure	0.06	1.00	5.18	2.00	0.62	1.00	2.43	0.50	1.37	0.21	60,000
SV6Y-6C-60	3/8" High Pressure	0.06	1.00	5.18	2.00	0.62	1.00	2.43	0.50	1.37	0.21	60,000
SV6Y-9C-60	9/16" High Pressure	0.06	1.50	5.62	2.62	1.00	1.43	2.87	0.50	1.37	0.21	60,000



**AV6Y**  
Two Way Angle Valves  
High Pressure – 60,000 psi

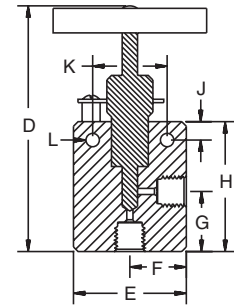

Part Number	Connection Type	Orifice	Thickness	D	E	F	G	H	J	K	L	Maximum Working Pressure
#												
				inch	inch	inch	inch	inch	inch	inch	inch	psi
AV6Y-4C-60	1/4" High pressure	0.06	1.00	5.18	2.00	1.00	1.00	2.43	0.50	1.37	0.21	60,000
AV6Y-6C-60	3/8" High Pressure	0.06	1.00	5.56	2.00	1.00	1.37	2.81	0.50	1.37	0.21	60,000
AV6Y-9C-60	9/16" High Pressure	0.06	1.50	5.62	2.62	1.31	1.43	2.87	0.50	1.37	0.21	60,000

## TV26Y

Three Way Valves  
High Pressure – 60,000 psi  
Two Pressure Connections

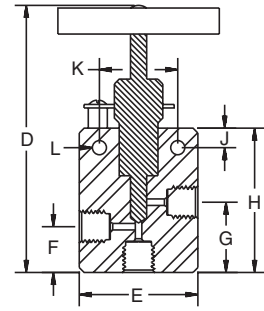

Part Number	Connection Type	Orifice	Thickness	D	E	F	G	H	J	K	L	Maximum Working Pressure
#												
				inch	inch	inch	inch	inch	inch	inch	inch	psi
TV26Y-4C-60	1/4" High pressure	0.06	1.00	5.18	2.00	0.62	1.00	2.43	0.50	1.37	0.21	60,000
TV26Y-6C-60	3/8" High Pressure	0.06	1.00	5.56	2.00	1.00	1.37	2.81	0.50	1.37	0.21	60,000
TV26Y-9C-60	9/16" High Pressure	0.06	1.50	6.06	2.62	1.43	1.87	3.31	0.50	1.37	0.21	60,000

## TV16Y

Three Way Valves  
High Pressure – 60,000 psi  
One Pressure Connection

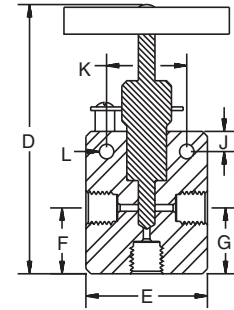

Part Number	Connection Type	Orifice	Thickness	D	E	F	G	H	J	K	L	Maximum Working Pressure
#												
				inch	inch	inch	inch	inch	inch	inch	inch	psi
TV16Y-4C-60	1/4" High pressure	0.06	1.00	5.18	2.00	1.00	1.00	2.43	0.50	1.37	0.21	60,000
TV16Y-6C-60	3/8" High Pressure	0.06	1.00	5.56	2.00	2.00	1.43	2.81	0.50	1.37	0.21	60,000
TV16Y-9C-60	9/16" High Pressure	0.06	1.50	5.62	2.62	2.18	1.43	2.87	0.50	1.37	0.21	60,000

## CV6Y

Ball Check Valves  
High Pressure

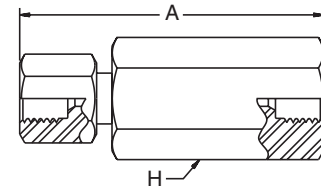

Part Number	Connection Type	A Overall Length	H Hex Size	Maximum Working Pressure
#				
		inch	inch	psi
CV6Y-4C-60	1/4" High pressure	4.18	1.50	60,000
CV6Y-6C-60	3/8" High Pressure	4.25	1.50	60,000
CV6Y-9C-60	9/16" High Pressure	4.62	1.56	60,000



**Table of Contents**

**Rogan Series —**

**30,000 psi Maximum Working Pressure**

HP006 Coupler ..... D3  
 HP006 Nipple (without Check Valve) ..... D4  
 HP006 Nipple (with Check Valve) ..... D5  
 HP010 Coupler ..... D6  
 HP010 Nipple (without Check Valve) ..... D7  
 HP010 Nipple (with Check Valve) ..... D8

**C Series Hydraulic Couplers —**

**29,800 psi Maximum Working Pressure**

115 Coupler ..... D10  
 115 Nipple ..... D11  
 116 Coupler ..... D12  
 116 Nipple ..... D13  
 125 Coupler ..... D13  
 125 Nipple ..... D14  
 Adapters ..... D15

**WB Series Waterblast Couplers —**

**10,000 psi Maximum Working Pressure**

WB Coupler ..... D17  
 WB Nipple ..... D17



## Rogan Series

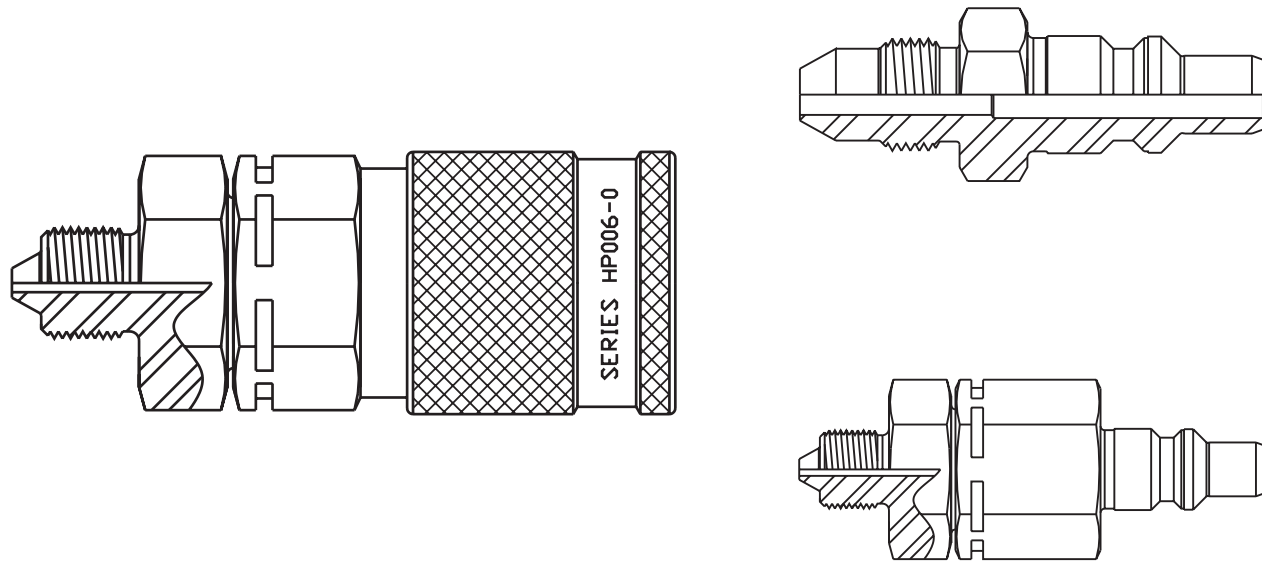



A versatile connecting device that permits easy and rapid joining of hose assemblies to your system. Each coupling is assembled and pressure tested to at least 5,000 psi above its maximum rated working pressure. Couplings with check-valve can withstand the full working pressure in the disconnected condition.

Type	Max. Working Pressure (psi)	Test Pressure (psi)	Nominal Thru Hole Diameter (in)
HP006	30,000	35,000	0.24
HP010	20,000	25,000	0.40

**NOTE:** The choice of the threaded end form may limit the working pressure and the size of the thru hole in the coupling. Call **polyflex™** for additional information.

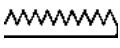
# HP006 Coupler

Part Number	Connection Type	A Overall Length	H Hex Size	Maximum Working Pressure
#				
		inch	inch	psi
HP006-0-A9	Type "M" (9/16" - 18 threads)	3.30	1.19	30,000
HP006-0-A12	Type "M" (3/4" - 16 threads)	3.34	1.19	30,000
HP006-0-HM4	1/4" High Pressure Male	3.46	1.19	30,000
HP006-0-HM9	9/16" High Pressure Male	3.70	1.19 </td <td>30,000</td>	30,000
HP006-0-LM6	3/8" Medium Pressure Male	3.54	1.19	20,000
HP006-0-NFB	1/4" NPT Female	3.30	1.19	15,000
HP006-0-NFC	3/8" NPT Female	3.30	1.19	15,000
HP006-0-NMB	1/4" NPT Male	3.40	1.19	15,000
HP006-0-NMC	3/8" NPT Male	3.30	1.19	15,000
HP006-0-NMD	1/2" NPT Male	3.45	1.19	15,000
HP006-0-X13	Low Angle Face Seal (9/16" - 18 threads)	3.37	1.19	30,000

**D**

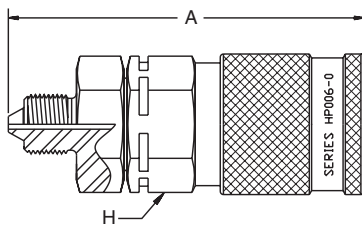

**HP006-0-HM4**

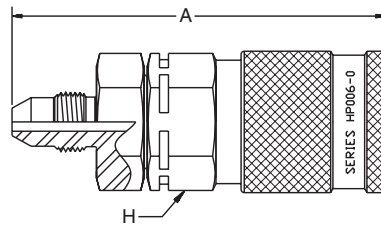

**HP006-0-LM6**

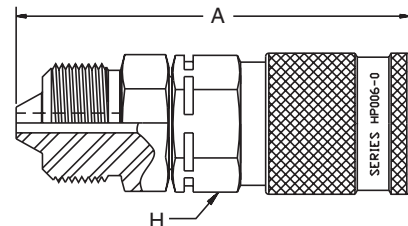

**HP006-0-HM9**

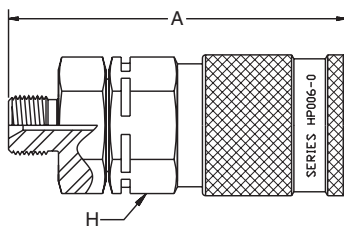

**HP006-0-A9,  
HP006-0-A12**

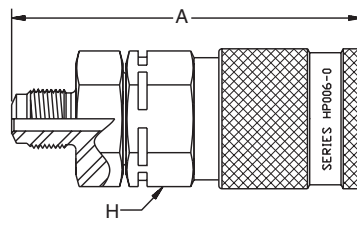

**HP006-0-X13**

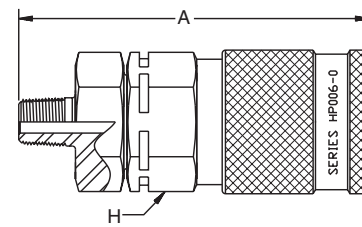

**HP006-0-NMB,  
HP006-0-NMC,  
HP006-0-NMD**

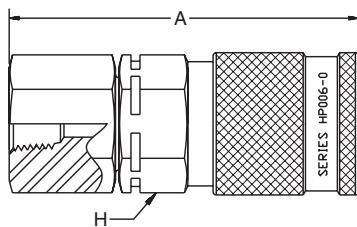



**HP006-0-NFB,  
HP006-0-NFC**

# HP006

## Nipple

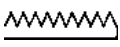
### Without Check Valve

Part Number	Connection Type	A Overall Length	H Hex Size	Maximum Working Pressure
#				
		inch	inch	psi
HP006-1-A9	Type "M" (9/16" - 18 threads)	1.98	0.75	30,000
HP006-1-A12	Type "M" (3/4" - 16 threads)	2.16	0.87	30,000
HP006-1-HM4	1/4" High Pressure Male	2.25	0.75	30,000
HP006-1-LM6	3/8" Medium Pressure Male	2.33	0.75	20,000
HP006-1-LM9	9/16" Medium Pressure Male	2.57	1.00	20,000
HP006-1-NMB	1/4" NPT Male	2.09	0.75	15,000
HP006-1-NMC	3/8" NPT Male	2.13	0.75	15,000
HP006-1-NMD	1/2" NPT Male	2.31	1.00	15,000
HP006-1-X13	Low Angle Face Seal (9/16" - 18 threads)	2.17	0.75	30,000

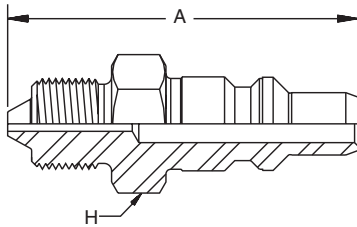

**HP006-1-HM4**

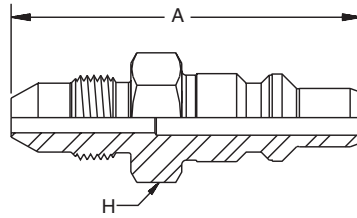

**HP006-1-LM6,  
 HP006-1-LM9**

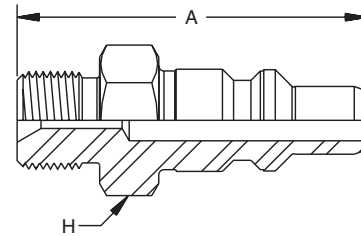

**HP006-1-A9,  
 HP006-1-A12**

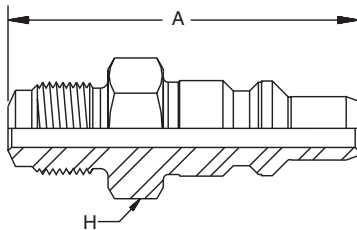

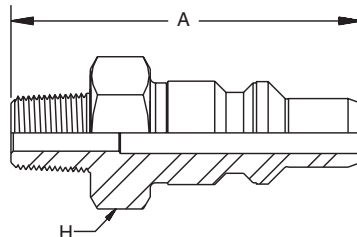

**HP006-1-X13**



**HP006-1-NMB,  
 HP006-1-NMC,  
 HP006-1-NMD**

# HP006

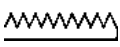
## Nipple With Check Valve

Part Number	Connection Type	A Overall Length	H Hex Size	Maximum Working Pressure
#				
		inch	inch	psi
HP006-2-A9	Type "M" (9/16" - 18 threads)	3.28	1.19	30,000
HP006-2-A12	Type "M" (3/4" - 16 threads)	3.30	1.19	30,000
HP006-2-HM4	1/4" High Pressure Male	3.45	1.19	30,000
HP006-2-LM6	3/8" Medium Pressure Male	3.52	1.19	20,000
HP006-2-NFB	1/4" NPT Female	3.26	1.19	15,000
HP006-2-NFC	3/8" NPT Female	3.25	1.19	15,000
HP006-2-NMB	1/4" NPT Male	3.34	1.19	15,000
HP006-2-NMC	3/8" NPT Male	3.34	1.19	15,000
HP006-2-NMD	1/2" NPT Male	3.43	1.19	15,000
HP006-2-X13	Low Angle Face Seal (9/16" - 18 threads)	3.35	1.19	30,000

**D**

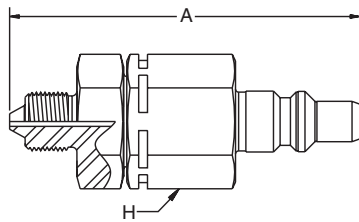

**HP006-2-HM4**

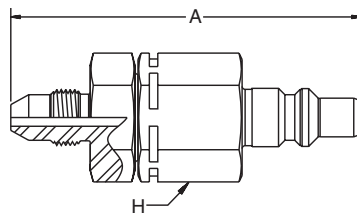

**HP006-2-LM6**

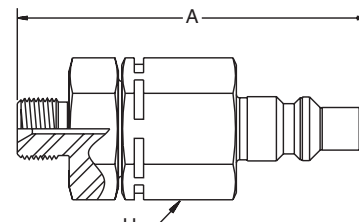

**HP006-2-A9,  
HP006-2-A12**

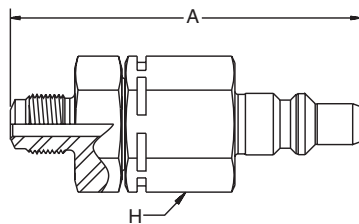

**HP006-2-X13**

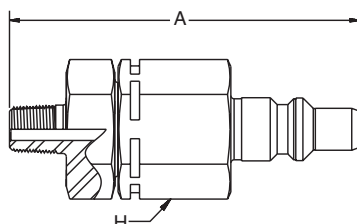

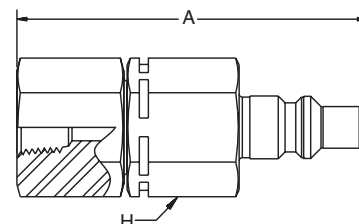

**HP006-2-NMB,  
HP006-2-NMC,  
HP006-2-NMB**



**HP006-2-NFB,  
HP006-2-NFC**

# HP010

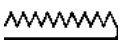
## Coupler

Part Number	Connection Type	A Overall Length	H Hex Size	Maximum Working Pressure
#				
		inch	inch	psi
HP010-0-A12	Type "M" ( 3/4" - 16 threads)	4.00	1.62	20,000
HP010-0-A16	Type "M" (1" - 12 threads)	4.10	1.62	20,000
HP010-0-LM12	3/4" Medium Pressure Male	4.64	1.62	20,000
HP010-0-NFD	1/2" NPT Female	4.27	1.62	15,000
HP010-0-NMD	1/2" NPT Male	4.13	1.62	15,000
HP010-0-X23	Low Angle Face Seal (3/4" - 16 threads)	4.19	1.62	20,000

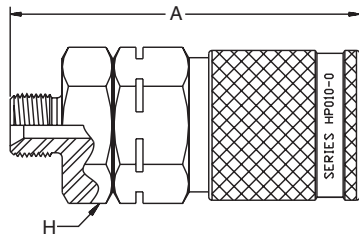

**HP010-0-A12,  
 HP010-0-A16**

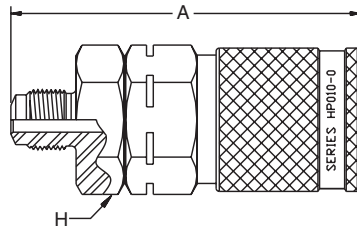

**HP010-0-X23**

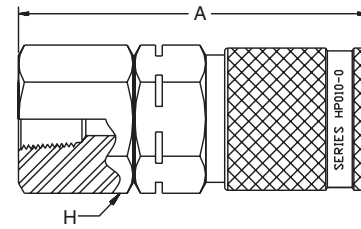

**HP010-0-NFD**

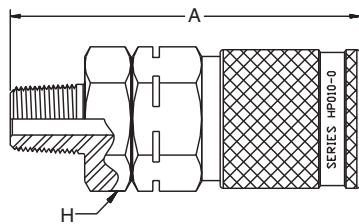

**HP010-0-NMD**

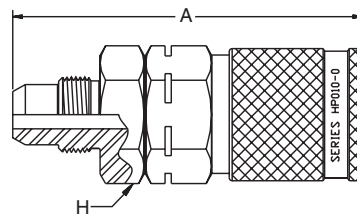



**HP010-0-LM12**

# HP010

## Nipple

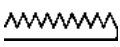
### Without Check Valve

Part Number	Connection Type	A Overall Length	H Hex Size	Maximum Working Pressure
#				
		inch	inch	psi
HP010-1-A12	Type "M" (3/4" - 16 threads)	2.40	1.06	20,000
HP010-1-A16	Type "M" (1" - 12 threads)	2.53	1.18	20,000
HP010-1-LM12	3/4" Medium Pressure Male	3.12	1.18	20,000
HP010-1-LM9	9/16" Medium Pressure Male	2.84	1.06	20,000
HP010-1-NMD	1/2" NPT Male	2.52	1.06	15,000
HP010-1-X23	Low Angle Face Seal (3/4" - 16 threads)	2.58	1.06	20,000

**D**

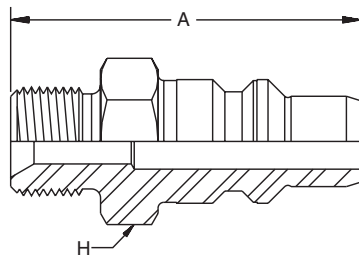

**HP010-1-A12,  
HP010-1-A16**

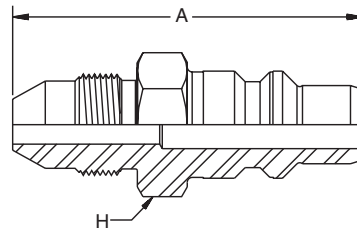

**HP010-1-LM9,  
HP010-1-LM12**

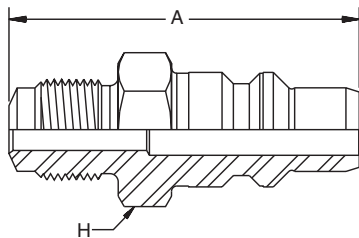

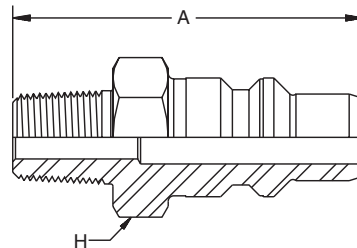

**HP010-1-X23**



**HP010-1-NMD**

# HP010

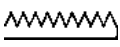
## Nipple With Check Valve

Part Number	Connection Type	A Overall Length	H Hex Size	Maximum Working Pressure
#				
		inch	inch	psi
HP010-2-A12	Type "M" (3/4" - 16 threads)	4.00	1.62	20,000
HP010-2-A16	Type "M" (1" - 12 threads)	4.08	1.62	20,000
HP010-2-NFD	1/2" NPT Female	4.14	1.62	15,000
HP010-2-NMD	1/2" NPT Male	4.13	1.62	15,000
HP010-2-X23	Low Angle Face Seal (3/4" - 16 threads)	4.18	1.62	20,000

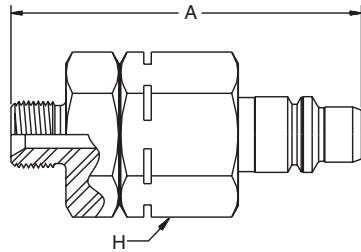

**HP010-2-A12,  
 HP010-2-A16**

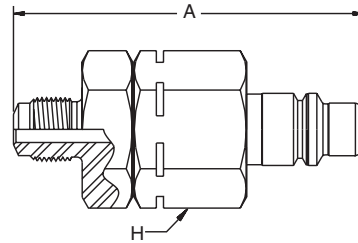

**HP010-2-X23**

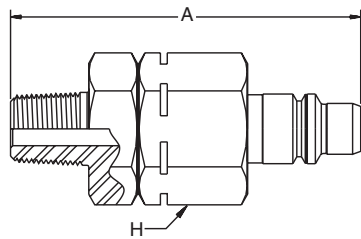

**HP010-2-NMD**

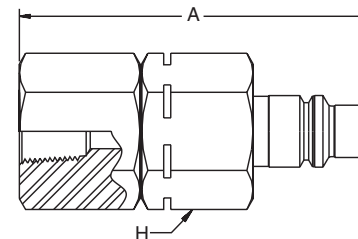

**HP010-2-NFD**



## C Series

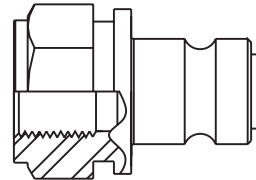
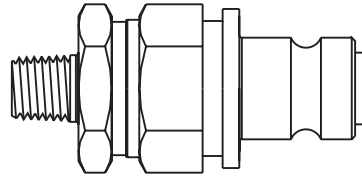
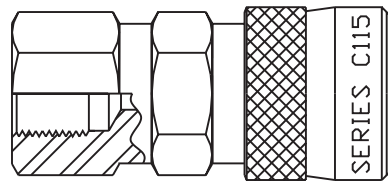

### Features:

- Working pressures to 29,000 psi.
- Non-drip valving for clean, safe, trouble-free performance and minimal air inclusion.
- Built-in safety locking device to prevent accidental disconnect.
- Wide range of threaded styles NPT, BSP and “High Pressure”.
- Adaptors for ease of connection to high pressure hoses and fixed ports.
- Thread sizes from 1/8" to 3/8"
- Protective dust caps are included to prevent damage and fluid contamination in disconnected position.
- Rugged design and construction for long life in demanding applications.

### Applications:



- Torque Tensioning
- Stud Tensioning
- Rescue
- Bearing Pullers
- Intensifiers
- Hydrostatic Testing
- Pumps
- Jacks
- Spreaders
- Cable Cutters
- Nut Splitters
- Pipe Coupling Swagers
- Presses
- Clamping Fictures
- Crimpers
- Blow-out Preventers

Type	Max. Working Pressure (psi)	Test Pressure (psi)	Nominal Thru Hole Diameter (in.)
C Series 115	14,500	21,800	0.11
C Series 116	21,800	29,200	0.11
C Series 125	29,800	36,300	0.11

**NOTE:** The choice of the threaded end form may limit the working pressure and the size of the thru hole in the coupling.

# 115

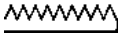
## Coupler

Part Number	Connection Type	A Overall Length	H Hex Size	Maximum Working Pressure
#				
		inch	inch	psi
C10-115-1202	1/4" BSP Female (thru type)	2.30	0.94	14,500
C10-115-1222	1/4" BSP Female (with built-in locking device)	2.30	0.94	14,500
C10-115-1401	1/8" NPT Female	2.30	0.94	14,500
C10-115-1402	1/4" NPT Female	2.30	0.94	14,500
C10-115-1404	3/8" NPT Female	2.38	0.94	14,500
C10-115-1422	1/4" NPT Female (with built-in locking device)	2.30	0.94	14,500
C10-115-1452	1/4" NPT Male	2.45	0.94	14,500
C10-115-1454	3/8" NPT Male	2.45	0.94	14,500

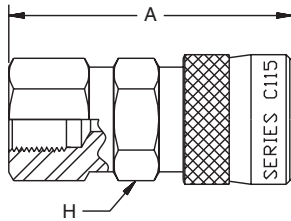

**C10-115-1202**

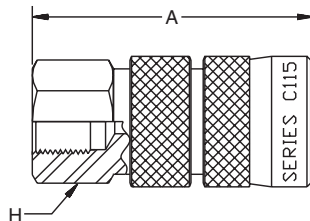

**C10-115-1222**

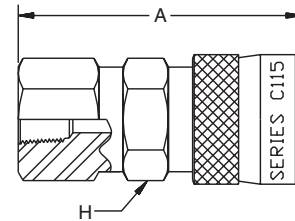

**C10-115-1401**

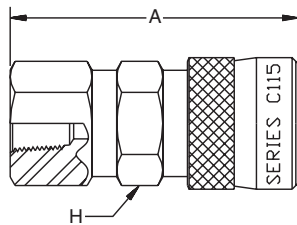

**C10-115-1402**

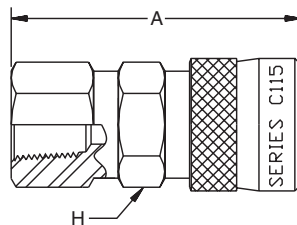

**C10-115-1404**

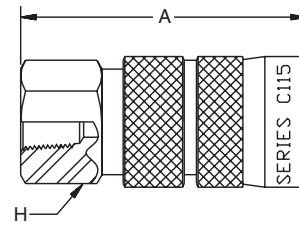

**C10-115-1422**

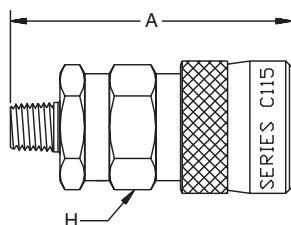

**C10-115-1452**

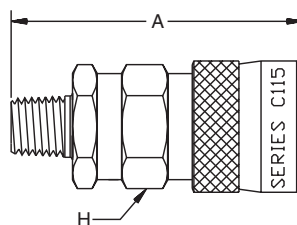

**C10-115-1454**

# 115 Nipple

Part Number	Connection Type	A Overall Length	H Hex Size	Maximum Working Pressure
#				
		inch	inch	psi
C10-115-6202	1/4" BSP Female	1.47	0.87	14,500
C10-115-6204	3/8" BSP Female	1.56	0.94	14,500
C10-115-6401	1/8" NPT Female	1.42	0.87	14,500
C10-115-6402	1/4" NPT Female	1.42	0.87	14,500
C10-115-6404	3/8" NPT Female	1.46	0.94	14,500
C10-115-6452	1/4" NPT Male	2.40	0.87	14,500
C10-115-6454	3/8" NPT Male	2.55	0.94	14,500

**D**

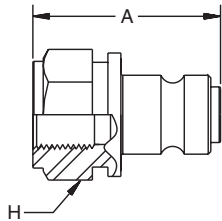

**C10-115-6202**

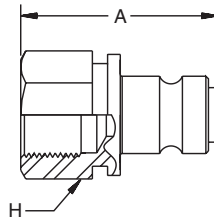

**C10-115-6204**

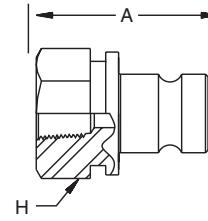

**C10-115-6401**

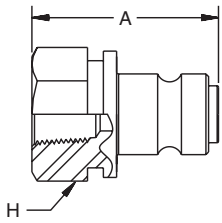

**C10-115-6402**

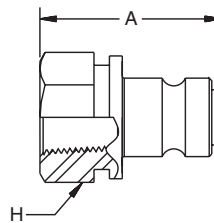

**C10-115-6404**

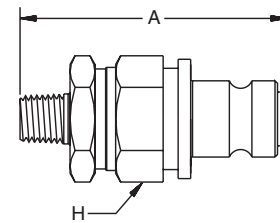

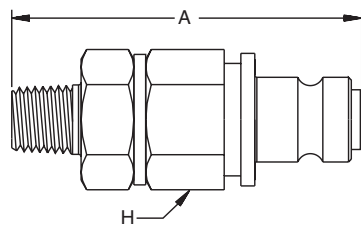

**C10-115-6452**



**C10-115-6454**

# 116

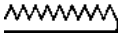
## Coupler

Part Number	Connection Type	A Overall Length	H Hex Size	Maximum Working Pressure
#				
		inch	inch	psi
C10-116-1202	1/4" BSP Female	2.30	0.94	21,800
C10-116-1222	1/4" BSP Female (with built-in locking device)	2.30	0.94	21,800
C10-116-1402	1/4" NPT Female	2.30	0.94	15,000
C10-116-1422	1/4" NPT Female (with built-in locking device)	2.30	0.94	15,000

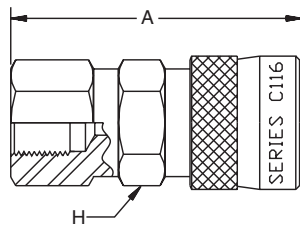

**C10-116-1202**

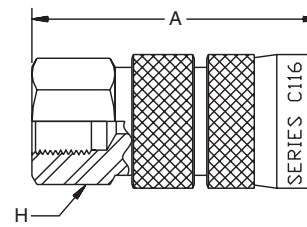

**C10-116-1222**

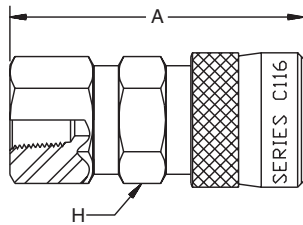

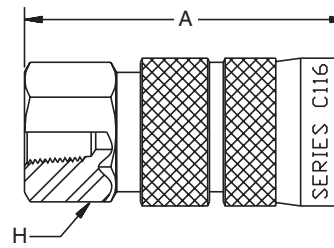

**C10-116-1402**



**C10-116-1422**

# 116 Nipple

Part Number	Connection Type	A Overall Length	H Hex Size	Maximum Working Pressure
#				
		inch	inch	psi
C10-116-5202	1/4" BSP Female (thru type)	1.47	0.87	21,800
C10-116-6202	1/4" BSP Female	1.47	0.87	21,800
C10-116-6402	1/4" NPT Female	1.41	0.87	15,000

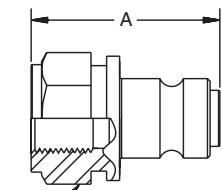

**C10-116-5202**

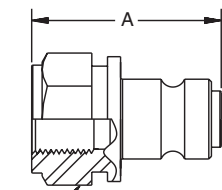

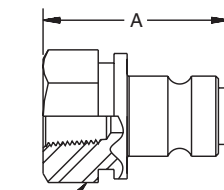

**C10-116-6202**



**C10-116-6402**

**D**

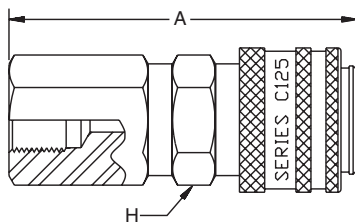

# 125 Coupler

Part Number	Connection Type	A Overall Length	H Hex Size	Maximum Working Pressure
#				
		inch	inch	psi
C10-125-1202	1/4" BSP Female	2.65	0.94	29,000



**C10-125-1202**

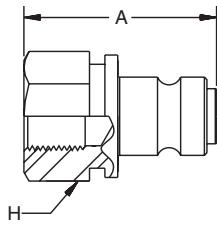

**125**  
**Nipple**

Part Number	Connection Type	A Overall Length	H Hex Size	Maximum Working Pressure
#				
		inch	inch	psi
C10-125-5202	1/4" BSP Female (thru type)	1.50	0.87	29,000
C10-125-6202	1/4" BSP Female	1.50	0.87	29,000



**C10-125-5202,  
C10-125-6202**

## Quick Coupling Adapters

Part Number	Connection Type	A Overall Length	H Hex Size	Maximum Working Pressure
#				
		inch	inch	psi
<b>C09-125-1680</b>	1/4" BSP 120° external cone x 1/4" HP Male	1.72	0.67	14,500
<b>C19-950-0029</b>	1/4" BSP 120° external cone x 9/16" UNF Hose	1.48	0.67	14,500
<b>C19-950-0062</b>	1/4" BSP Rubber Metal Seal	0.08	14,500	
<b>C19-950-0064</b>	3/8" BSP Rubber Metal Seal	0.08	0.94	14,500
<b>C19-950-1600</b>	1/4" BSP 120° external cone Blind Plug	1.07	0.67	14,500
<b>C19-950-1601</b>	1/4" BSP x 1/4" BSP with 120° external cones	1.76	0.08	14,500
<b>C19-950-1602</b>	1/4" BSP 120° external cone x 1/4" BSP 60° internal cone	1.54	0.83	14,500
<b>C19-950-1622</b>	1/4" BSP x 1/4" BSP with 60° internal cones	1.25	0.83	14,500
<b>C19-950-1623</b>	1/4" NPT Male x 1/4" BSP with 60° internal cone	1.27	0.83	14,500
<b>C19-950-1680</b>	Porting Block	1.80	2.00	14,500
<b>HAHM4BM4</b>	1/4" BSP with 60° internal cone x 1/4" HP Male	1.47	0.83	14,500

**D**

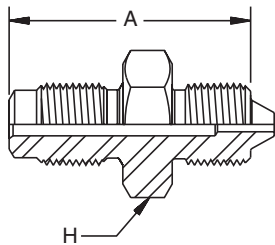

**C09-125-1680**

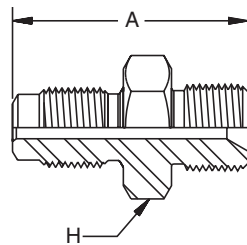

**C19-950-0029**

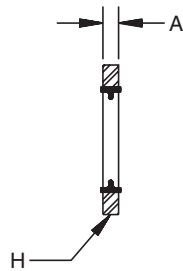

**C19-950-0062,  
 C19-950-0064**

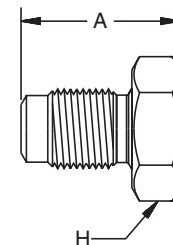

**C19-950-1600**

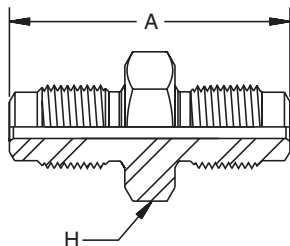

**C19-950-1601**

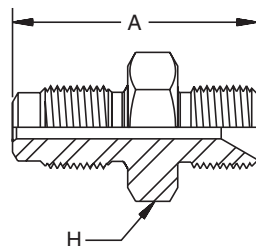

**C19-950-1602**

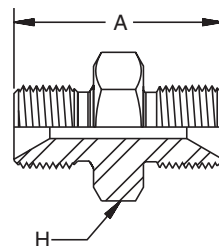

**C19-950-1622**

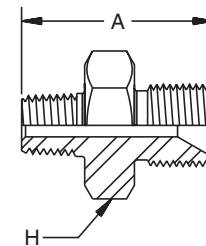

**C19-950-1623**

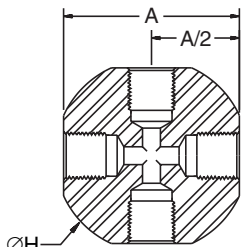

**C19-950-1680**

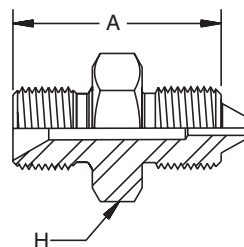

**HAHM4BM4**

## WB Series

### Applications

Parker's WB Series couplings are designed for equipment used in cleaning applications such as paint removal or mill scale. The 10,000 psi operating pressure of the WB series makes it ideal for applications that require a high pressure coupling with minimal pressure drop.



### Features

- Push-to-Connect allows for quick, easy connections by eliminating the need to retract the sleeve to couple.
- Locking collets in the female half maintain 360 degree contact with male half to evenly distribute load and reduce brinelling.
- Zinc plating with yellow chromate finish resists corrosion.
- Straight through design allows for excellent flow with low pressure drop.
- Two knurled bands on the sleeve provide good gripping for operation of sleeve to disconnect.
- Sleeve Lock design prevents accidental disconnects.
- Stainless steel collets resist corrosion and provide smooth latching action.
- Teflon<sup>®</sup> backup washer ensures sealing integrity at high pressure.
- Induction hardened locking groove on the male half reduces wear and brinelling.
- Sleeve guard prevents accidental disconnect and seals the opening between the sleeve and the body from the environment.





### Specifications

Body Size	1/2"
Temperature Range	-40°F to +250°F (-40°C to +121°C)
Maximum Operating Pressure	10,000 PSI (69 MPa)
Rated Flow	45 GPM (170 LPM)



# 125

## WB Coupler



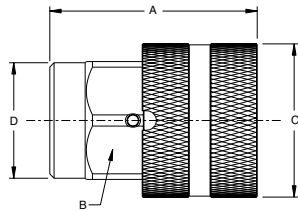

Part Number	Connection Type	A Overall Length	B Hex Size	C Largest Diameter	D Turned Diameter	Maximum Working Pressure
#						
		inch	inch	inch	inch	psi
WB-501-8FP	1/2-14 NPTF	2.10	1.25	1.25	1.25	10,000



### WB-501-8FP

# 125

## WB Nipple

Part Number	Connection Type	E Overall Length	F Exposed Length	G Hex Size	H Largest Diameter	Maximum Working Pressure
#						
		inch	inch	inch	inch	psi
WB-502-8FP	1/2-14 NPTF	2.35	1.26	1.13	1.63	10,000

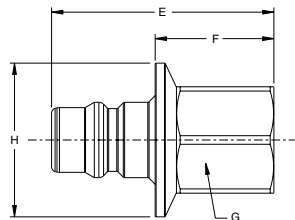

### WB-502-8FP



## Table of Contents

Heavy Duty Abrasion Cover .....	E2
Heavy Duty Abrasion Cover Sleeves .....	E2
Spring Guards .....	E2
Containment Grips .....	E2
Support Grips .....	E3
Bend Restrictors .....	E3
Anti-Gall Lubricant .....	E3
Pressure Containment Shield .....	E3
Dies, HP Fittings .....	E4
Dies, HP Guards .....	E4
Gauges, HP Fittings .....	E4
Dies, <b>polyflex</b> BOP Hose Fittings .....	E4
Karrykrimp .....	E5
Parkrimp I and II .....	E5
Superkrimp .....	E5

**E**

## Heavy Duty Abrasion Cover



Part No.	Description
#	
MHDC010	5/8" I.D. Clear Vinyl
MHDC011	5/8" I.D. Clear Vinyl with white Helix reinforcement
MHDC012	3/4" I.D. Clear Vinyl with white Helix reinforcement
MHDC014	7/8" I.D. Clear Vinyl with white Helix reinforcement
MHDC016	1" I.D. Clear Vinyl with white Helix reinforcement
MHDC018	1-1/8" I.D. Clear Vinyl with white Helix reinforcement
MHDC020	1-1/4" I.D. Clear Vinyl with white Helix reinforcement
MHDC022	1-3/8" I.D. Clear Vinyl with white Helix reinforcement
MHDC024	1-1/2" I.D. Clear Vinyl with white Helix reinforcement
MHDC026	1-5/8" I.D. Clear Vinyl with white Helix reinforcement
MHDC032	2" I.D. Clear Vinyl with white Helix reinforcement

## Spring Guards



Part No.	Description
#	
MSG060	0.60" I.D. Continuous Spring
MSG1006	For 2040N-04V00 Hose
MSG2006	For 2245N-04V00 Hose
MSG2106	For 2380N-04v00 Hose
MSG4113	For -8 Hoses
MSG4120	For 2440n-12V37 Hose
MSG4125	For 2440N-16V37 Hose
MSG6020	For 2640N-12v32 Hose

## Heavy Duty Abrasion Cover Sleeves



Part No.	Abrasion Cover Used On...
#	
508-J-500-10	MHDC010, MHDC011
510-A-500-12	MHDC012
612-400-14	MHDC014
216-200-18	MHDC016, MHDC018
620-100-18	MHDC018 (w/2640N-08 hose)
220-200-22	MHDC022, MHDC024
520-A-500-26	MHDC026

## Containment Grips



Part No.	Description
#	
MCG001SS	For Hose O.D. 0.38" - 0.69"
MCG002SS	For Hose O.D. 1.0" - 1.56"
MCG003SS	For Hose O.D. 1.25" - 1.94"
MCG005SS	For Hose O.D. 0.75" - 1.25"
MCGHS10-15	For Hose O.D. 0.40" - 0.59"
MCGHS15-20	For Hose O.D. 0.59" - 0.79"
MCGHS20-30	For Hose O.D. 0.79" - 1.18"
MCGHS30-40	For Hose O.D. 1.18" - 1.57"
MCGHS40-50	For Hose O.D. 1.57" - 1.96"
MCGHS50-60	For Hose O.D. 1.96" - 2.36"

## Black Eagle® Support Grip

Part No.	Description
#	
MCG014-02-1523	For Hose O.D. 2.25" - 2.94"
MSG014-02-1524	For Hose O.D. 2.75" - 3.44"

## Support Grips

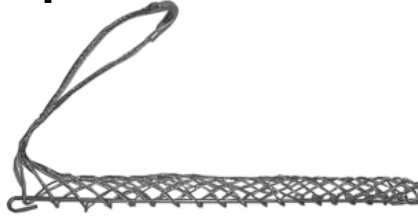

Part No.	Description
#	
MK022-03-038	For Hose O.D. 0.63" - 0.74"
MK022-03-039	For Hose O.D. 0.75" - 0.99"
MK022-03-041	For Hose O.D. 1.00" - 1.24"
MK022-03-042	For Hose O.D. 1.25" - 1.49"
MK022-03-043	For Hose O.D. 1.50" - 1.74"
MK022-03-045	For Hose O.D. 2.25" - 2.49"

## Bend Restrictors



Part No.	Description
#	
MBR003	Molded Vinyl 0.25" I.D.
MBR007	Molded Vinyl 0.41" I.D.
MBR008	Molded Vinyl 0.50" I.D.
MBR009	Molded Vinyl 0.562" I.D.
MBR010	Molded Vinyl 0.625" I.D.
MBR012	Molded Vinyl 0.77" I.D.
MBR013-B	Molded plastic for 2840D-03V32 hose
MBR2104	Molded Vinyl for 2244N-025V00 hose

E

## ThreadMate™ Anti-Gall Lubricant



Part No.	Description
#	
MTM04T	4-oz Tube

- ThreadMate is an extreme duty lubricant developed to reduce galling during the assembly of threaded parts.
- ThreadMate promotes reliable sealing of pipe threads even at high pressure by reducing friction and galling during tightening, resulting in higher contact pressures of the sealing surfaces, and better metal-to-metal contact.
- ThreadMate reduces the torque needed to make pressure tight connections and tighten fasteners.

## Pressure Containment Shield



Part No.	Description
#	
* MHBS012	3/4" I.D. Rubber Pressure Containment Shield
612-400-14	Pressure Containment Shield Sleeve
M55STIF2	Pressure Containment Shield Stiffener

\* Designated for the 2740D-03V30 and the 2840D-03V34 Hoses.

** MHBS016	1" I.D. Rubber Pressure Containment Shield
416-400-16	Pressure Containment Shield Sleeve

\*\* Designated for the 2740D-05V32 and the 2840D-05V32 Hoses.

## Dies, HP Fittings

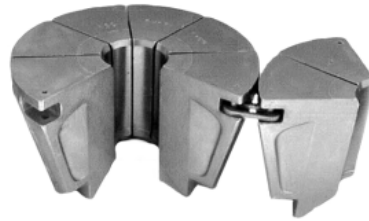

Part No.	Description
#	
80C-HP3	Dies for HP3 Fittings
80C-HP4	Dies for HP4 Fittings
80C-HP6	Dies for HP6 Fittings

## Dies, HP Guards

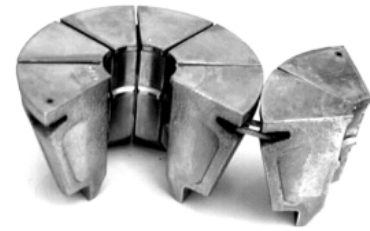

Part No.	Description
#	
80C-G03	Dies for HP3 Guards
80C-G04	Dies for HP4 Guards
80C-G06	Dies for HP6 Guards

## Gauges, HP Fittings



Part No.	Description
#	
HP-3-Gauge	Gauge for HP-3 Fittings
HP-4-Gauge	Gauge for HP-4 Fittings
HP-6-Gauge	Gauge for HP-6 Fittings

## Dies, **polyflex** BOP 2390N, Seawolf 57CR Hose Fittings



Part No.	Description
#	Hose Types
83C-9X04	2390-04
83C-9X08	2390-08
83C-9X16	2390-16
80C-F08W	57CR-8
83C-F16W	57CR-16

## Parkrimp I

Parkrimp I offers hose assembly capability through 1-1/4", SAE 100R1, 100R2, 100R7, 100R8, 100R9 and 100R14. Its patented design provides you with the ability to crimp straight – as well as bent tube hose ends; a full power return cycle allows quick, easy size and hose type changes, while the die pusher automatically moves out of the way for easy die insertion: Bench mounted at a 20° angle lets you load and unload hydraulic assemblies as easily as possible. Parkrimp I gives you the ease and flexibility to manufacture hydraulic hose assemblies you require – and in less than ten seconds.



- Part No.**  
**80C-001-PFD** ..... Machine with power unit, silver die ring and dies 80C-P04, P06, P08, P12  
**80C-081-PFD** ..... Machine with power unit and without silver die ring and dies  
**80C-R01-PFD** ..... Silver die ring

## Parkrimp II

Parkrimp II provides you with total capability to manufacture hydraulic hose assemblies up through 2". Parkrimp II's advanced design – with capacity to handle 100R1 through 100R14 hose types, coupled with straight or bent tube ends – is the industry's leading edge in the manufacture of hydraulic hose assemblies. Unparalleled in its design, Parkrimp II needs no special adjustments or gauge settings. Simply insert the unitized or split die train for the appropriate size – and with push button ease you have factory-quality assemblies in just seconds.



**Part No. 83C-081-PFD**

**E**

## MiniKrimp™



### Standard Equipment

Model 94C-001-PFD includes:

Part Number	Part Description
94C-080-PFD	MiniKrimp™ Portable Crimping Machine
015301	Hand Pump
82C-R01-PFD	Die Ring – Color Coded Silver

### Optional Equipment

Part Number	Part Description
015736	Side Vise Mount
015306	Upright Table Mount
015307	Upright Vise Mount
82C-R02-PFD	Die Ring – Color Coded Black
015309	Hose Assembly
015308	Replacement Tube Assembly w/o Fittings





## Table of Contents

<b>polyflex</b> Hose — Determination of Length of Hose for Over-the-Sheave Applications.....	F2
Installation Tips .....	F3
Recommended Practice for Selection, Installation, and Maintenance of <b>polyflex</b> Hose Assemblies .....	F4
Dash Size Systems for Hose and Tubing .....	F5
Selection of Hose Diameter .....	F6
Twin/Multi-Line Separation Instructions.....	F8
Volumetric Expansion Data .....	F9
Pressure Drop vs. Flow .....	F10
Government & Agency Approvals .....	F15
Glossary .....	F16
Gas Permeability of Plastics.....	F17
Recommended Tightening Procedures.....	F18
Metric Conversions .....	F19
Chemical Resistance .....	F20
Parker Safety Guide .....	F25

**F**

## Installation Tips

### **polyflex** Hose —

### Determination of Length of Hose for Over-the-Sheave Applications

The exact cutoff length for an optimum over-the-sheave assembly depends on the particular mechanical arrangement of the machine. A method for finding an approximate starting point is as follows:

1. Assemble hose with one coupling as shown in diagram.
2. Measure hose length from point 1 to point 2 **with hose taut**. ( $L_o$  = length)
3. Calculate hose cutoff or free length  $L_F$ :  
 $L_F = 0.985 L_o + 2x$   
Where  $L_F$  includes coupling insert allowance on both ends. The coupling insert allowance ( $x$ ) may be found from the coupling dimension tabulations in the fittings sections section of this fitting section or from direct measurement on the coupling. A 1.5% stretch allowance is provided in this formula.
4. Couple the remaining hose end and assemble on the machine.

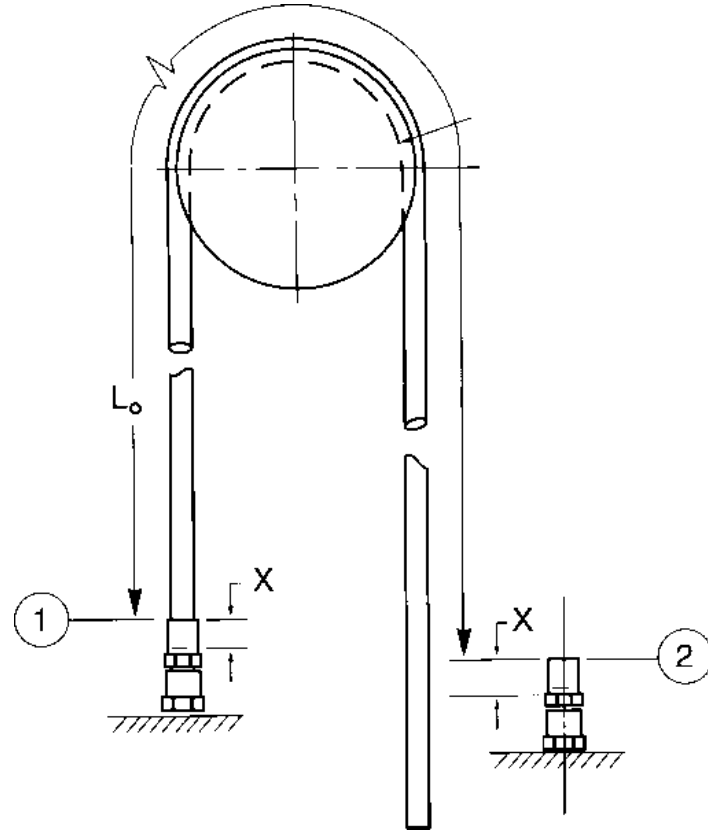

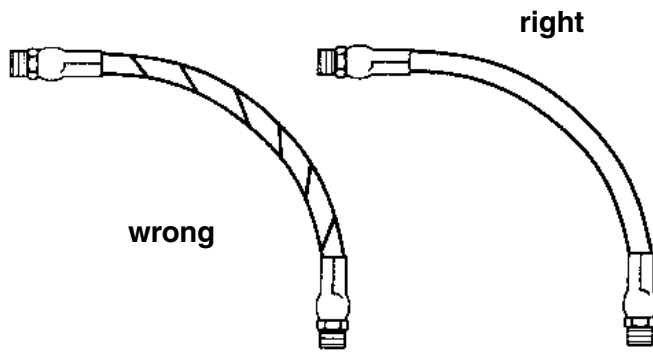

Hose is weakened when installed in twisted position. Also, pressure pulses in twisted hose tends to fatigue wire and loosen fitting connections. Design so that machine motion produces bending rather than torsion.

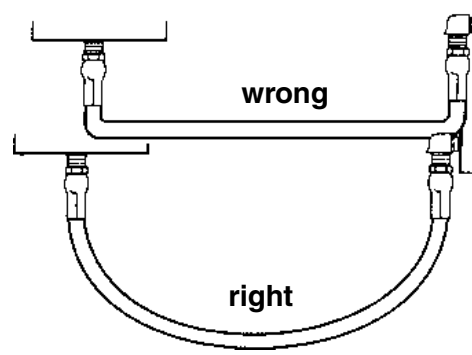

Hose should exit coupling in a straight position rather than side loaded. Ample bend radius should be provided to avoid collapsing of hose and flow restriction. Exceeding minimum bend radius will greatly reduce hose assembly life.

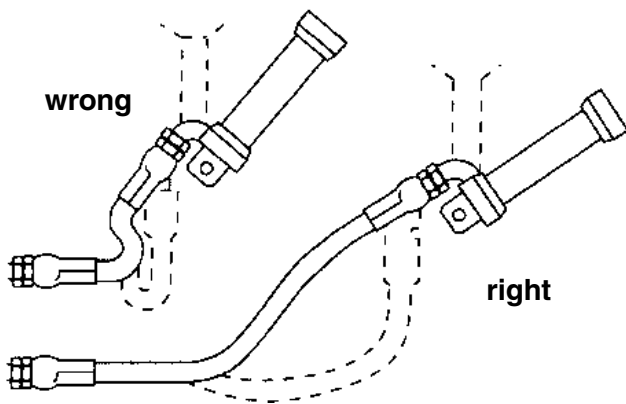

When hose assembly is installed in a flexing application, remember that metal hose fittings are not part of the flexible portion. Allow ample free length for flexing.

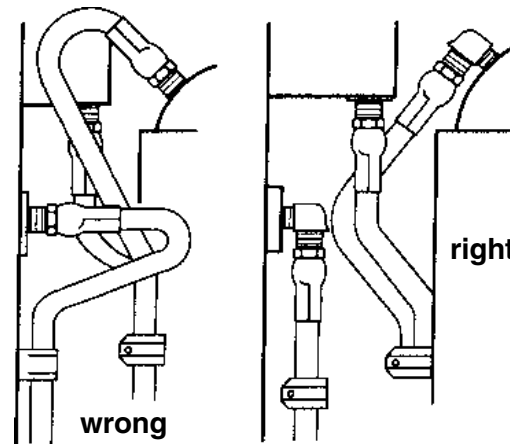

Use elbows or other adapters as necessary to eliminate excess hose length and to ensure neater installation for easier maintenance.

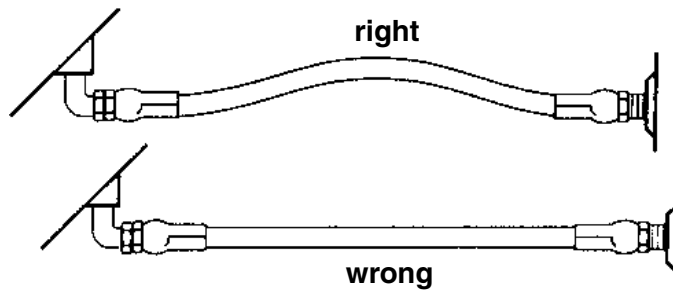

Pressure can change hose length as much as  $\pm 3\%$ . Provide slack in line to compensate for hose length changes.

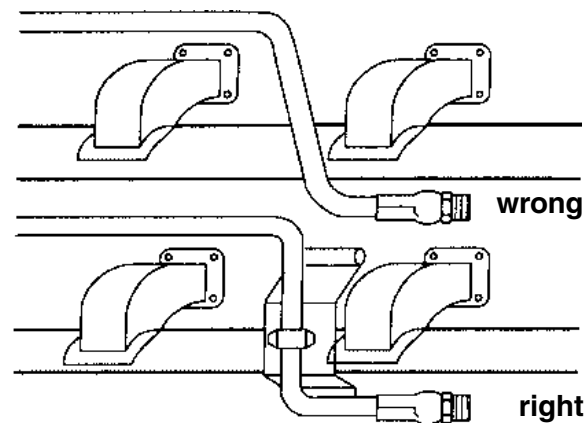

Avoid installing hose line close to exhaust manifold or any other hot section. If possible, isolate hose with fireproof boot or other protective means.

**F**

## Recommended Practice for Selection, Installation, and Maintenance of **polyflex** Hose and Hose Assemblies

Hose and hose assemblies have a finite life span and many things reduce this time. This recommended practice should be read by designers and users of hose to assist them in the proper selection of hose. These guidelines, while not all inclusive, will assist the user in maintaining hydraulic and pneumatic systems.

**READ THE PARKER SAFETY GUIDE CONTAINED IN THIS CATALOG IN ITS ENTIRETY.**

### PART ONE –How to Select Hose

- **Pressure** –Maximum operating pressure of the hose must be greater than or equal to the system pressure. Pressure surges or system “spikes” in excess of the maximum operating pressure will shorten hose life and must be avoided.
- **Temperature** –Ambient and fluid temperatures must not exceed the hose/fittings rated design temperature. Attempt to route hose or shield hose from high temperature sources.
- **Size** –Adequately size hose and fittings to avoid damaging hose with excessive turbulence, or heat build-up, while maintaining proper flow and pressure. (Refer to fluid velocity nomogram.)
- **Fluid compatibility** –Refer to Chemical Compatibility Guide in this catalog for use of fluids with various materials. If unsure of an application, contact the factory. Additional care must be taken with gaseous applications. (See Safety Guide at end of catalog.)
- **Environment** –Conditions such as ozone, UV light, harsh chemicals, salt water, and other airborne contaminants can degrade hose and shorten its life.
- **Length** –Hose length changes with pressure. This, along with equipment movement, must be considered in the system design.
- **Proper couplings** –Always follow manufacturers specifications and do not mix components of different manufacturers.
- **Mechanical loads** –Conditions such as tensile and side loads, vibration, excessive flexing, and twist will reduce hose life. Use swivel fittings and adapters to avoid hose twisting. Test the hose if the application is potentially problematic or unusual.
- **Electrical conductivity** –Determine if the hose must be non-conductive to prevent electrical current flow or conductive to dissipate static electricity. Choose hose and fittings accordingly. (See Safety Guide for Electrical Conductivity issues.)

### PART TWO –Installation and Maintenance

- **Inspect components** –Check hose for cover cracks, blisters, cleanliness, kinks, cracks or core tube obstructions or other defects. Examine fittings for poor threads, obstructions, cracks, rust. Do not use hose or fittings if these problems exist.
- **Assemble per instructions contained in this catalog.**
- **Do not exceed specified minimum bend radius** –Use stress relievers to prevent sharp bends at the hose and fitting juncture. These can be spring guards or other stress relieving members.
- **Ensure that hose bends rather than twists with equipment motion.**
- **Use a torque wrench or the flats from finger tight method to properly install port connections.**
- **After installation, eliminate air entrapped in system, pressurize to maximum operating pressure, and check for leaks and proper system function.**
- **After installation, periodically (frequency depends on severity of application and potential risk) inspect the system for the following:**
  1. Blistered, degraded, or loose hose covers.
  2. Stiff, cracked, or charred hose.
  3. Cuts or abrasion of hose. Look for exposed reinforcement.
  4. Leaks in hose or fittings.
  5. Damaged or corroded fittings.
  6. Excessive build up of dirt, grease, oils, etc.
  7. Defective or broken clamping devices, shields.
  8. Kinks in hoses.

Upon discovery of any of these items, replace it, repair it, but **DO NOT IGNORE IT!**
- Retest the system after all maintenance procedures.
- Establish replacement schedules based on previous service life, or when failures could result in damage, personal injury, excessive or unacceptable downtime.

## Dash Sizes

Dash sizes are commonly used to designate hose I. D., plastic tubing and metal tubing O. D. and coupling size. Dash size systems in common use:

Nominal Hose I. D. or Tubing O. D.		Dash Number for all <b>polyflex</b> Hose	Dash Number for TFE Hose	Nominal DIN Size
Inches	Millimeters			
1/8	3.2	-2	-	-
3/16	4.8	-3	-4	5
1/4	6.3	-4	-5	6
5/16	7.9	-5	-6	8
3/8	9.5	-6	-	10
13/32	10.3	-6.5	-8	-
1/2	12.7	-8	-10	12
5/8	15.9	-10	-12	16
3/4	19.1	-12	-	20
7/8	22.2	-14	-16	-
1	25.4	-16	-	25
1-1/8	28.6	-	-20	-
1-1/4	31.8	-20	-	32
1-3/8	34.9	-	-24	-
1-1/2	38.1	-24	-	40
1-13/16	46.0	-	-32	-
2	50.8	-32	-	50



## Selection of Hose Diameter from Flow Rate and Velocity

The Fluid Velocity Nomogram gives the velocity of a liquid or gas as a function of flow rate and inside diameter of the fluid line. The commonly recommended maximum velocities for hydraulic oil systems at 200°F or less are indicated for guidance.

**Example:** At 10 gpm, what is the minimum size within the recommended velocity range for a hydraulic pressure line?

The dashed line drawn from the 10 gpm mark on the left hand line to the maximum velocity of 20 fps intersects the middle line at .438" (7/16" I. D. hose or tubing).

For a hose application, use 1/2" I. D., the nearest common standard size.

This chart is based on the following formulas:  $V_{fps} = \frac{.321Q}{\frac{pd^2}{4}}$  , Q = gal per min  
 d = hose or tube I. D. (inch)

$$\text{cu. ft./min.} = .1337 Q$$

The cu. ft. per min. value is the actual volume flow rate under flowing conditions.  
 For air, standard cfm of free air = 7.81 actual cfm when the inlet air is at 100 psig, 68°F.

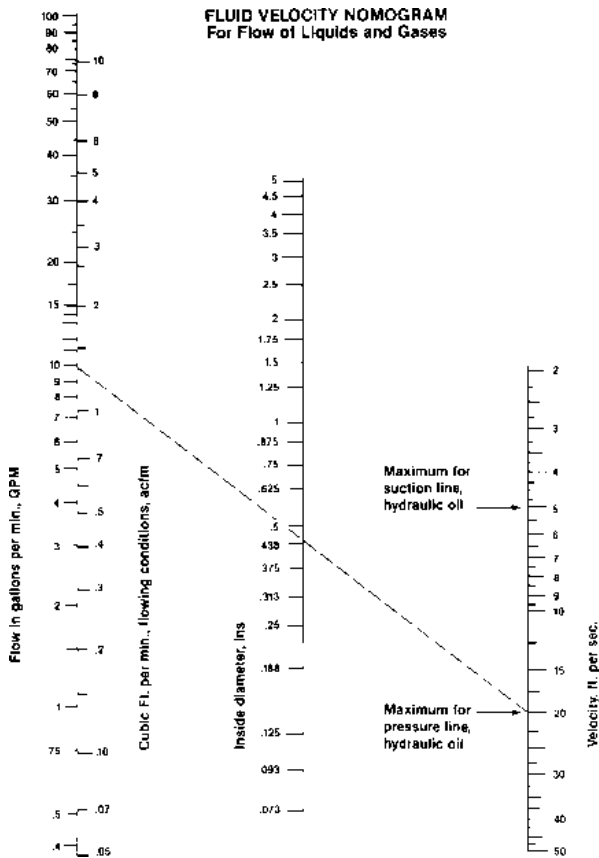

**Determination of Pressure Drop in the Line**

$$\text{Velocity: } v = .409 \frac{Q}{d^2} = .0509 \frac{W}{pd^2} = \frac{q}{.785d^2}$$

$$\text{Reynold's Number: } Re = 124 \frac{dvp}{\mu} = 6.31 \frac{W}{d\mu} = 378 \frac{qp}{d\mu}$$

Pressure Drop, Isothermal, Incompressible Flow (Liquids):

$$P = .001294 \frac{fLpv^2}{d} = .00000336 \frac{fLW^2}{pd^5} = .0121 \frac{fLq^2}{d^5}$$

Pressure Drop, Isothermal, Compressible, Long Lines (Gases and Vapors):

$$\frac{P}{P_1} = 1 - \frac{1 - \frac{fLp_1v_1^2}{12gdP_1}}{1}$$

**Symbols and Units for Listed Formulas**

**d** = inside diameter of hose, inches

**f** = friction coefficient, dimensionless

**g** = gravitational constant, 32.2 ft./sec.<sup>2</sup>

**P1** = input pressure, psi

**P** = pressure difference, psi

**q** = rate of flow at flowing condition, cu. ft./min.

**Q** = rate of flow, gals./min.

**Re** = Reynolds number, dimensionless

**v** = flow velocity, ft./sec.

**W** = rate of flow, lbs./hr.

**p** = weight density of fluid, lbs./cu. ft.

**μ** = absolute (dynamic) viscosity, centipoises

**F**

## Twin Line and Multi-Line Separation Instructions

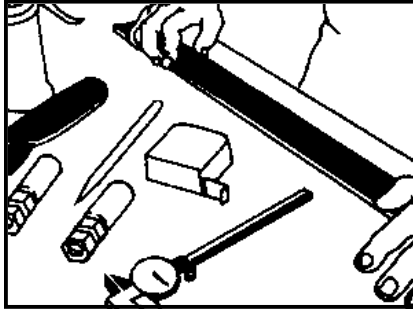

1. Position twinned or multi-line hose assembly so that it lies flat on work surface without tendency to twist or turn.

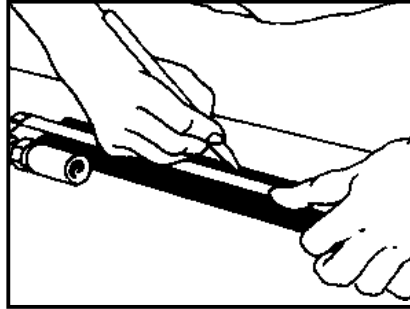

2. Measure and mark the length that the hoses are to be separated. **Note:** if length of separation is specified from the threaded or swivel nut end of coupling, deduct the cutoff allowance dimension for the specific style of coupling used. The cutoff allowance is obtainable from the hose fitting tables found in the hose fitting tables or can be calculated by subtracting the insertion depth of the shell from the overall coupling length.

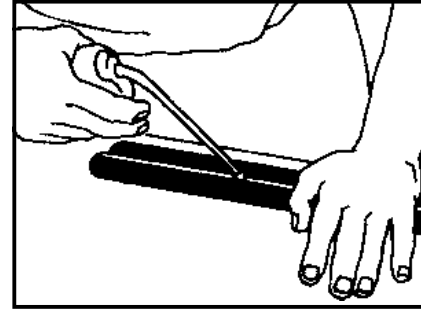

3. Lightly lubricate the web area between the hoses. Distribute the lubricant uniformly along the web of the assembly to be separated. Parker Hoze-Oil or any lightweight oil will suffice. (SAE 10 or 20) The function of the oil is to reduce the friction of the knife blade so that it naturally seeks the center of the valley formed by the hoses. This eliminates the need for the operator to steer the knife.

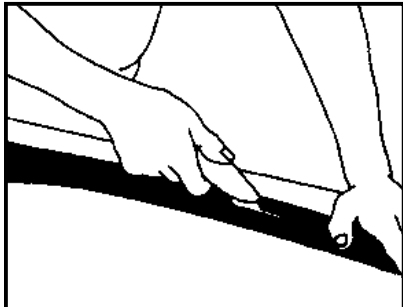

4. Press the multi-line hose assembly firmly and flat against the work surface with your free hand so that it does not move. Using a Stanley trimming knife model No. 10-515 or equivalent, draw the knife toward you with constant light to moderate pressure, and a smooth stroke. Three or four strokes will be necessary to separate the hoses.

**NOTE:**

- It is important that the knife blade be perpendicular to the hose during this procedure so that the blade cuts only the center line of the web. **EXTREME CARE MUST BE TAKEN TO AVOID CUTTING THROUGH THE COVER OF THE HOSES AND THEREBY EXPOSING THE FIBER REINFORCEMENT.** If this occurs, the hose assembly must be discarded. (see photo A.)

If the separation length is greater than that which can be accomplished with one continuous, smooth stroke, then the procedure should be repeated over shorter distances always cutting toward the free end of the hoses.

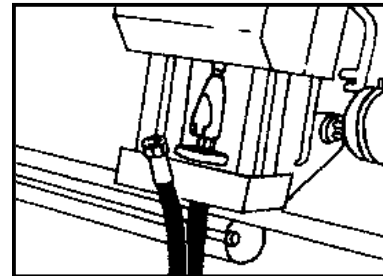

5. It is suggested that the separation length be sufficiently long so that the swaging or crimping operation can be accomplished without risk of kinking the hoses or tearing the web which could result in exposure of the braided reinforcement. (see photo B)

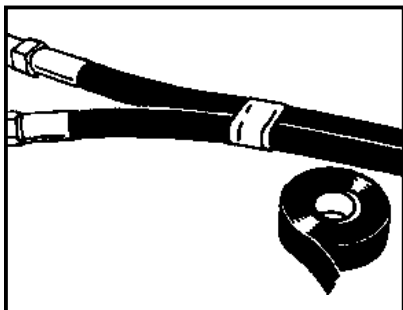

6. At the option of the assembler as dictated by the installation, it is suggested that a nylon lashing strap or tape be applied at the termination of the separated length to provide protection against tearing of the web or hose covers.

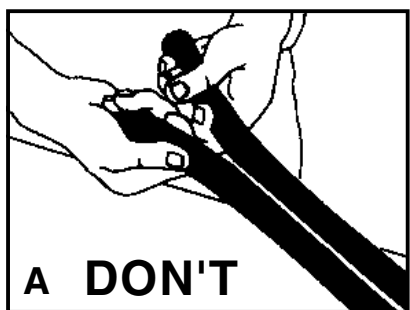

**EXTREME CARE MUST BE TAKEN TO AVOID CUTTING THROUGH THE COVER OF THE HOSES AND THEREBY EXPOSING THE REINFORCEMENT.** If this occurs, the hose assembly must be discarded.

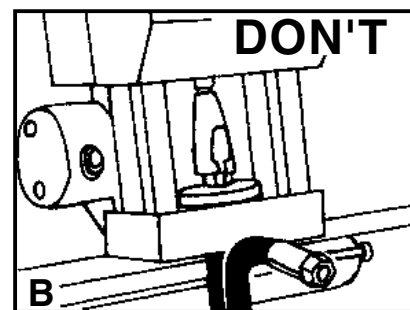

The separation length must allow for the swaging or crimping operation without damaging the hose.



## Volumetric Expansion Data For HP/HP8 Thermoplastic Hose

(▲ indicates hose working pressure)

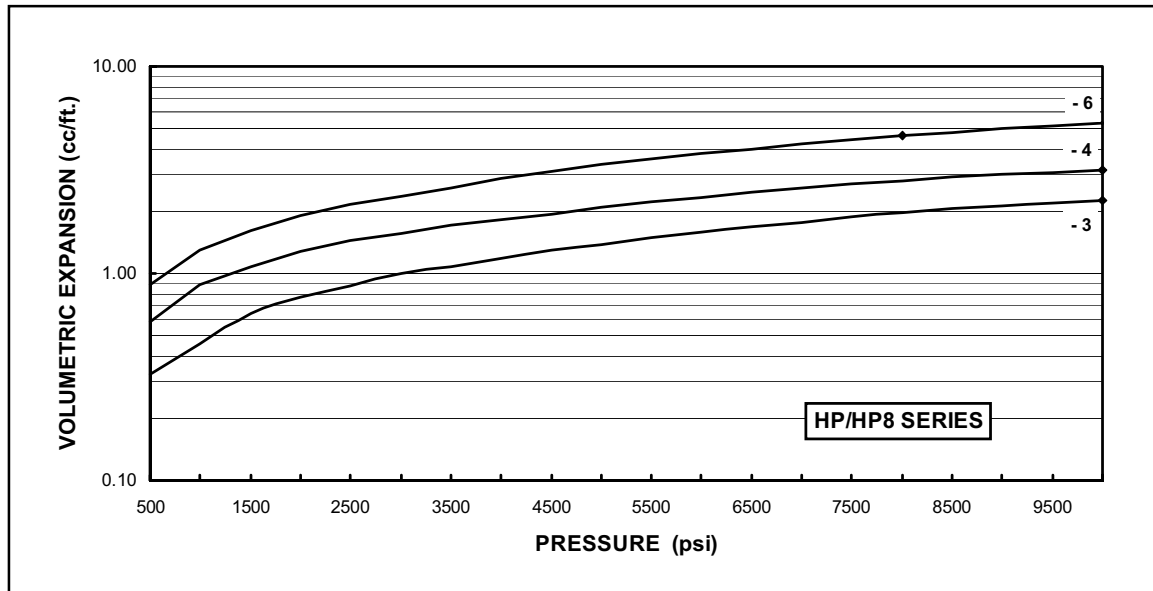

**F**

**For Hose Types:**  
**2040N-2V00 (1003 K)**  
**2020N-2V30 (1003 MK)**

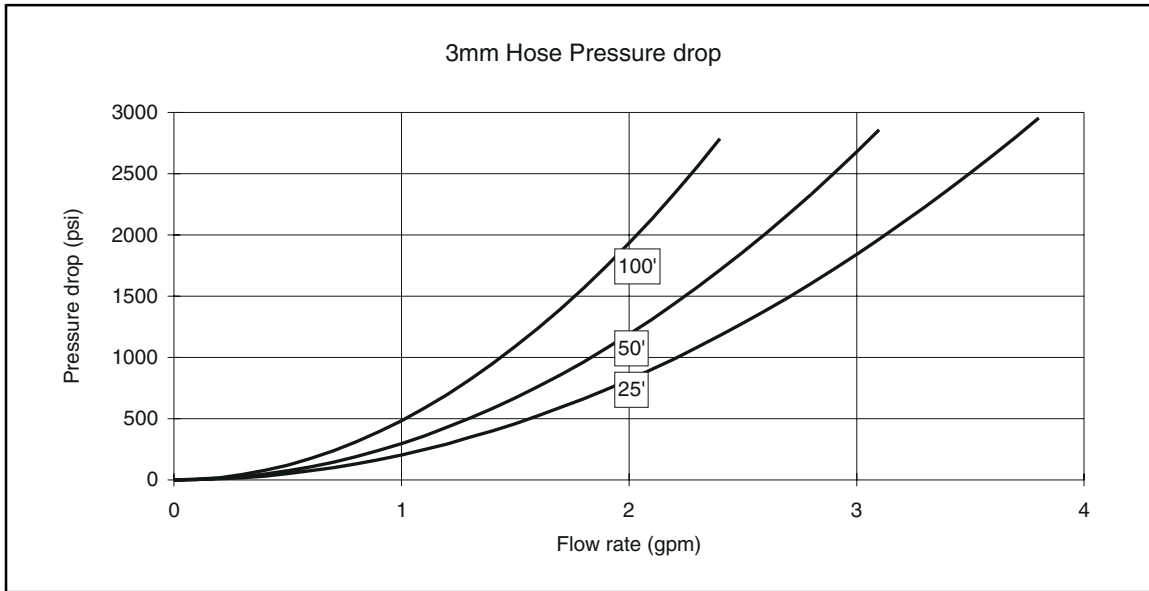

**For Hose Types:**  
**2240D-025V34 (2004 STR)**      **2244N-025V00 (2104 ST)**  
**2243D-025V70 (2004 STV)**      **2640D-025V32 (6004 ST)**

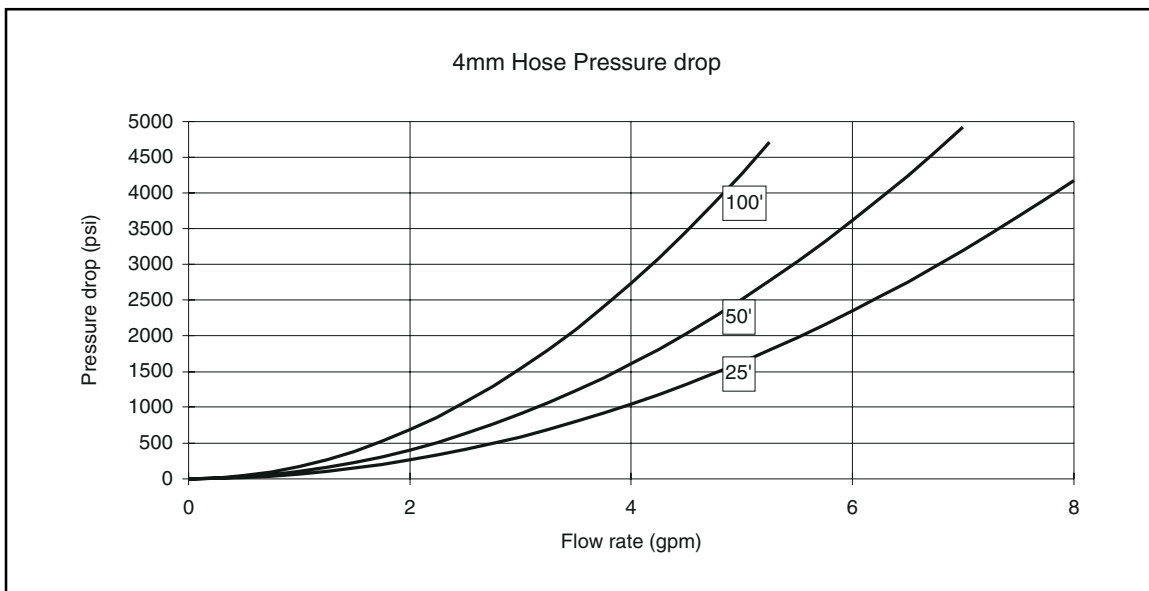

Results obtained from actual pressure drop tests, pumping water through hose assemblies with normal end fittings.

**For Hose Types:**

- |                               |                              |
|-------------------------------|------------------------------|
| <b>2245D-03V32</b> (2005 STR) | <b>2640D-03V32</b> (6005 ST) |
| <b>2243D-03V70</b> (2005 STV) | <b>2740D-03V30</b> (6105 ST) |
| <b>2440D-03V37</b> (4005ST)   |                              |

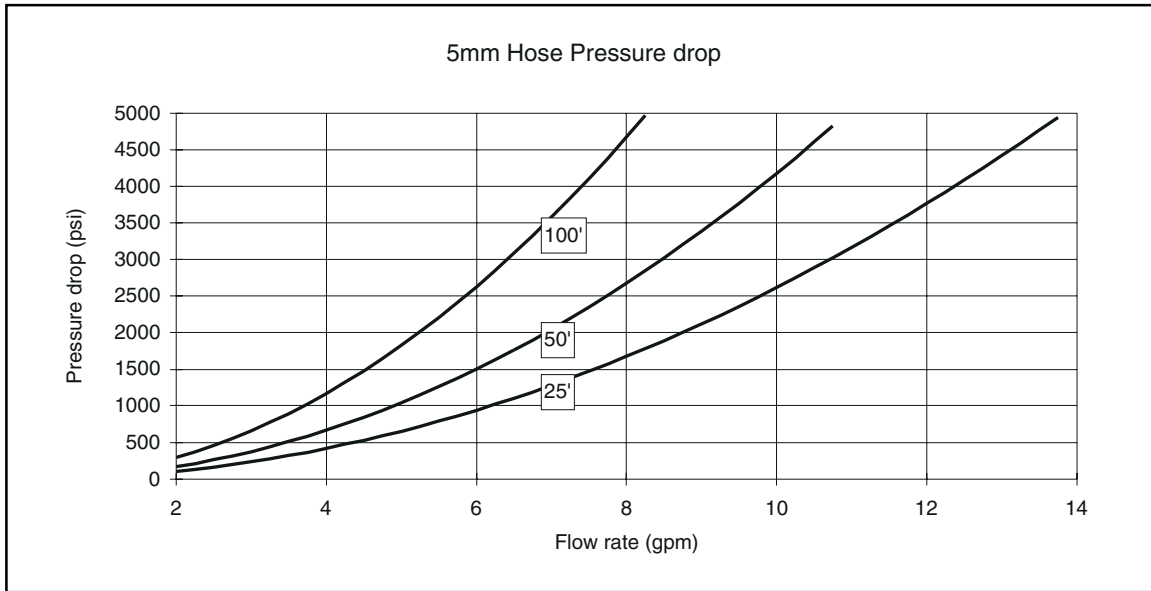

**For Hose:**  
**2840D-03V34** (8005 ST)

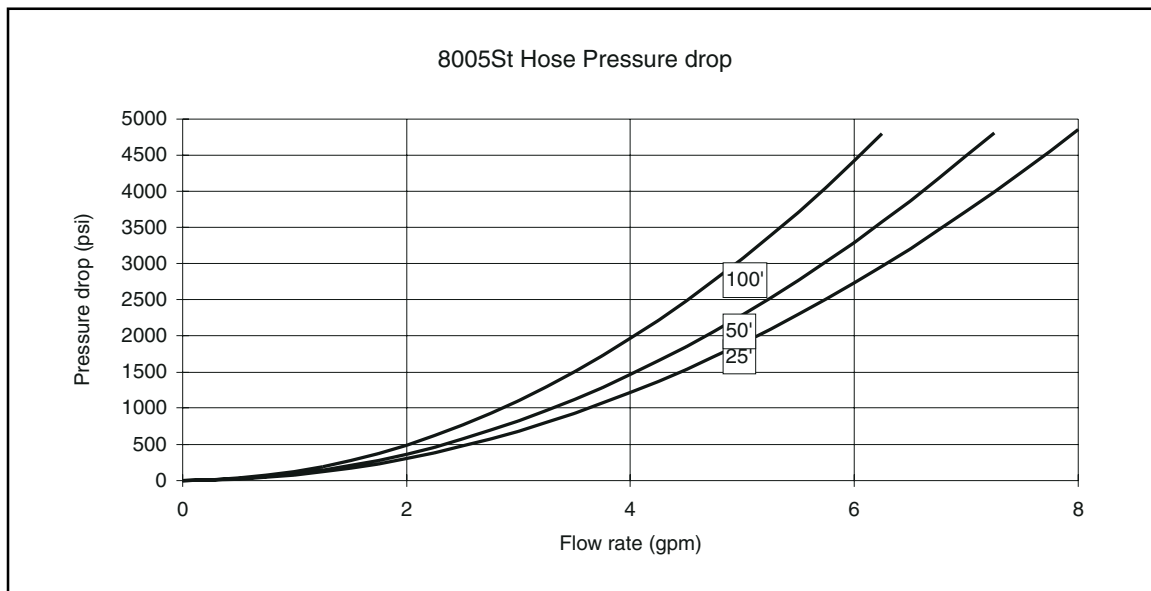

Results obtained from actual pressure drop tests, pumping water through hose assemblies with normal end fittings.

**For Hose Types:**

- |                               |                              |
|-------------------------------|------------------------------|
| <b>2245N-04V00</b> (2006 ST)  | <b>2380N-04V00</b> (2106 ST) |
| <b>2380N-04V33</b> (2006 STA) | <b>2390N-04V00</b> (2206 ST) |
| <b>2240NW-04V10</b> (2006SS)  | <b>2440N-04V37</b> (4006ST)  |

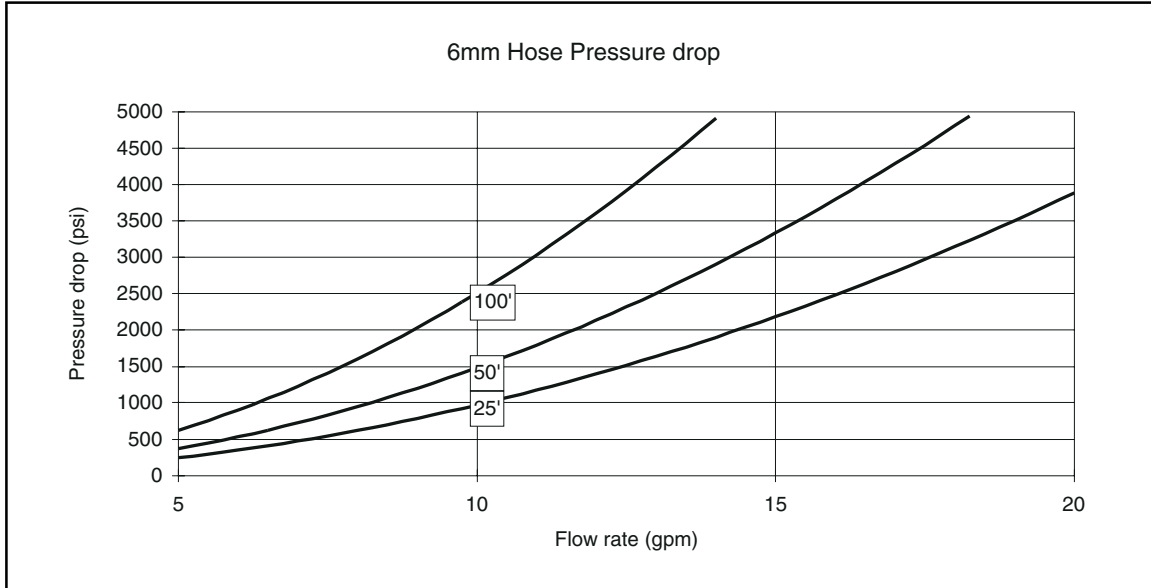

**For Hose Types:**

- |                               |                              |
|-------------------------------|------------------------------|
| <b>2240NW-05V10</b> (2008 SS) | <b>2440D-05V37</b> (4008 ST) |
| <b>2380N-05V00</b> (2108 ST)  | <b>2740D-05V32</b> (6108 ST) |

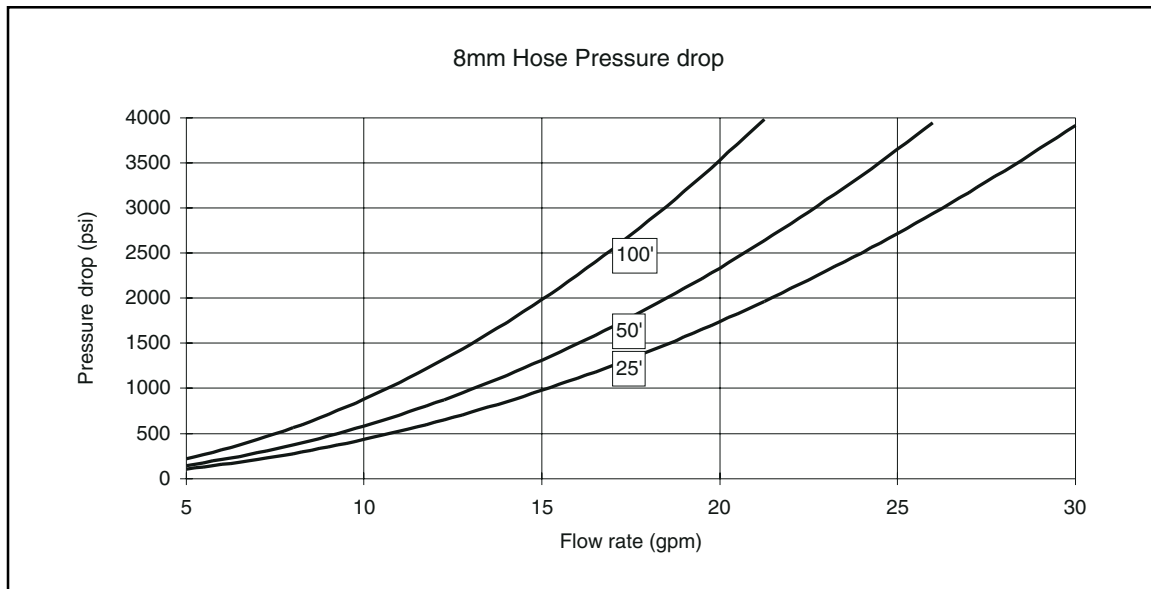

Results obtained from actual pressure drop tests, pumping water through hose assemblies with normal end fittings.

**For Hose:  
 2390N-06V13 (2210 ST)**

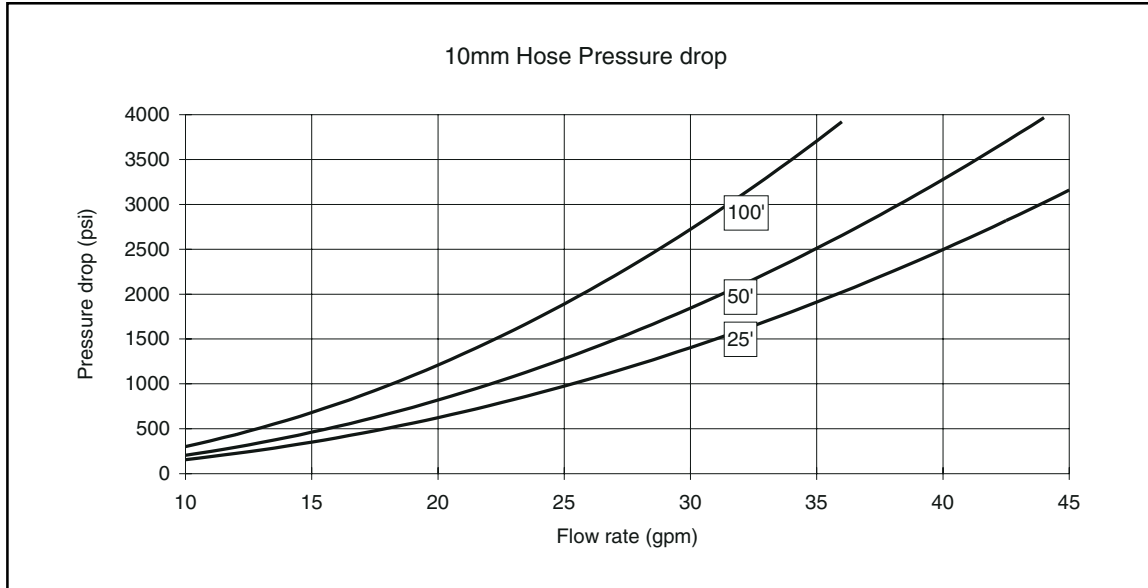

**For Hose Types:**

- |                               |                               |
|-------------------------------|-------------------------------|
| <b>2245N-08V30 (2013 ST)</b>  | <b>2240NW-08V30 (2113 SS)</b> |
| <b>2245N-08V30 (2113 ST)</b>  | <b>2440N-08V37 (4113 ST)</b>  |
| <b>2390N-08V13 ( 2213 ST)</b> | <b>2640N-08V32 (6013 st)</b>  |

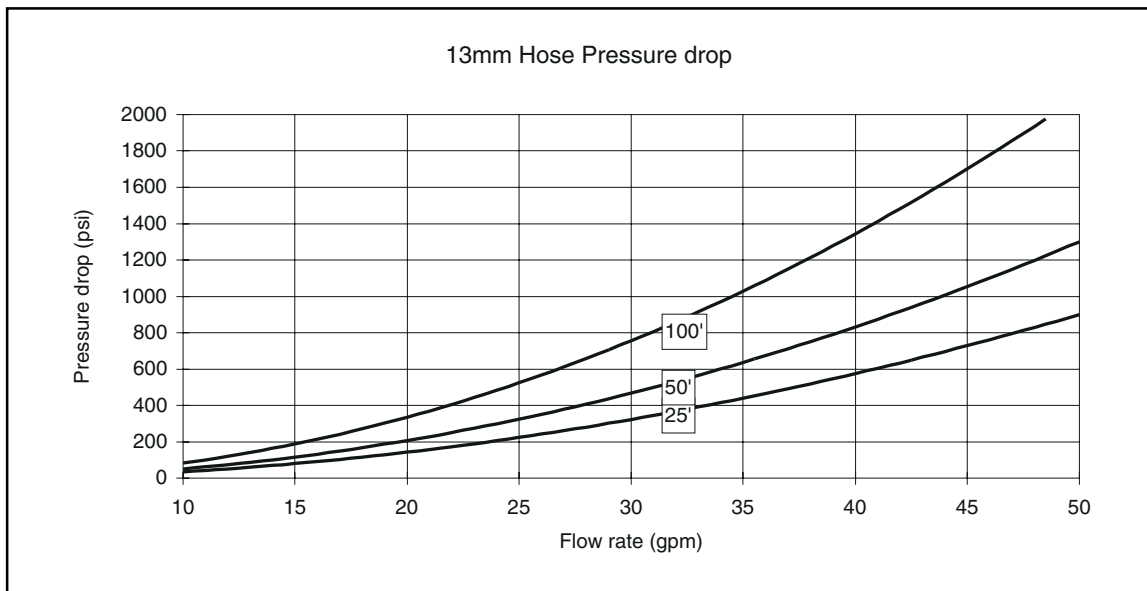

Results obtained from actual pressure drop tests, pumping water through hose assemblies with normal end fittings.

**For Hose Types:**

**2390N-12V03 (2220 ST)**

**2640N-12V32 (6020 ST)**

**2440N-12V37 (4120 ST)**

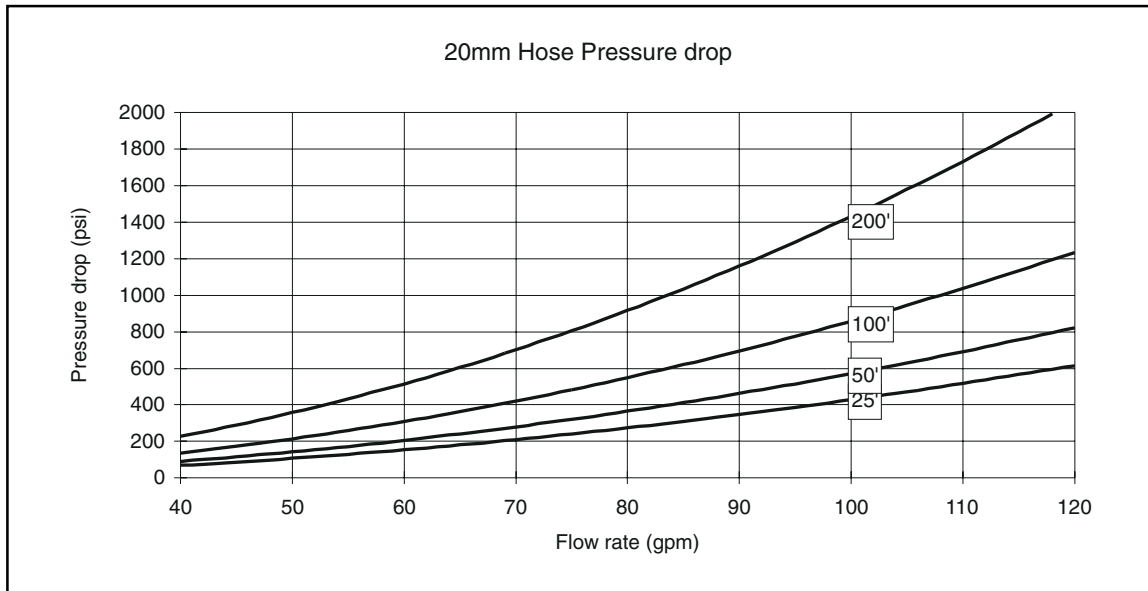

**For Hose Types:**

**2245N-16V30 (2025 ST)**

**2390N-16V13 (2225 ST)**

**2440N-16V37 (4125ST)**

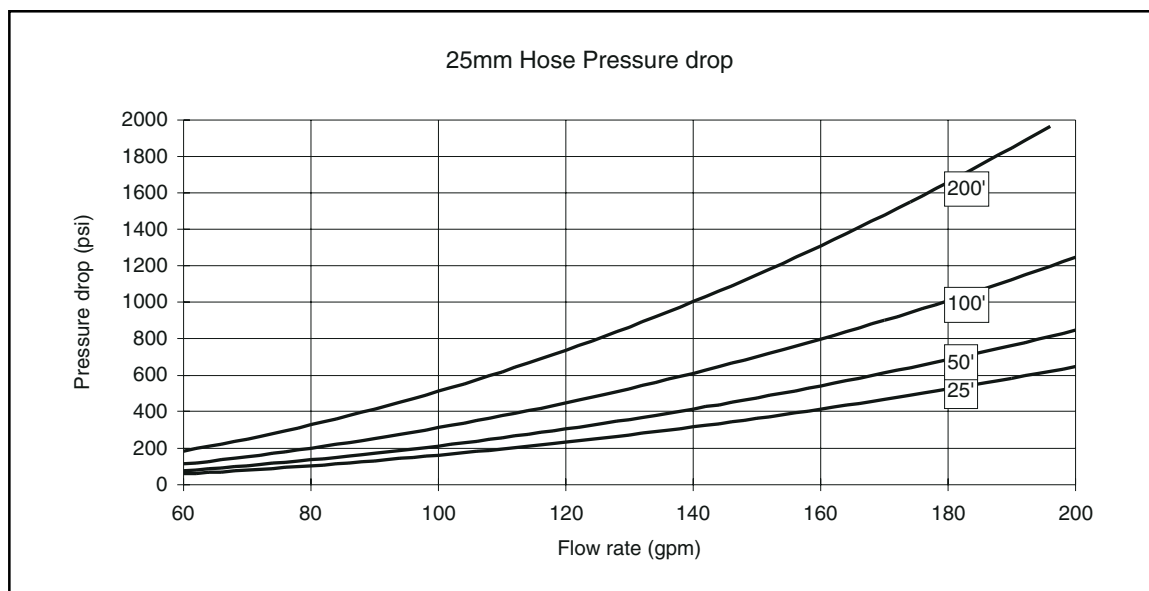

Results obtained from actual pressure drop tests, pumping water through hose assemblies with normal end fittings.

<b>Agency and Specifications</b>	<b>Approved <i>polyflex</i> Products</b>
<b>Hydraulic Service:</b> SAE 100R10	2244N/2380N
<b>DIN (Deutsches Institut Für Normung):</b> DIN 20022 Part 1 (Performance Requirements) DIN 20022 Part 2	2040N 2040H, 2245N/2244N
<b>Electrical Non-Conductivity:</b> SAE J517, Pitman E-00094	HP8
<b>DNV:</b> Cert. No. P-8934, P-8936, P-10271, P-10410 Cert. No. P-9785	HP, HP8 2040N, 2380N



**Abrasion**

Abrasion occurs in numerous forms; two of the more common are the typical rubbing or chafing, with the second being very high frequency, low amplitude friction. This type of abrasion results from pump pressure pulses otherwise known as pump ripple. It can also be caused by equipment vibration or resonance. Abrasion may occur when two hose lines cross or when a hose line rubs or bears against a fixed point. Abrasion resistance is also a function of temperature and attack of the cover material by aggressive chemicals.

Spring guards or other protective sleeving can also ward off premature hose failure resulting from abrasion. Spring guards also distribute bending force often associated with excessive side loading or even kinking at the skirt of the coupling.

**Ambient Temperature**

Exceedingly high or low ambient temperatures will affect the materials from which the hose is constructed and will negatively influence hose life. When at all possible, the hose should be routed in such a manner as to protect it from heat sources. In extreme cold applications, the equipment should be designed with remote relief valves to allow circulation and warming of the oil before hose articulation is attempted. The hose liner (core tube) of choice for extremely high or low temperature is Teflon®. Teflon® is serviceable at temperatures as low as -100°F and as high as +450°. Consult the specific hose operating parameters for more information.

**Bend Radius**

The minimum bend radii listed in this catalog are valid at rated working pressures and indicated service temperatures. Service life of a hose may be shortened if the minimum radius is exceeded or if the hose is flexed continuously in use.

**Burst Pressure and Working Pressure**

The specified burst pressure for each hose style and dash size are for unaged hoses tested at normal laboratory temperature in accordance with SAE J343 specification for normal service and technically ideal installations. The maximum recommended working pressure is 1/4 of the minimum rated burst pressure, except as otherwise specifically stated in those product specifications. For more severe service, a higher rated working pressure hose may have to be selected.

**Hose Installation Tips**

Establish hose size (I. D.) and style based upon flow rate (GPM), pressure drop, and chemical compatibility with fluid medium. Other significant factors to be considered in hose selection and installation are discussed briefly as follows:

**Operating Temperature**

The temperature range for satisfactory service (maximum hose life) depends to a great extent upon the fluid being conveyed. Use of a hose above maximum specified temperature ratings will shorten hose life due, but not limited, to oxidation, chemical degradation and loss of compression within the coupling.

**Pressure Effects**

Pressure surges and system shocks (spikes) are common in hydraulic systems. The normal 4:1 safety factor should reflect these transient pressures. Where these surges and shocks are considered severe or hazardous, the safety factor should be increased.

When hose is under pressure, it may change in length by as much as  $\pm 3\%$ . Installation should compensate for shortening by providing an appropriate amount of slack and for lengthening by allowing space for this growth to be absorbed.

**Routing and Clamping**

Whenever possible, and maximum efforts should be made to do so, hose should be routed to flex in a single plane. Routing hoses in flexure through compound bends results in torsions. When this is unavoidable, the torsion should be distributed over the maximum hose length possible. Wire reinforced hoses suffer the most rapid and severe loss of service life when applied in torsion. Extremely tight and improperly located clamps focus this torsion over short distances.

Analysis of the hose function is required before the proper clamping techniques can be selected. In some applications, hoses must be contained to stay out of harm's way and at the same time be free to come and go with equipment articulation. Other applications may require restrictive clamping, in which case a protective material should be used around the hose to provide the grasp without deformation of the hose by the clamp. These techniques also apply to the use of the popular method of clamping and clustering hoses with plastic tie straps.

Parker swivel adaptors feature 360° swiveling action that especially suits them for use in applications where hose moves, bends or twists. Swivel adaptors connected to hose assemblies relieve twisting, prevent excessive flexing of hose, eliminate need for long radius bends, and cushion intraline shock caused by peak system pressure pulses.

**High Pressure Adapters**

It is critical that the adapter material be properly suited to the fluid media. Widely varying conditions frequently necessitate high pressure adapters constructed of materials other than conventional 316 stainless steel. Since many variables affect the corrosion resistance of metallic materials, it is Parker Hannifin's policy not to recommend materials based on corrosion resistance for specific fluid applications. The published recommended working pressure represent the capability of the subject fitting. Nevertheless, in some instances, the hose, hose fitting or other connector assembled to the adapter may dictate the maximum working pressure. The end-user should read and understand the Parker Safety Guide (Bulletin 4400-B.1) and follow its suggested practices and warnings.



$$\text{Permeability Coefficient} = \frac{V}{A \times T \times p}$$

Where: V is the volume of gas, in cm<sup>3</sup>, which diffuses through a 1mm thickness.

A is the area across which the gas diffuses, in m<sup>2</sup>.

T is the diffusion time, in days.

p is the pressure difference across the plastic, in bar.

### Permeability Coefficients per DIN 53380

Material	Gas				
	N <sub>2</sub>	O <sub>2</sub>	CO <sub>2</sub>	H <sub>2</sub>	He
PTFE	50	150	1500	—	3500
PVDF	3	2	10	—	60
PA-6 XE 3289	1	4	10	100*	60*
PA-6 A 28 NZ	0.5	2	5	50*	30*
PA-12 L 2124	—	30	180	210	160
PA-12 P40 TL	—	—	105	—	—
PA-12 L 25W40	8	35	150	1000*	500*
PA-12 L 2140	—	12	71	—	130
PA-11 P 40 TL	—	—	55	130	—
PA-11 POTL	2	20	65	65	—
POM H 2320	5	10	130	35	40
POM 150 SA	2	4	20	—	—
PEE 4055	150	—	3000	—	1400
PEE 5556	120	—	1600	—	900
PEE 7246	—	—	—	—	300

\* Calculated value. Diffusion constants based on normal room temperature. Actual behavior may vary considerably because of variations in processing the plastic.

**F**

Connection	Thread Sizes	Tightening Torque (ft. Lb)
<b>High Pressure</b>		
1/4"	9/16" - 18thd	25
3/8"	3/4" - 16thd	50
9/16"	1-1/8" - 12thd	75
<b>Medium Pressure</b>		
1/4"	7/16" - 20thd	20
3/8"	9/16" - 18thd	30
9/16"	13/16" - 16thd	85
3/4"	3/4" NPSM	90
1"	1-3/8" - 12thd	125
<b>Type "M" Swivel</b>		
A9	9/16" - 18thd	25-30
A12	3/4" - 16thd	40-50
A14	7/8" - 14thd	50-60
A16	1" - 12thd	75-85
A21	1-5/16" - 12thd	100-120

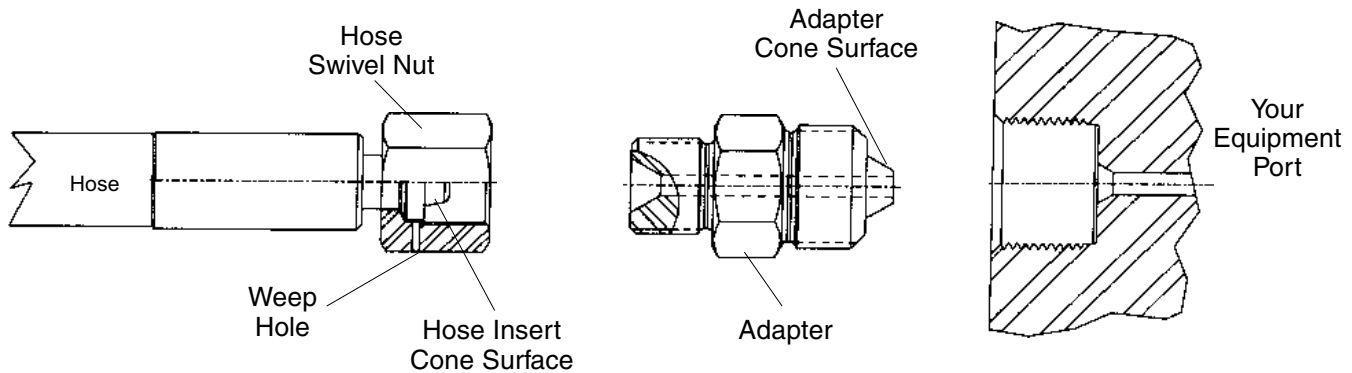

**Leakage at Swivel Nut-to-Adapter Joint**

(Seen by leak at weep hole in swivel nut)

1. Reduce system pressure to zero
2. Unscrew swivel nut and check cone surfaces of adapter and hose insert.
3. If hose insert is damaged, return hose to **polyflex** for repair and retest.
4. If cone surfaces look good after cleaning, re-tighten swivel nut. Do not exceed 150% of recommended torque.

**Leakage at Type "M" Adapter-to-Port**

(Seen by leak at weep hole in pressure port, or leak at threads for NPT adapters.)

1. Reduce system pressure to zero.
2. Slacken Hose Swivel Nut.
3. Tighten Adaptor into Port.
4. Re-tighten Swivel Nut.

Never use the swivel nut to tighten the adapter into the port.

## Metric Conversion Chart

	English to Metric			Metric to English		
	To Convert From	To	Multiply By	To Convert From	To	Multiply By
Area	sq. in. (in <sup>2</sup> )	sq. mm (mm <sup>2</sup> )	645.16	sq. mm (mm <sup>2</sup> )	sq. in. (in <sup>2</sup> )	0.00155
	sq. in. (in <sup>2</sup> )	sq. cm (cm <sup>2</sup> )	6.4516			
	sq. ft. (ft <sup>2</sup> )	sq. meters (m <sup>2</sup> )	0.0929			
Density	pounds/cubic foot (lb/ft <sup>3</sup> )	Kilograms/cubic meter (kg/m <sup>3</sup> )	16.02	Kilograms/cubic meter (kg/m <sup>3</sup> )	pounds/cubic foot (lb/ft <sup>3</sup> )	0.0624
Energy	British Thermal Units (Btu) (1 J = Ws = 0.2388 cal)	joules (J)	1055	joules (J)	British Thermal Units (Btu)	0.000947
Force	pounds - force (lbf) (1N = 0.102 kgf)	newtons (N)	4.448	newtons (N)	pounds - force (lbf)	0.2248
Length	inches (in)	millimeters (mm)	25.4	millimeters (mm)	inches (in)	0.03937
	feet (ft)	meters (m)	0.3048	meters (m)	feet (ft)	3.281
	miles (mi)	kilometers (km)	1.609	kilometers (km)	miles (mi)	0.621
Mass (Weight)	ounces (oz.)	grams (g)	28.35	grams (g)	ounces (oz.)	0.035
	pounds - mass (lb)	kilograms (kg)	0.4536	kilograms (kg)	pounds - mass (lb)	2.205
	short tons (2000 lb) (tn)	metric tons (1000 kg) (t)	0.9072	metric tons (1000 kg) (t)	short tons (2000 lb) (tn)	1.102
Power	horsepower (550 ft. lb/s) (hp)	kilowatts (kW)	0.7457	kilowatts (kW)	horsepower (550 ft. lb/s) (hp)	1.341
Pressure	pounds/square inch (psi)	kilograms (f)/square cm (kg(f)/cm <sup>2</sup> )	0.0703	kilograms (f)/square cm (kg(f)/cm <sup>2</sup> )	pounds/square inch (psi)	14.22
	pounds/square inch (psi)	kilopascals (kPa)	6.8948	kilopascals (kPa)	pounds/square inch (psi)	0.145
	pounds/square inch (psi)	bars (100 kPa)	0.06895	bars (100 kPa)	pounds/square inch (psi)	14.503
Stress	pounds/square inch (psi) (1N/mm <sup>2</sup> = 1MPa)	megapascals (MPa)	0.006895	megapascals (MPa)	pounds/square inch (psi)	145.039
Temperature	degrees Fahrenheit (°F)	degrees Celsius (°C)	5/9 (after subtracting 32)	degrees Celsius (°C)	degrees Fahrenheit (°F)	9/5 (then add 32)
Torque or Bending Moment	pounds-force-foot (lb-ft)	Newtons-meter (Nm)	1.3567	Newtons-meter (Nm)	pounds-force-foot (lb-ft)	0.737
	pounds-force-inch (lb-in)	Newtons-meter (Nm)	0.113	Newtons-meter (Nm)	pounds-force-inch (lb-in)	8.85
Velocity	feet/seconds (ft/s)	meters/second (m/S)	0.3048	meters/second (m/S)	feet/seconds (ft/s)	3.2808
Viscosity	dynamic (centipoise)	Pascal-second (Pas)	0.001	Pascal-second (Pas)	dynamic (centipoise)	1000
	kenematic-foot <sup>2</sup> /sec (ft <sup>2</sup> /s)	meter <sup>2</sup> /sec (m <sup>2</sup> /s)	0.0929	meter <sup>2</sup> /sec (m <sup>2</sup> /s)	kenematic-foot <sup>2</sup> /sec (ft <sup>2</sup> /s)	10.7643
Volume	cubic inch (in <sup>3</sup> )	cubic centimeter (cm <sup>3</sup> ) (milliliter)	16.3871	cubic centimeter (cm <sup>3</sup> ) (milliliter)	cubic inch (in <sup>3</sup> )	0.061
	quarts (qt)	liters (1000 cm <sup>3</sup> )	0.9464	liters (1000 cm <sup>3</sup> )	quarts (qt)	1.057
	gallons (gal)	liters	3.7854	liters	gallons (gal)	0.2642



**Ratings Code:**

- G** – Good to excellent. Little or no swelling, tensile or surface changes. Preferred choice.
- L** – Marginal or conditional. Noticeable effects but not necessarily indicating lack of serviceability. Further testing suggested for specific application. Very long-term effects such as stiffening or potential for crazing should be evaluated.
- P** – Poor or unsatisfactory. Not recommended without extensive and realistic testing.
- – Indicates that this was not tested.
- # – For Teflon. Indicates good chemical resistance but potential for excessive permeation.

Polyester Elastomer "H" Core Tube	Polyamide "N" Core Tube	Polyoxy-methylene "POM" Core Tube	Fluorinated-ethylene "F" Core Tube	Polyurethane "U" Hose Covers	Polyester Elastomer "H" Hose Covers	Polyamide "N" Hose Covers
2040H	2020N	2240D	2380F	2040N		2020N
2370H	2040N	2243D		2244N		2240D
	2244N	2245D		2245N		2243D
	2245N	2440D		2380F		2245D
	2380N	2640D		2380N		2245N-8
	2390N	2740D		2390N		2245N-12
	2440N	2840D		2440N-32V10		2245N-16
	2640N			2640N-32V80		2380N-04V33
	2X90N			2X90N		2440D
						2440N
						2640D
						2640N
						2740D
						2840D

**Notes on the Chemical Resistance Table**

- The fluid resistance tables are simplified rating tabulations based on immersion tests at 24° C. Higher temperatures tend to reduce ratings. **Since final selection depends on pressure, fluid and ambient temperature and other factors not known to Parker Hannifin, no performance guarantee is expressed or implied.** The indications do not imply any compliance with standards and regulations and do not refer to possible changes of colour, taste or smell. For food and drinking water specially approved materials have to be used. For fluids not listed or for advice on particular applications, please consult Parker Hannifin, Polyflex in Stafford, TX.
- Hose applications for these fluids must take into account legal and insurance regulations. The chemical resistance indicated does not express or imply approval by certain institutions.
- Satisfactory at some concentrations and temperatures, unsatisfactory at others.
- For gas applications, the cover should be pin-pricked and the pressure must not be released quickly. Special safety guard accessories are to be used to prevent damage or personal injury in the event of failure..
- Chemical resistance does not imply low permeation rates. Please consult Parker Hannifin for a recommendation for your specific requirements.
- The indication of chemical resistance does not imply any special food compatibility; it refers only to the chemical resistance of the material.
- Chemical resistance does not imply acceptability for use in airless paintspray applications. These applications require a special, electrically conductive hose.

Chemical	H	N	U	POM	FEP
Acetaldehyde	G	L	L	—	G
Acetic Acid Glacial	L	L	L	—	L
Acetone	L	G	P	L	G
Acetylene	2	2	2	—	2
Air (4)	G	G	G	G	G
Ammonium Chloride	G	P	G	—	L
Ammonium Hydroxide	L	G	P	—	G
Anhydrous Ammonia	P	P	P	—	8
Aniline	P	P	P	—	G
Animal Oils (6)	G	G	G	—	—
Aromatic Hydrocarbons	L	G	L	—	—
Asphalt	G	G	G	—	L
Baygon (insecticide)	L	G	P	—	—
Beer	G	G	G	—	G
Benzene	L	G	L	—	G
Brake Fluid (DOT #3)	—	G	P	L	—
Butane (2) (4)	G	G	L	—	#
Butter (6)	G	G	G	—	—
Calcium Chloride	G	3	G	—	G
Carbon Dioxide (4)	G	G	G	—	#
Carbon Monoxide (4)	G	3	G	—	#
Carbon Tetrachloride	L	G	P	—	G
Castor Oil	G	L	L	—	—
Chlordane (Insecticide)	L	G	P	—	—
Chlorinated Hydrocarbon Base Fluids	L	G	L	—	—
Chlorinated Petroleum Oil	G	G	L	—	—
Chlorinated Solvents	P	3	P	—	#
Chlorine, Gaseous, Dry	P	P	P	—	—
Chloroform	P	P	P	—	G
Chromic Acid	P	3	P	—	L
Citric Acid Solutions	G	G	L	—	G
Crude Petroleum Oil	G	G	G	G	—
Cyclohexane (2)	G	G	G	—	G
Cygon (Insecticide)	L	G	P	—	—
Diazion (insecticide)	L	G	P	—	—
Diesel Fuel (2)	G	G	G	G	—
Diester Oils	L	G	P	—	—
Enamels	G	G	G	—	—
Ethanol (6)	G	G	L	G	—
Ethers	L	G	P	P	G
Ethylene Glycol	G	G	L	G	G
Ethylene Oxide	G	G	L	—	#
Fatty Acids	G	G	3	—	G
Formaldehyde	L	L	P	—	G
Formic Acid J	P	P	P	—	G

**F**

Chemical	H	N	U	POM	FEP
Freon 12 (5)	P	G	L	—	#
Freon 22 (5)	P	G	L	—	#
Fruit Juices	G	G	G	—	—
Fuel Oil (2)	G	G	L	G	G
Gas (Oil) (2)	G	G	G	—	—
Gas (Natural) (4)	—	—	—	—	2
Gasoline (2)	G	G	3	—	G
Glue	3	3	3	—	3
Glycerin	G	G	L	—	G
Glycols (to 135°F)	G	G	L	G	G
Grease (petroleum base)	G	G	G	G	—
Heptachlor (insecticide)	L	G	P	—	—
Hexane (2)	G	G	G	—	G
Houghto Safe-600 Series (hydraulic fluid)	—	G	L	—	—
Houghto Safe-1000 Series (phosphate esters)	L	G	P	—	—
Hydraulic Fluid (petroleum base)	G	G	G	G	L
Hydraulic Fluid (phosphate ester base)	L	G	L	—	—
Hydraulic Fluid (water glycol base)	G	G	G	—	—
Hydraulic Oil (petroleum base)	G	G	G	G	L
Hydrochloric Acid	P	L	P	—	G
Hydrofluoric Acid	P	P	P	—	G
Hydrogen, Gaseous (2) (4) (5)	G	G	G	—	#
Hydrolube (hydraulic fluid/water glycol base)	—	G	L	—	—
IRUS 902 (hydraulic fluid/water-oil emulsion)	G	G	G	—	—
Isocyanates (2)	L	L	L	—	—
IsoOctane (2)	G	G	G	—	G
Isopropyl Alcohol	G	G	L	—	G
Kerosene (2)	G	G	L	—	G
Ketones	L	G	P	—	G
Lacquer Solvents	L	G	P	—	L
Lactic Acid	P	G	P	—	G
Lime (calcium oxide)	G	G	G	—	G
Lindol (hydraulic fluid/phosphate esters)	—	G	P	—	—
Linseed Oil	G	G	G	G	G
LP - Gas	2	2	2	—	2
Lubricating Oils (diester base)	L	G	P	—	—
Lubricating Oils (petroleum base)	G	G	G	G	G
Magnesium Hydroxide	L	G	L	—	G
Magnesium Salts	—	G	G	—	—
Malathion (insecticide)	L	G	P	—	—

Chemical	H	N	U	POM	FEP
Mercury	G	G	G	—	G
Meropa Oil (sulphur base)	G	G	—	—	—
Methane	2	2	2	—	2
Methanol	G	G	P	—	—
Methoxychlor (insecticide)	L	G	P	—	—
Methyl Alcohol (6)	G	G	P	G	G
Methylene Chloride	—	—	—	—	G
Methyl Ethyl Ketone (MEK)	L	G	P	L	G
Methyl Ethyl Ketone Peroxide (MEKP)	—	L	P	—	—
Methyl Isobutyl Ketone (MIBK)	L	G	P	—	G
Methylene Chloride	P	L	P	P	
Milk (6)	G	G	G	—	G
Mineral Oil	G	G	G	G	G
Mineral Spirits	P	—	L	—	—
Motor Oils	G	G	G	—	G
Naphtha	L	G	P	G	G
Natural Gas (4)	2	2	2	—	2
Nitric Acid	P	P	P	—	L
Nitrobenzene	P	G	P	—	G
Nitrogen, Gaseous (4) (5)	G	G	G	—	G
Nitrous Oxide	—	L	—	—	#
Oil (SAE)	G	G	G	G	—
Oil of Turpentine	G	G	P	—	—
Oleic Acid	G	G	G	—	G
OS 45 Type 3 Hydraulic Fluid (silicate esters)	L	G	L	—	—
Oxygen, Gaseous (4) (5) (6)	G	G	G	—	G
Ozone	L	P	L	—	G
Paint (Oil Base) (7)	G	G	G	—	—
Paint Solvents (oil base)	L	G	L	—	—
Pentane (2)	G	G	L	—	G
Perchloric Acid	P	P	P	—	L
Perchloroethylene	P	P	P	L	—
Petroleum Ether	—	2	2	—	2
Petroleum Oils	G	G	G	—	—
Phenols	P	P	P	—	—
Phosphate Esters (above 135°F)	P	G	P	—	—
Phosphate Esters (to 135°F)	G	G	P	—	—
Polyol Esters	L	G	P	—	—
Potassium Hydroxide, 50%	P	P	P	—	G
Propane (4) (5)	2	2	2	—	2
Propylene Glycol	—	—	G	—	G
Pydraul 312C, 625 (to 135°F)	P	G	P	—	—
Pydraul F-9, 150, 160 (to 135°F)	G	G	P	—	—
Quintolubric 822 Fluid	—	G	G	—	—

F

Chemical	H	N	U	POM	FEP
Salt Water	3	3	3	—	G
Sevin (insecticides in water)	G	G	G	—	—
Silicone Greases	G	G	G	—	—
Silicone Oils	G	G	G	—	—
Skydrol 500 & 7000	L	G	P	—	G
Soap Solutions	G	G	G	—	G
Soda Water	G	G	G	—	—
Sodium Borate	G	G	G	—	G
Sodium Carbonate	3	3	3	—	3
Sodium Chloride Solutions	G	G	G	—	G
Sodium Hydroxide, 50%	L	P	P	—	G
Sodium Hypochlorite	L	P	P	—	G
Steam	P	P	P	—	G
Stoddard Solvent	P	G	P	—	G
Straight Synthetic Oils (phosphate esters)	L	G	P	—	—
Sulfur	G	G	G	—	G
Sulfur Dioxide	P	L	L	—	G
Sulfur Hexafluoride Gas (4) (5)	G	G	G	—	—
Sulphuric Acid	P	P	P	—	—
Toluol, Toluene	L	G	L	G	G
Toluol	L	G	L	—	—
Transmission Fluid	G	G	G	L	—
Trichloroethylene	P	L	P	—	G
Trisodium Phosphate Solutions	L	G	P	—	G
Turpentine	G	G	L	—	G
Ucon (hydraulic fluid-water glycol base)	G	G	L	—	—
Varnish	G	G	G	G	—
Vinegar (6)	L	G	L	—	G
Water (to 135°F) (6)	G	G	G	G	G
Water (above 135°F) (6)	P	G	P	—	L
Water Glycols (to 135°F)	G	G	L	—	—
Water Glycols (above 135°F)	P	G	P	—	—
Water in oil Emulsions (to 135°F)	G	G	L	G	—
Water in oil Emulsions (above 135°F)	P	G	P	—	—
Whiskey, Wines (6)	G	G	L	—	G
Wood Oils	G	G	L	G	—
Xylene	L	G	P	G	G
Zinc Chloride	G	G	G	—	G



## Parker Safety Guide for Selecting and Using Hose, Tubing, Fittings, and Related Accessories

Parker Publication No. 4400-B.1  
Revised: May 2002

**WARNING:** Failure or improper selection or improper use of hose, tubing, fittings, assemblies or related accessories (“Products”) can cause death, personal injury and property damage. Possible consequences of failure or improper selection or improper use of these Products include but are not limited to:

- Fittings thrown off at high speed.
- High velocity fluid discharge.
- Explosion or burning of the conveyed fluid.
- Electrocutation from high voltage electric power lines.
- Contact with suddenly moving or falling objects that are controlled by the conveyed fluid.
- Injections by high-pressure fluid discharge.
- Dangerously whipping Hose.
- Contact with conveyed fluids that may be hot, cold, toxic or otherwise injurious.
- Sparking or explosion caused by static electricity buildup or other sources of electricity.
- Sparking or explosion while spraying paint or flammable liquids.
- Injuries resulting from inhalation, ingestion or exposure to fluids.

Before selecting or using any of these Products, it is important that you read and follow the instructions below. Only Hose from Parker's Stratoflex Products Division is approved for in flight aerospace applications, and no other Hose can be used for such in flight applications.

### 1.0 GENERAL INSTRUCTIONS

**1.1 Scope:** This safety guide provides instructions for selecting and using (including assembling, installing, and maintaining) these Products. For convenience, all rubber and/or thermoplastic products commonly called “hose” or “tubing” are called “Hose” in this safety guide. All assemblies made with Hose are called “Hose Assemblies”. All products commonly called “fittings” or “couplings” are called “Fittings”. All related accessories (including crimping and swaging machines and tooling) are called “Related Accessories”. This safety guide is a supplement to and is to be used with, the specific Parker publications for the specific Hose, Fittings and Related Accessories that are being considered for use.

**1.2 Fail-Safe:** Hose, and Hose Assemblies and Fittings can and do fail without warning for many reasons. Design all systems and equipment in a fail-safe mode, so that failure of the Hose or Hose Assembly or Fitting will not endanger persons or property.

**1.3 Distribution:** Provide a copy of this safety guide to each person that is responsible for selecting or using Hose and Fitting products. Do not select or use Parker Hose or Fittings without thoroughly reading and understanding this safety guide as well as the specific Parker publications for the products considered or selected.

**1.4 User Responsibility:** Due to the wide variety of operating conditions and applications for Hose and Fittings, Parker and its distributors do not represent or warrant that any particular Hose or Fitting is suitable for any specific end use system. This safety guide does not analyze all technical parameters that must be considered in selecting a product. The user, through its own analysis and testing, is solely responsible for:

- Making the final selection of the Hose and Fitting.
- Assuring that the user's requirements are met and that the application presents no health or safety hazards.
- Providing all appropriate health and safety warnings on the equipment on which the Hose and Fittings are used.
- Assuring compliance with all applicable government and industry standards.

**1.5 Additional Questions:** Call the appropriate Parker technical service department if you have any questions or require any additional information. See the Parker publication for the product being considered or used, or call 1-800-CPARKER, or go to [www.parker.com](http://www.parker.com), for telephone numbers of the appropriate technical service department.

### 2.0 HOSE AND FITTING SELECTION INSTRUCTIONS

**2.1 Electrical Conductivity:** Certain applications require that the Hose be nonconductive to prevent electrical current flow. Other applications require the Hose and the Fitting and the Hose/Fitting interface to be sufficiently conductive to drain off static electricity. Extreme care must be exercised when selecting Hose and Fittings for these or any other applications in which electrical conductivity or nonconductivity is a factor.

The electrical conductivity or nonconductivity of Hose and Fittings is dependent upon many factors and may be susceptible to change. These factors include but are not limited to the various materials used to make the Hose and the Fittings, Fitting finish (some Fitting finishes are electrically conductive while others are nonconductive), manufacturing methods (including moisture control), how the Fittings contact the Hose, age and amount of deterioration or damage or other changes, moisture content of the Hose at any particular time, and other factors.

The following are considerations for electrically nonconductive and conductive Hose. For other applications consult the individual catalog pages and the appropriate industry or regulatory standards for proper selection.

**2.1.1 Electrically Nonconductive Hose:** Certain applications require that the Hose be nonconductive to prevent electrical current flow or to maintain electrical isolation. For these applications that require Hose to be electrically nonconductive, including but not limited to applications near high voltage electric lines, only special nonconductive Hose can be used. The manufacturer of the equipment in which the nonconductive Hose is to be used must be consulted to be certain that the Hose and Fittings that are selected are proper for the application. Do not use any Parker Hose or Fitting for any such application requiring nonconductive Hose, including but not limited to applications near high voltage electric lines, unless (i) the application is expressly approved in the Parker technical publication for the product, (ii) the Hose is marked “nonconductive”, and (iii) the manufacturer of the equipment on which the Hose is to be used specifically approves the particular Parker Hose and Fitting for such use.

**2.1.2 Electrically Conductive Hose:** Parker manufactures special Hose for certain applications that require electrically conductive Hose.

Parker manufactures special Hose for conveying paint in airless paint spraying applications. This Hose is labeled “Electrically Conductive Airless Paint Spray Hose” on its layline and packaging. This Hose must be properly connected to the appropriate Parker Fittings and properly grounded in order to dissipate dangerous static charge buildup, which occurs in all airless paint spraying applications. Do not use any other Hose for airless paint spraying, even if electrically conductive. Use of any other Hose or failure to properly connect the Hose can cause a fire or an explosion resulting in death, personal injury, and property damage.

Parker manufactures a special Hose for certain compressed natural gas (“CNG”) applications where static electricity buildup may occur. Parker CNG Hose assemblies comply with AGA Requirements 1-93, “Hoses for Natural Gas Vehicles and Fuel Dispensers”. This Hose is labeled “Electrically Conductive for CNG Use” on its layline and packaging. This Hose must be properly connected to the appropriate Parker Fittings and properly grounded in order to dissipate dangerous static charge buildup, which occurs in, for example, high velocity CNG dispensing or transfer. Do not use any other Hose for CNG applications where static charge buildup may occur, even if electrically conductive. Use of other Hoses in CNG applications or failure to properly connect or ground this Hose can cause a fire or an explosion resulting in death, personal injury, and property damage. Care must also be taken to protect against CNG permeation through the Hose wall. See section 2.6, Permeation, for more information. Parker CNG Hose is intended for dispenser and vehicle use at a maximum temperature of 180°F. Parker CNG Hose should not be used in confined spaces or unventilated areas or areas exceeding 180°F. Final assemblies must be tested for leaks. CNG Hose Assemblies should be tested on a monthly basis for conductivity per AGA 1-93.

Parker manufactures special Hose for aerospace in-flight applications. Aerospace in-flight applications employing Hose to transmit fuel, lubricating fluids and hydraulic fluids require a special Hose with a conductive inner tube. This Hose for in-flight applications is available only from Parker's Stratoflex Products Division. Do not use any other Parker Hose for in-flight applications, even if electrically conductive. Use of other Hoses for in-flight applications or failure to properly connect or ground this Hose can cause a fire or

F

an explosion resulting in death, personal injury, and property damage. These Hose assemblies for in-flight applications must meet all applicable aerospace industry, aircraft engine, and aircraft requirements.

- 2.2 Pressure:** Hose selection must be made so that the published maximum recommended working pressure of the Hose is equal to or greater than the maximum system pressure. Surge pressures or peak transient pressures in the system must be below the published maximum working pressure for the Hose. Surge pressures and peak pressures can usually only be determined by sensitive electrical instrumentation that measures and indicates pressures at millisecond intervals. Mechanical pressure gauges indicate only average pressures and cannot be used to determine surge pressures or peak transient pressures. Published burst pressure ratings for Hose is for manufacturing test purposes only and is no indication that the Product can be used in applications at the burst pressure or otherwise above the published maximum recommended working pressure.
- 2.3 Suction:** Hoses used for suction applications must be selected to insure that the Hose will withstand the vacuum and pressure of the system. Improperly selected Hose may collapse in suction application.
- 2.4 Temperature:** Be certain that fluid and ambient temperatures, both steady and transient, do not exceed the limitations of the Hose. Temperatures below and above the recommended limit can degrade Hose to a point where a failure may occur and release fluid. Properly insulate and protect the Hose Assembly when routing near hot objects (e.g. manifolds). Do not use any Hose in any application where failure of the Hose could result in the conveyed fluids (or vapors or mist from the conveyed fluids) contacting any open flame, molten metal, or other potential fire ignition source that could cause burning or explosion of the conveyed fluids or vapors.
- 2.5 Fluid Compatibility:** Hose Assembly selection must assure compatibility of the Hose tube, cover, reinforcement, and Fittings with the fluid media used. See the fluid compatibility chart in the Parker publication for the product being considered or used. This information is offered only as a guide. Actual service life can only be determined by the end user by testing under all extreme conditions and other analysis.
- Hose that is chemically compatible with a particular fluid must be assembled using Fittings and adapters containing likewise compatible seals.
- 2.6 Permeation:** Permeation (that is, seepage through the Hose) will occur from inside the Hose to outside when Hose is used with gases, liquid and gas fuels, and refrigerants (including but not limited to such materials as helium, diesel fuel, gasoline, natural gas, or LPG). This permeation may result in high concentrations of vapors which are potentially flammable, explosive, or toxic, and in loss of fluid. Dangerous explosions, fires, and other hazards can result when using the wrong Hose for such applications. The system designer must take into account the fact that this permeation will take place and must not use Hose if this permeation could be hazardous. The system designer must take into account all legal, government, insurance, or any other special regulations which govern the use of fuels and refrigerants. Never use a Hose even though the fluid compatibility is acceptable without considering the potential hazardous effects that can result from permeation through the Hose Assembly.
- Permeation of moisture from outside the Hose to inside the Hose will also occur in Hose assemblies, regardless of internal pressure. If this moisture permeation would have detrimental effects (particularly, but not limited to refrigeration and air conditioning systems), incorporation of sufficient drying capacity in the system or other appropriate system safeguards should be selected and used.
- 2.7 Size:** Transmission of power by means of pressurized fluid varies with pressure and rate of flow. The size of the components must be adequate to keep pressure losses to a minimum and avoid damage due to heat generation or excessive fluid velocity.
- 2.8 Routing:** Attention must be given to optimum routing to minimize inherent problems (kinking or flow restriction due to Hose collapse, twisting of the Hose, proximity to hot objects or heat sources).
- 2.9 Environment:** Care must be taken to insure that the Hose and Fittings are either compatible with or protected from the environment (that is, surrounding conditions) to which they are exposed. Environmental conditions including but not limited to ultraviolet radiation, sunlight, heat, ozone, moisture, water, salt water, chemicals, and air pollutants can cause degradation and premature failure.
- 2.10 Mechanical Loads:** External forces can significantly reduce Hose life or cause failure. Mechanical loads which must be considered include excessive flexing, twist, kinking, tensile or side loads, bend radius, and vibration. Use of swivel type Fittings or adapters may be required to insure no twist is put into the Hose. Unusual applications may require special testing prior to Hose selection.
- 2.11 Physical Damage:** Care must be taken to protect Hose from wear, snagging, kinking, bending smaller than minimum bend radius, and cutting, any

of which can cause premature Hose failure. Any Hose that has been kinked or bent to a radius smaller than the minimum bend radius, and any Hose that has been cut or is cracked or is otherwise damaged, should be removed and discarded.

- 2.12 Proper End Fitting:** See instructions 3.2 through 3.5. These recommendations may be substantiated by testing to industry standards such as SAE J517 for hydraulic applications, or MIL-A-5070, AS1339, or AS3517 for Hoses from Parker's Stratoflex Products Division for aerospace applications.
- 2.13 Length:** When establishing a proper Hose length, motion absorption, Hose length changes due to pressure, and Hose and machine tolerances and movement must be considered.
- 2.14 Specifications and Standards:** When selecting Hose and Fittings, government, industry, and Parker specifications and recommendations must be reviewed and followed as applicable.
- 2.15 Hose Cleanliness:** Hose components may vary in cleanliness levels. Care must be taken to insure that the Hose Assembly selected has an adequate level of cleanliness for the application.
- 2.16 Fire Resistant Fluids:** Some fire resistant fluids that are to be conveyed by Hose require use of the same type of Hose as used with petroleum base fluids. Some such fluids require a special Hose, while a few fluids will not work with any Hose at all. See instructions 2.5 and 1.5. The wrong Hose may fail after a very short service. In addition, all liquids but pure water may burn fiercely under certain conditions, and even pure water leakage may be hazardous.
- 2.17 Radiant Heat:** Hose can be heated to destruction without contact by such nearby items as hot manifolds or molten metal. The same heat source may then initiate a fire. This can occur despite the presence of cool air around the Hose.
- 2.18 Welding or Brazing:** When using a torch or arc welder in close proximity to hydraulic lines, the hydraulic lines should be removed or shielded with appropriate fire resistant materials. Flame or weld spatter could burn through the Hose and possibly ignite escaping fluid resulting in a catastrophic failure. Heating of plated parts, including Hose Fittings and adapters, above 450°F (232°C) such as during welding, brazing, or soldering may emit deadly gases.
- 2.19 Atomic Radiation:** Atomic radiation affects all materials used in Hose assemblies. Since the long-term effects may be unknown, do not expose Hose assemblies to atomic radiation.
- 2.20 Aerospace Applications:** The only Hose and Fittings that may be used for in-flight aerospace applications are those available from Parker's Stratoflex Products Division. Do not use any other Hose or Fittings for in-flight applications. Do not use any Hose or Fittings from Parker's Stratoflex Products Division with any other Hose or Fittings, unless expressly approved in writing by the engineering manager or chief engineer of Stratoflex Products Division and verified by the user's own testing and inspection to aerospace industry standards.
- 2.21 Unlocking Couplings:** Ball locking couplings or other couplings with disconnect sleeves can unintentionally disconnect if they are dragged over obstructions or if the sleeve is bumped or moved enough to cause disconnect. Threaded couplings should be considered where there is a potential for accidental uncoupling.
- 3.0 HOSE AND FITTING ASSEMBLY AND INSTALLATION INSTRUCTIONS**
- 3.1 Component Inspection:** Prior to assembly, a careful examination of the Hose and Fittings must be performed. All components must be checked for correct style, size, catalog number, and length. The Hose must be examined for cleanliness, obstructions, blisters, cover looseness, kinks, cracks, cuts or any other visible defects. Inspect the Fitting and sealing surfaces for burrs, nicks, corrosion or other imperfections. Do NOT use any component that displays any signs of nonconformance.
- 3.2 Hose and Fitting Assembly:** Do not assemble a Parker Fitting on a Parker Hose that is not specifically listed by Parker for that Fitting, unless authorized in writing by the engineering manager or chief engineer of the appropriate Parker division. Do not assemble a Parker Fitting on another manufacturer's Hose or a Parker Hose on another manufacturer's Fitting unless (i) the engineering manager or chief engineer of the appropriate Parker division approves the Assembly in writing or that combination is expressly approved in the appropriate Parker literature for the specific Parker product, and (ii) the user verifies the Assembly and the application through analysis and testing. For Parker Hose that does not specify a Parker Fitting, the user is solely responsible for the selection of the proper Fitting and Hose Assembly procedures. See instruction 1.4.

The Parker published instructions must be followed for assembling the Fittings on the Hose. These instructions are provided in the Parker Fitting catalog for the specific Parker Fitting being used, or by calling 1-800-CPARKER, or at [www.parker.com](http://www.parker.com).

- 3.3 Related Accessories:** Do not crimp or swage any Parker Hose or Fitting with anything but the listed swage or crimp machine and dies in accordance with Parker published instructions. Do not crimp or swage another manufacturer's Fitting with a Parker crimp or swage die unless authorized in writing by the engineering manager or chief engineer of the appropriate Parker division.
- 3.4 Parts:** Do not use any Parker Fitting part (including but not limited to socket, shell, nipple, or insert) except with the correct Parker mating parts, in accordance with Parker published instructions, unless authorized in writing by the engineering manager or chief engineer of the appropriate Parker division.
- 3.5 Reusable/Permanent:** Do not reuse any field attachable (reusable) Hose Fitting that has blown or pulled off a Hose. Do not reuse a Parker permanent Hose Fitting (crimped or swaged) or any part thereof. Complete Hose Assemblies may only be reused after proper inspection under section 4.0. Do not assemble Fittings to any previously used hydraulic Hose that was in service, for use in a fluid power application.
- 3.6 Pre-Installation Inspection:** Prior to installation, a careful examination of the Hose Assembly must be performed. Inspect the Hose Assembly for any damage or defects. Do NOT use any Hose Assembly that displays any signs of nonconformance.
- 3.7 Minimum Bend Radius:** Installation of a Hose at less than the minimum listed bend radius may significantly reduce the Hose life. Particular attention must be given to preclude sharp bending at the Hose to Fitting juncture. Any bending during installation at less than the minimum bend radius must be avoided. If any Hose is kinked during installation, the Hose must be discarded.
- 3.8 Twist Angle and Orientation:** Hose Assembly installation must be such that relative motion of machine components does not produce twisting.
- 3.9 Securement:** In many applications, it may be necessary to restrain, protect, or guide the Hose to protect it from damage by unnecessary flexing, pressure surges, and contact with other mechanical components. Care must be taken to insure such restraints do not introduce additional stress or wear points.
- 3.10 Proper Connection of Ports:** Proper physical installation of the Hose Assembly requires a correctly installed port connection insuring that no twist or torque is transferred to the Hose when the Fittings are being tightened or otherwise during use.
- 3.11 External Damage:** Proper installation is not complete without insuring that tensile loads, side loads, kinking, flattening, potential abrasion, thread damage, or damage to sealing surfaces are corrected or eliminated. See instruction 2.10.
- 3.12 System Checkout:** All air entrapment must be eliminated and the system pressurized to the maximum system pressure (at or below the Hose maximum working pressure) and checked for proper function and freedom from leaks. Personnel must stay out of potential hazardous areas while testing and using.
- 3.13 Routing:** The Hose Assembly should be routed in such a manner so if a failure does occur, the escaping media will not cause personal injury or property damage. In addition, if fluid media comes in contact with hot surfaces, open flame, or sparks, a fire or explosion may occur. See section 2.4.
- 4.0 HOSE AND FITTING MAINTENANCE AND REPLACEMENT INSTRUCTIONS**
- 4.1** Even with proper selection and installation, Hose life may be significantly reduced without a continuing maintenance program. The severity of the application, risk potential from a possible Hose failure, and experience with any Hose failures in the application or in similar applications should determine the frequency of the inspection and the replacement for the Products so that Products are replaced before any failure occurs. A maintenance program must be established and followed by the user and, at minimum, must include instructions 4.2 through 4.7.
- 4.2 Visual Inspection Hose/Fitting:** Any of the following conditions require immediate shut down and replacement of the Hose Assembly:
- Fitting slippage on Hose;
  - Damaged, cracked, cut or abraded cover (any reinforcement exposed);
  - Hard, stiff, heat cracked, or charred Hose;
  - Cracked, damaged, or badly corroded Fittings;
  - Leaks at Fitting or in Hose;
  - Kinked, crushed, flattened or twisted Hose; and
  - Blistered, soft, degraded, or loose cover.
- 4.3 Visual Inspection All Other:** The following items must be tightened, repaired, corrected or replaced as required:
- Leaking port conditions;
  - Excess dirt buildup;
  - Worn clamps, guards or shields; and
  - System fluid level, fluid type, and any air entrapment.
- 4.4 Functional Test:** Operate the system at maximum operating pressure and check for possible malfunctions and leaks. Personnel must avoid potential hazardous areas while testing and using the system. See section 2.2.
- 4.5 Replacement Intervals:** Hose assemblies and elastomeric seals used on Hose Fittings and adapters will eventually age, harden, wear and deteriorate under thermal cycling and compression set. Hose Assemblies and elastomeric seals should be inspected and replaced at specific replacement intervals, based on previous service life, government or industry recommendations, or when failures could result in unacceptable downtime, damage, or injury risk. See section 1.2.
- 4.6 Hose Inspection and Failure:** Hydraulic power is accomplished by utilizing high-pressure fluids to transfer energy and do work. Hoses, Fittings, and Hose Assemblies all contribute to this by transmitting fluids at high pressures. Fluids under pressure can be dangerous and potentially lethal and, therefore, extreme caution must be exercised when working with fluids under pressure and handling the Hoses transporting the fluids. From time to time, Hose Assemblies will fail if they are not replaced at proper time intervals. Usually these failures are the result of some form of misapplication, abuse, wear, or failure to perform proper maintenance. When Hoses fail, generally the high-pressure fluids inside escape in a stream which may or may not be visible to the user. Under no circumstances should the user attempt to locate the leak by "feeling" with their hands or any other part of their body. High-pressure fluids can and will penetrate the skin and cause severe tissue damage and possibly loss of limb. Even seemingly minor hydraulic fluid injection injuries must be treated immediately by a physician with knowledge of the tissue damaging properties of hydraulic fluid.
- If a Hose failure occurs, immediately shut down the equipment and leave the area until pressure has been completely released from the Hose Assembly. Simply shutting down the hydraulic pump may or may not eliminate the pressure in the Hose Assembly. Many times check valves, etc., are employed in a system and can cause pressure to remain in a Hose Assembly even when pumps or equipment are not operating. Tiny holes in the Hose, commonly known as pinholes, can eject small, dangerously powerful but hard to see streams of hydraulic fluid. It may take several minutes or even hours for the pressure to be relieved so that the Hose Assembly may be examined safely.
- Once the pressure has been reduced to zero, the Hose Assembly may be taken off the equipment and examined. It must always be replaced if a failure has occurred. Never attempt to patch or repair a Hose Assembly that has failed. Consult the nearest Parker distributor or the appropriate Parker division for Hose Assembly replacement information.
- Never touch or examine a failed Hose Assembly unless it is obvious that the Hose no longer contains fluid under pressure. The high-pressure fluid is extremely dangerous and can cause serious and potentially fatal injury.
- 4.7 Elastomeric seals:** Elastomeric seals will eventually age, harden, wear and deteriorate under thermal cycling and compression set. Elastomeric seals should be inspected and replaced.
- 4.8 Refrigerant gases:** Special care should be taken when working with refrigeration systems. Sudden escape of refrigerant gases can cause blindness if the escaping gases contact the eye and can cause freezing or other severe injuries if it contacts any other portion of the body.
- 4.9 Compressed natural gas (CNG):** Parker CNG Hose Assemblies should be tested after installation and before use, and at least on a monthly basis per AGA 1-93 Section 4.2 "Visual Inspection Hose/Fitting". The recommended procedure is to pressurize the Hose and check for leaks and to visually inspect the Hose for damage.
- Caution:** Matches, candles, open flame or other sources of ignition shall not be used for Hose inspection. Leak check solutions should be rinsed off after use.

F





**Alphanumeric Index**

Part Number	Page	Part Number	Page	Part Number	Page	Part Number	Page
<b>015301 -02Y6-16-9C</b>							
015301	E5	101HP-2-3	B116	15K0101-8-8C	C29	2243D-03V70	B20
015306	E5	101HP-2-4	B116	15K0201-1-8C	C29	2243D-04V70	B23
015307	E5	101HP-4-3	B116	15K0201-2-8C	C29	2244N-025V00	B26
015308	E5	101HP-4-4	B116	15K0201-4-8C	C29	2244N-08V10	B28
015309	E5	101HP-4-6	B116	15K0201-6-8C	C29	2244N-08V71	B28
015736	E5	101HP-6-3	B116	15K0202-2-2C	C27	2244N-20V30	B30
02Y5-2-4C	C12	101HP-6-4	B116	15K0202-4-4C	C27	2245D-03V32	B31
02Y5-2-6C	C12	101HP-6-6	B116	15K0202-6-6C	C27	2245N-04V00	B33, B118
02Y5-2-9C	C12	101HP-8-6	B116	15K0202-8-8C	C27	2245N-04V02	B33, B118
02Y5-2-12C	C12	101NX-4-4	B15, B23, B33	15KL02-4C	C27	2245N-04V04	B33, B118
02Y5-2-16C	C12		B55, B118,	15KL02-6C	C27	2245N-05V00	B37
02Y5-4-4C	C12	101NX-6-05	B37	15KL02-8C	C27	2245N-06V30	B39
02Y5-4-6C	C12	101NX-6-06	B39	15KT02-4C	C28	2245N-08V30	B41
02Y5-4-9C	C12	101NX-6-4	B15, B23, B33	15KT02-6C	C28	2245N-12V30	B43
02Y5-4-12C	C12		B55, B118	15KT02-8C	C28	2245N-16V30	B45
02Y5-4-16C	C12	101NX-6-5	B47	15KX02-4C	C28	2380F-05V07	B47
02Y5-6-4C	C12	101NX-8-06	B39	15KX02-6C	C28	2380F-08V07	B48
02Y5-6-6C	C12	101PX-4-4	B6	15KX02-8C	C28	2380F-12V07	B50
02Y5-6-9C	C12	101RS-8-08	B113	1925X-4-3	B94	2380N-04V00	B52, B121
02Y5-6-12C	C12	1068X-4-4	B53, B110,	1928X-4-4	B53, B61	2380N-04V02	B52, B121
02Y5-6-16C	C12		B122	192LX-4-3	B75	2380N-04V04	B52, B121
02Y5-8-4C	C12	1068X-6-4	B53, B110,	192NX-6-05	B38	2380N-04V33	B55
02Y5-8-6C	C12		B122	192NX-6-06	B40	2380N-04V71	B52
02Y5-8-9C	C12	1069X-12-12	B44, B51,	192NX-8-06	B40	2380N-05V00	B58
02Y5-8-12C	C12		B68	1AY8X-6-2A	B27	2380N-05V71	B58
02Y5-8-16C	C12	1069X-16-12	B44, B51,	1BCLX-4-4	B25	2390N-04V10	B60
02Y5-12-4C	C12		B68	1BCNX-4-4	B17, B35,	2390N-04V12	B60
02Y5-12-6C	C12	1069X-16-16	B46, B70		B57, B119	2390N-04V16	B60
02Y5-12-9C	C12	106EX-4-012	B3	1BCPX-4-4	B7	2390N-06V13	B63
02Y5-12-12C	C12	106HP-4-3	B116	1C38X-4-4	B54, B111,	2390N-08V12	B65
02Y5-12-16C	C12	106HP-4-4	B116		B124	2390N-08V13	B65
02Y5-16-6C	C12	106HP-5-4	B116	1C3NX-8-4	B35, B120	2390N-08V16	B65
02Y5-16-9C	C12	106HP-6-4	B116	1C3PX-8-4	B7	2390N-12V03	B67
02Y5-16-12C	C12	106HP-6-6	B116	1C9NX-12-05	B38	2390N-16V12	B69
02Y5-16-16C	C12	106NX-4-4	B7, B16, B24,	1C9NX-14-06	B40	2390N-16V13	B69
02Y6-2-4C	C22		B34, B56,	1C9RS-16-08	B113	2390N-16V16	B69
02Y6-2-6C	C22	106NX-6-4	B7, B16, B24	1D98X-4-4	B54, B62,	2440D-025V37	B71
02Y6-2-9C	C22		B34, B56		B111, B123	2440D-03V37	B73
02Y6-4-4C	C22		B118, B119	1D9LX-4-4	B25	2440D-05V37	B80
02Y6-4-6C	C22	106NX-6-05	B37, B47	1D9NX-4-4	B17, B35	2440N-04V37	B77
02Y6-4-9C	C22	106NX-6-06	B39	1D9NX-4-4	B57, B120	2440N-04V71	B77
02Y6-6-4C	C22	106NX-8-06	B39	1D9PX-4-4	B8	2440N-06V91	B82
02Y6-6-6C	C22	106NX-20-20	B30	1MB8X-6-4	B54, B111,	2440N-08V37	B83
02Y6-6-9C	C22	106PX-R-R	B7		B123	2440N-08V71	B83
02Y6-8-4C	C22	10K0101-12-12C	C29	1MBPX-6-4	B8	2440N-12V37	B85
02Y6-8-6C	C22	10K0101-16-16C	C29			2440N-12V71	B85
02Y6-8-9C	C22	10K0202-12-12C	C27	<b>201RX-2-2C -</b>		2440N-16V37	B87
02Y6-12-6C	C22	10K0202-16-16C	C27	<b>2X90N-06V04</b>		2440N-16V71	B87
02Y6-12-9C	C22	10KL02-12C	C27	201RX-2-2C	B4	2440N-32V10	B89
02Y6-16-9C	C22	10KL02-16C	C27	2020N-012V30	B3	2640D-025V32	B91
		10KT02-12C	C28	2020N-02V30	B4	2640D-03V32	B93
		10KT02-16C	C28	2040N-04V00	B6	2640N-08V32	B95
		10KX02-12C	C28	206RX-4-2C	B5	2640N-12V32	B97
		13BNX-6-05	B38	216-200-18	E2	2640N-12V71	B97
		13BNX-6-06	B40	220-200-22	E2	2640N-32V80	B99
		13BNX-8-06	B40	2240D-02V32	B9	2740D-025V30	B101
		15K0101-1-1C	C29	2240D-025V34	B10	2740D-03V30	B103
		15K0101-2-2C	C29	2240D-03V34	B13	2740D-05V32	B105
		15K0101-4-4C	C29	2240D-04V32	B15	2840D-03V34	B106
		15K0101-6-6C	C29	2240D-05V32	B18	2840D-05V32	B107
				2243D-025V70	B19	2840D-08V30	B108
						2TURX-4-2C	B5



**Alphanumeric Index**

Part Number	Page	Part Number	Page	Part Number	Page	Part Number	Page	
2X90N-04V14 .....	B109	5Y02-12-4C .....	C15	5YY6-4-6C .....	C10	601NX-4-4C .....	B6, B15,	
2X90N-06V14 .....	B112	5Y02-12-6C .....	C15	5YY6-4-9C .....	C10	... B23, B33, B55, B118		
2X90N-08V14 .....	B113	5Y02-12-8C .....	C15	5YY6-6-4C .....	C10	601PL-1-2 .....	B9	
<b>416-400-16 -5YY6-16-9C</b>								
416-40-16 .....	E3	5Y02-12-12C .....	C15	5YY6-6-6C .....	C10	601RS-6-6 .....	B112	
508-J-500-10 .....	E2	5Y02-12-16C .....	C15	5YY6-6-9C .....	C10	601VX-2-2A .....	B19	
510-A-500-12 .....	E2	5Y02-16-2C .....	C15	5YY6-9-4C .....	C10	602AX-1-2A .....	B11	
520-A-500-26 .....	E2	5Y02-16-4C .....	C15	5YY6-9-6C .....	C10	602AX-2-3 ...	B13, B21, B31	
57CR-6 .....	B114	5Y02-16-6C .....	C15	5YY6-9-9C .....	C10	602NX-4-4 .....	B16, B24,	
57CR-8 .....	B114	5Y02-16-8C .....	C15	5YY6-12-4C .....	C10	.....	B34, B56	
57CR-16 .....	B114	5Y02-16-12C .....	C15	5YY6-12-6C .....	C10	6068X-4-2AC .....	B27	
5Y01-4-2C .....	C11	5Y02-16-16C .....	C15	5YY6-12-9C .....	C10	6068X-8-8C .....	B29	
5Y01-4-4C .....	C11	5Y5Y-4-4C .....	C13	5YY6-16-4C .....	C10	6069X-4-4C .....	B53, B61,	
5Y01-4-6C .....	C11	5Y5Y-4-6C .....	C13	5YY6-16-6C .....	C10	.....	B110, B122	
5Y01-4-8C .....	C11	5Y5Y-4-9C .....	C13	5YY6-16-9C .....	C10	6069X-6-4C .....	B53, B61,	
5Y01-4-12C .....	C11	5Y5Y-4-12C .....	C13	<b>6015X-32-32C-TC -</b>				.....
5Y01-4-16C .....	C11	5Y5Y-4-16C .....	C13	<b>6ZEAX-5-2A</b>				6069X-8-6C .....
5Y01-6-2C .....	C11	5Y5Y-6-6C .....	C13	6015X-32-32C-TC .....	B99	6069X-8-8C .....	B42, B49,	
5Y01-6-4C .....	C11	5Y5Y-6-9C .....	C13	6018X-2-2A .....	B26	.....	B66	
5Y01-6-6C .....	C11	5Y5Y-6-12C .....	C13	6018X-2-2AC .....	B26	6069X-16-16C .....	B46, B70	
5Y01-6-8C .....	C11	5Y5Y-6-16C .....	C13	6018X-4-2AC .....	B26	606AX-4-2A .....	B11	
5Y01-6-12C .....	C11	5Y5Y-9-9C .....	C13	6018X-4-4 .....	B52, B60,	606AX-4-3C .....	B14, B22,	
5Y01-6-16C .....	C11	5Y5Y-9-12C .....	C13	.....	B109, B121	.....	B32	
5Y01-9-2C .....	C11	5Y5Y-9-16C .....	C13	6018X-8-8C .....	B28	606CR-6-6C .....	B114	
5Y01-9-4C .....	C11	5Y5Y-12-12C .....	C13	6019X-4-4C .....	B60	606CR-8-8C .....	B114	
5Y01-9-6C .....	C11	5Y5Y-12-16C .....	C13	6019X-6-6 .....	B63	606CR-16-16C .....	B114	
5Y01-9-8C .....	C11	5Y5Y-16-16C .....	C13	6019X-6-6C .....	B63	606LX-6-5C .....	B59	
5Y01-9-12C .....	C11	5Y6Y-4-4C .....	C14	6019X-8-6 .....	B63	606LX-8-5C .....	B59	
5Y01-9-16C .....	C11	5Y6Y-4-6C .....	C14	6019X-8-6C .....	B63	606LX-16-12C .....	B44, B51,	
5Y01-12-2C .....	C11	5Y6Y-4-9C .....	C14	6019X-8-8 .....	B41, B65	.....	B68, B86	
5Y01-12-4C .....	C11	5Y6Y-6-4C .....	C14	6019X-8-8C .....	B41, B48,	606LX-16-16C .....	B88	
5Y01-12-6C .....	C11	5Y6Y-6-6C .....	C14	.....	B65	606LX-32-32 .....	B89	
5Y01-12-8C .....	C11	5Y6Y-6-9C .....	C14	6019X-12-12 .....	B43, B67	606NX-4-4C .....	B7, B16,	
5Y01-12-12C .....	C11	5Y6Y-9-4C .....	C14	6019X-16-16C .....	B45, B69	... B24, B34, B56, B119		
5Y01-12-16C .....	C11	5Y6Y-9-6C .....	C14	601AX-1-2A .....	B10	606NX-6-4C .....	B7, B16	
5Y01-16-2C .....	C11	5Y6Y-9-9C .....	C14	601AX-2-2A .....	B10	... B24, B34, B56, B119		
5Y01-16-4C .....	C11	5Y6Y-12-4C .....	C14	601AX-2-3 ...	B13, B20, B31	612-400-14 .....	E2, E3	
5Y01-16-6C .....	C11	5Y6Y-12-6C .....	C14	601AX-6-5 .....	B18	620-100-18 .....	E2	
5Y01-16-8C .....	C11	5Y6Y-12-9C .....	C14	601EX-2-012 .....	B3	63ZAX-5-2A .....	B12	
5Y01-16-12C .....	C11	5Y6Y-16-4C .....	C14	601EX-2-2 .....	B4	63ZAX-5-3 ...	B14, B22, B32	
5Y01-16-16C .....	C11	5Y6Y-16-6C .....	C14	601EX-2-2 .....	B4	63ZAX-5-3C .....	B14, B22	
5Y02-4-2C .....	C15	5Y6Y-16-9C .....	C14	601EX-4-012 .....	B3	.....	B32	
5Y02-4-4C .....	C15	5YY5-4-6C .....	C9	601EX-2-2AC .....	B71	63ZNX-5-4C .....	B17, B25,	
5Y02-4-6C .....	C15	5YY5-4-9C .....	C9	601LX-2-4 .....	B77	.....	B36, B57	
5Y02-4-8C .....	C15	5YY5-4-12C .....	C9	601LX-4-3 ...	B13, B20, B73	65Y8X-6-4 .....	B53, B62	
5Y02-4-12C .....	C15	5YY5-4-16C .....	C9	601LX-4-4 .....	B77	65Y8X-6-4 .....	B110, B122	
5Y02-4-16C .....	C15	5YY5-6-4C .....	C9	601LX-4-4C .....	B52, B77,	65YLX-6-3 .....	B75	
5Y02-6-2C .....	C15	5YY5-6-9C .....	C9	.....	B109, B121	65YLX-6-4 .....	B79	
5Y02-6-4C .....	C15	5YY5-6-12C .....	C9	601LX-4-5 .....	B58	65YLX-6-4C .....	B53, B62,	
5Y02-6-6C .....	C15	5YY5-6-16C .....	C9	601LX-4-5C .....	B58, B80	.....	B79, B110, B122	
5Y02-6-8C .....	C15	5YY5-9-4C .....	C9	601LX-6-5 .....	B58, B80	66Y5X-4-3 .....	B94	
5Y02-6-12C .....	C15	5YY5-9-6C .....	C9	601LX-6-5C .....	B58, B80	66Y5X-4-3C .....	B94	
5Y02-6-16C .....	C15	5YY5-9-12C .....	C9	601LX-8-8 .....	B28, B3	66YHX-4-2AC ...	B92, B102	
5Y02-9-2C .....	C15	5YY5-9-16C .....	C9	601LX-8-8C .....	B83	66YHX-4-3C .....	B104	
5Y02-9-4C .....	C15	5YY5-12-4C .....	C9	601LX-12-12C .....	B67, B85	66YLX-4-3 .....	B74	
5Y02-9-6C .....	C15	5YY5-12-6C .....	C9	601LX-16-12C .....	B67, B85	66YLX-4-3C .....	B74	
5Y02-9-8C .....	C15	5YY5-12-9C .....	C9	601LX-16-16C .....	B87	6928X-4-4 .....	B110, B123	
5Y02-9-12C .....	C15	5YY5-12-16C .....	C9	601LX-16-16C .....	B87	692HX-4-3C .....	B104	
5Y02-9-16C .....	C15	5YY5-16-4C .....	C9	601LX-32-32 .....	B89	692LX-4-3C .....	B75	
5Y02-12-2C .....	C15	5YY5-16-6C .....	C9	601NX-2-4 ...	B15, B23, B33	692LX-4-4 .....	B78	
		5YY5-16-9C .....	C9	.....	B55	692LX-6-5C .....	B81	
		5YY5-16-12C .....	C9	601NX-4-4 ...	B15, B23, B33	6AY5X-6-3 .....	B93	
		5YY6-4-4C .....	C10	.....	B55	6AY5X-6-3C .....	B93	

**Alphanumeric Index**

Part Number	Page	Part Number	Page	Part Number	Page	Part Number	Page
6AY5X-11-8C .....	B95	6Y01-4-6C .....	C21	6Y6Y-6-6C .....	C23	AV6Y-6C-30 .....	C33
6AY5X-16-12C .....	B97	6Y01-4-8C .....	C21	6Y6Y-6-9C .....	C24	AV6Y-6C-60 .....	C35
6AY5X-16-12C-SD .....	B97	6Y01-4-12C .....	C21	6Y6Y-9-9C .....	C23	AV6Y-9C-30 .....	C33
6AY8X-6-2AC .....	B27	6Y01-4-16C .....	C21	6YALX-32-32 .....	B90	AV6Y-9C-60 .....	C35
6AY8X-6-4 .....	B52, B61	6Y01-6-2C .....	C21	6YHLX-4-2AC .....	B72	AY6C-CAP .....	C5
.....	B109, B122	6Y01-6-4C .....	C21	6YHLX-4-3C .....	B74	AY8C-CAP .....	C5
6AY8X-8-5C .....	B59	6Y01-6-6C .....	C21	6YHLX-6-3C .....	B74	AY11C-CAP .....	C5
6AY8X-11-8C .....	B29	6Y01-6-8C .....	C21	6YHLX-6-4C .....	B78	AY16C-CAP .....	C5
6AY9X-6-4C .....	B61	6Y01-6-12C .....	C21	6YY5-4-4C .....	C10	C09-125-1680 .....	D15
6AY9X-8-6C .....	B64	6Y01-6-16C .....	C21	6YY5-4-6C .....	C10	C10-115-1202 .....	D10
6AY9X-11-8C .....	B42, B49,	6Y01-9-2C .....	C21	6YY5-4-9C .....	C10	C10-115-1222 .....	D10
.....	B66	6Y01-9-4C .....	C21	6YY5-4-12C .....	C10	C10-115-1401 .....	D10
6AY9X-16-16C .....	B46, B70	6Y01-9-6C .....	C21	6YY5-4-16C .....	C10	C10-115-1402 .....	D10
6AYAX-6-2A .....	B11	6Y01-9-8C .....	C21	6YY5-6-4C .....	C10	C10-115-1404 .....	D10
6AYAX-6-3 .....	B14, B21, B32	6Y01-9-12C .....	C21	6YY5-6-6C .....	C10	C10-115-1422 .....	D10
6AYHX-6-2AC .....	B91, B101	6Y01-9-16C .....	C21	6YY5-6-9C .....	C10	C10-115-1452 .....	D10
6AYHX-6-3C .....	B103	6Y02-4-2C .....	C24	6YY5-6-12C .....	C10	C10-115-1454 .....	D10
6AYHX-8-5C .....	B105	6Y02-4-4C .....	C24	6YY5-6-16C .....	C10	C10-115-6202 .....	D11
6AYHX-10-5C .....	B105	6Y02-4-6C .....	C24	6YY5-9-4C .....	C10	C10-115-6204 .....	D11
6AYHX-13-5C .....	B105	6Y02-4-8C .....	C24	6YY5-9-6C .....	C10	C10-115-6401 .....	D11
6AYLX-6-2AC .....	B71	6Y02-4-12C .....	C24	6YY5-9-9C .....	C10	C10-115-6402 .....	D11
6AYLX-6-3 .....	B14, B21,	6Y02-4-16C .....	C24	6YY5-9-12C .....	C10	C10-115-6404 .....	D11
.....	B32, B73	6Y02-6-2C .....	C24	6YY5-9-16C .....	C10	C10-115-6452 .....	D11
6AYLX-6-3C .....	B73	6Y02-6-4C .....	C24	6YY6-4-6C .....	C21	C10-115-6454 .....	D11
6AYLX-6-4 .....	B78	6Y02-6-6C .....	C24	6YY6-4-9C .....	C21	C10-116-1202 .....	D12
6AYLX-6-4C .....	B52, B78	6Y02-6-8C .....	C24	6YY6-6-4C .....	C21	C10-116-1222 .....	D12
.....	B109, B122	6Y02-6-12C .....	C24	6YY6-6-9C .....	C21	C10-116-1402 .....	D12
6AYLX-6-4C-SD .....	B52, B78,	6Y02-6-16C .....	C24	6YY6-9-4C .....	C21	C10-116-1422 .....	D12
.....	B109, B122	6Y02-9-2C .....	C24	6YY6-9-6C .....	C21	C10-116-5202 .....	D13
6AYLX-8-5C .....	B80	6Y02-9-4C .....	C24	6ZEAX-5-2A .....	B12	C10-116-6202 .....	D13
6AYLX-8-6C .....	B82	6Y02-9-6C .....	C24			C10-116-6402 .....	D13
6AYLX-11-8C .....	B29, B84	6Y02-9-8C .....	C24			C10-125-1202 .....	D13
6AYLX-11-8C-SD .....	B29,	6Y02-9-12C .....	C24			C10-125-5202 .....	D14
.....	B84	6Y02-9-16C .....	C24			C10-125-6202 .....	D14
6AYLX-16-12C .....	B44, B51	6Y25X-9-8C .....	B96			C19-950-0029 .....	D15
.....	B68, B85	6Y25X-12-8C .....	B96			C19-950-0062 .....	D15
6AYLX-16-12C-SD .....	B85	6Y25X-16-12C .....	B98			C19-950-0064 .....	D15
6AYLX-16-16C .....	B88	6Y2LX-9-5C .....	B81			C19-950-1600 .....	D15
6AYLX-16-16C-SD .....	B88	6Y2LX-9-8C .....	B84			C19-950-1601 .....	D15
6AYLX-16-16-HCL .....	B88	6Y2LX-12-5C .....	B81			C19-950-1602 .....	D15
6AYLX-32-32-Flat .....	B90	6Y2LX-12-8C .....	B84			C19-950-1622 .....	D15
6AYNX-6-4 .....	B16, B24	6Y2LX-16-12C .....	B86			C19-950-1623 .....	D15
.....	B34, B56, B119	6Y4HX-4-2AC .....	B92, B101			C19-950-1680 .....	D15
6AYNX-6-4C .....	B6, B16,	6Y4HX-6-2AC .....	B92, B101			CV5Y-4C-20 .....	C32
... ..	B24, B34, B56, B119	6Y4HX-6-3C .....	B103			CV5Y-6C-20 .....	C32
6AYWX-10-5C .....	B107	6Y4HX-9-3C .....	B103			CV5Y-9C-20 .....	C32
6AYWX-13-5C .....	B107	6Y4HX-9-5C .....	B105			CV6Y-4C-60 .....	C36
6C95X-16-8C .....	B96	6Y4HX-9-5C-XLT .....	B105			CV6Y-6C-60 .....	C36
6C95X-25-12C .....	B98	6Y4LX-4-2AC .....	B72			CV6Y-9C-60 .....	C36
6C9LX-16-8C .....	B29, B84	6Y4LX-6-2AC .....	B72			E204UZD1 .....	B12
6C9LX-25-12C .....	B86	6Y4LX-6-3C .....	B74			E206JCC3 .....	B61
6C9RS-14-5 .....	B112	6Y4LX-9-3C .....	B74			E206JEC3 .....	B61
6EYLX-6-3C .....	B76	6Y4WX-16-08C .....	B108			E213JFC4 .....	B66
6EYLX-6-4C .....	B79	6Y4WX-6-3C .....	B106			E225JIC3 .....	B70
6EYLX-9-5C .....	B81	6Y4WX-9-3C .....	B106			E404UAC1 .....	B72
6EZAX-5-2A .....	B12	6Y4WX-9-5C .....	B107			E405UBA1 .....	B75
6HE5X-32-32-FLATTC		6Y4WX-9-5C-RCS .....	B107			E405UDA2 .....	B74
.....	B100	6Y45X-6-3C .....	B93			E408LCA2 .....	B81
6HN5X-32-32-TC .....	B100	6Y45X-9-3C .....	B93			E408LCA3 .....	B81
6HYPL-1-2 .....	B9	6Y6Y-4-4C .....	C23				
6Y01-4-2C .....	C21	6Y6Y-4-6C .....	C24				
6Y01-4-4C .....	C21	6Y6Y-4-9C .....	C24				



**80C-001-PFD – 94C-080-PFD**

80C-001-PFD .....	E5
80C-081-PFD .....	E5
80C-F08W .....	E4
80C-G03 .....	B117, E4
80C-G04 .....	B117, E4
80C-G06 .....	B117, E4
80C-HP3 .....	E4
80C-HP4 .....	B117, E4
80C-HP6 .....	B117
80C-R01-PFD .....	E5
80C-YP6 .....	E4
82C-R01-PFD .....	E5
82C-R02-PFD .....	E5
83C-081-PFD .....	E5
83C-9X04 .....	E4
83C-9X08 .....	E4
83C-9X16 .....	E4
83C-F16W .....	E4
94C-080-PFD .....	E5

**AV5Y-4C-20 –E408LCA3**

AV5Y-4C-20 .....	C31
AV5Y-6C-20 .....	C31
AV5Y-9C-20 .....	C31
AV5Y-12C-20 .....	C31
AV5Y-16C-20 .....	C31
AV6Y-4C-30 .....	C33
AV6Y-4C-60 .....	C35





**Alphanumeric Index**

Part Number	Page	Part Number	Page	Part Number	Page	Part Number	Page
Y209-1000C	C19	Y501-12-4C	C17	Y601-4-6C	C23	YA6C-PLUG	C5
Y209-1200C	C19	Y501-12-6C	C17	Y601-4-8C	C23	YA8C-PLUG	C5
Y212-0400C	C19	Y501-12-8C	C17	Y601-4-12C	C23	YA11C-PLUG	C5
Y212-0600C	C19	Y501-12-12C	C17	Y601-6-4C	C23	YA16C-PLUG	C5
Y212-0800C	C19	Y501-12-16C	C17	Y601-6-6C	C23	YAY1-8-16C	C5
Y212-1000C	C19	Y501-16-2C	C17	Y601-9-4C	C23	YAY1-11-16C	C5
Y212-1200C	C19	Y501-16-12C	C17	Y601-9-6C	C23	YAY1-16-16C	C5
Y216-0600C	C19	Y501-16-16C	C17	Y601-9-8C	C23	YAY2-8-16C	C5
Y216-0800C	C19	Y501-16-4C	C17	Y601-9-12C	C23	YAY2-11-16C	C5
Y216-1000C	C19	Y501-16-6C	C17	Y601-9-16C	C23	YAY2-16-16C	C5
Y216-1200C	C19	Y501-16-8C	C17	Y6Y6-4-4C	C22	YAY5-6-4C	C6
Y404-0275C	C26	Y5Y5-4-4C	C16	Y6Y6-4-6C	C22	YAY5-6-6C	C6
Y404-0300C	C26	Y5Y5-4-6C	C16	Y6Y6-4-9C	C22	YAY5-6-9C	C6
Y404-0400C	C26	Y5Y5-4-12C	C16	Y6Y6-6-6C	C22	YAY5-6-12C	C6
Y404-0600C	C26	Y5Y5-4-16C	C16	Y6Y6-6-9C	C22	YAY5-8-6C	C6
Y404-0800C	C26	Y5Y5-6-6C	C16	Y6Y6-9-9C	C22	YAY5-8-9C	C6
Y404-1000C	C26	Y5Y5-6-9C	C16	YA01-6-2C	C7	YAY5-8-12C	C6
Y404-1200C	C26	Y5Y5-6-12C	C16	YA01-6-4C	C7	YAY5-11-6C	C6
Y406-0300C	C26	Y5Y5-6-16C	C16	YA01-6-6C	C7	YAY5-11-9C	C6
Y406-0600C	C26	Y5Y5-9-9C	C16	YA01-6-8C	C7	YAY5-11-12C	C6
Y406-0800C	C26	Y5Y5-9-12C	C16	YA01-8-4C	C7	YAY5-16-9C	C6
Y406-1000C	C26	Y5Y5-9-16C	C16	YA01-8-6C	C7	YAY5-16-12C	C6
Y406-1200C	C26	Y5Y5-12-12C	C16	YA01-8-8C	C7	YAY6-6-4C	C4
Y409-0400C	C26	Y5Y5-12-16C	C16	YA01-8-12C	C7	YAY6-6-6C	C4
Y409-0600C	C26	Y5Y6-4-4C	C16	YA01-8-16C	C7	YAY6-6-9C	C4
Y409-0800C	C26	Y5Y6-4-6C	C16	YA01-11-6C	C7	YAY6-8-6C	C4
Y409-1000C	C26	Y5Y6-4-9C	C16	YA01-11-8C	C7	YAY6-8-9C	C4
Y409-1200C	C26	Y5Y6-6-4C	C16	YA01-11-12C	C7	YAY6-10-6C	C4
Y501-4-4C	C17	Y5Y6-6-9C	C16	YA01-11-16C	C7	YAY6-10-9C	C4
Y501-4-8C	C17	Y5Y6-9-4C	C16	YA01-16-12C	C7	YAY6-11-9C	C4
Y501-6-4C	C17	Y5Y6-9-9C	C16	YA01-16-8C	C7	YAYA-6-6C	C4
Y501-6-6C	C17	Y5Y6-12-4C	C16	YA01-16-16C	C7	YAYA-8-6C	C4
Y501-6-8C	C17	Y5Y6-12-6C	C16	YA01-16-20C	C7	YAYA-8-8C	C4
Y501-9-2C	C17	Y5Y6-12-9C	C16	YA01-16-24C	C7	YAYA-10-6C	C4
Y501-9-4C	C17	Y5Y6-16-4C	C16	YA01-16-32C	C7	YAYA-10-10C	C4
Y501-9-6C	C17	Y5Y6-16-6C	C16	YA02-6-4C	C6	YAYA-11-8C	C4
Y501-9-8C	C17	Y5Y6-16-9C	C16	YA02-6-8C	C6	YAYA-11-11C	C4
Y501-9-12C	C17	Y601-4-2C	C23	YA02-8-8C	C6	YAYA-16-11C	C4
Y501-9-16C	C17	Y601-4-4C	C23	YA02-11-8C	C6	YAYA-16-16C	C4
Y501-12-2C	C17						







## Offer of Sale

The items described in this document are hereby offered for sale at prices to be established by Parker Hannifin Corporation, its subsidiaries and its authorized distributors. This offer and its acceptance by any customer ("Buyer") shall be governed by all of the following Terms and Conditions. Buyer's order for any item described in this document, when communicated to Parker Hannifin Corporation, its subsidiary or an authorized distributor ("Seller") verbally or in writing, shall constitute acceptance of this offer.

- 1. Terms and Conditions of Sale:** All descriptions, quotations, proposals, offers, acknowledgments, acceptances and sales of Seller's products are subject to and shall be governed exclusively by the terms and conditions. Any terms or conditions in addition to, or inconsistent with those stated herein, proposed by Buyer in any acceptance of an offer by Seller, are hereby objected to. No such additional, different or inconsistent terms and conditions shall become part of the contract between Buyer and Seller unless expressly accepted in writing by Seller. Seller's acceptance of any offer to purchase by Buyer is expressly conditional upon Buyer's assent to all the terms and conditions stated herein, including any terms in addition to, or inconsistent with those contained in Buyer's offer. Acceptance of Seller's products shall in all events constitute assent.
- 2. Payment:** Payment shall be made by Buyer net 30 days from the date of delivery of the items purchased hereunder. Amounts not timely paid shall bear interest at the rate of 1-1/2% for each month or a portion thereof that Buyer is late in making payment. Any claims by Buyer for omissions or shortages in a shipment shall be waived unless Seller receives notice thereof within 30 days after Buyer's receipt of the shipment.
- 3. Delivery:** Unless otherwise provided on the face hereof, delivery shall be made F.O.B. Seller's plant. Regardless of the method of delivery, however, risk of loss shall pass to Buyer upon Seller's delivery to a carrier. Any delivery dates shown are approximate only and Seller shall have no liability for delays in delivery.
- 4. Warranty:** Seller warrants that the items sold hereunder shall be free from defects in materials or workmanship for a period of 365 days from the date of shipment to Buyer, or 2,000 hours of use, whichever expires first. **THIS WARRANTY COMPRISES THE SOLE AND ENTIRE WARRANTY PERTAINING TO ITEMS PROVIDED HEREUNDER. SELLER MAKES NO OTHER WARRANTY, GUARANTEE, OR REPRESENTATIONS OF ANY KIND WHATSOEVER. ALL OTHER WARRANTIES, INCLUDING BUT NOT LIMITED TO, MERCHANTABILITY AND FITNESS FOR PURPOSE, WHETHER EXPRESS, IMPLIED, OR ARISING BY OPERATION OF LAW, TRADE USAGE, OR COURSE OF DEALING ARE HEREBY DISCLAIMED.**  
**NOTWITHSTANDING THE FOREGOING, THERE ARE NO WARRANTIES WHATSOEVER ON ITEMS BUILT OR ACQUIRED WHOLLY OR PARTIALLY, TO BUYER'S DESIGNS OR SPECIFICATIONS.**
- 5. Limitation Of Remedy: SELLER'S LIABILITY ARISING FROM OR IN ANY WAY CONNECTED WITH THE ITEMS SOLD OR THIS CONTRACT SHALL BE LIMITED EXCLUSIVELY TO REPAIR OR REPLACEMENT OF THE ITEMS SOLD, OR REFUND OF THE PURCHASE PRICE PAID BY BUYER, AT SELLER'S SOLE OPTION. IN NO EVENT SHALL SELLER BE LIABLE FOR ANY INCIDENTAL, CONSEQUENTIAL OR SPECIAL DAMAGES OF ANY KIND OR NATURE WHATSOEVER, INCLUDING BUT NOT LIMITED TO LOST PROFITS ARISING FROM OR IN ANY WAY CONNECTED WITH THIS AGREEMENT OR ITEMS SOLD HEREUNDER, WHETHER ALLEGED TO ARISE FROM BREACH OF CONTRACT, EXPRESS OR IMPLIED WARRANTY, OR IN TORT, INCLUDING WITHOUT LIMITATION, NEGLIGENCE, FAILURE TO WARN OR STRICT LIABILITY.**
- 6. Changes, Reschedules and Cancellations:** Buyer may request to modify the designs or specifications for the item sold hereunder as well as the quantities and delivery dates thereof, or may request to cancel all or part of this order, however, no such requested modification or cancellation shall become part of the contract between Buyer and Seller unless accepted by Seller in a written amendment to this Agreement. Acceptance of any such requested modification of cancellation shall be at Seller's discretion, and shall be upon such terms and conditions as Seller may require.
- 7. Special Tooling:** A tooling charge may be imposed for any special tooling, including without limitation, dies, fixtures, molds and patterns, acquired to manufacture items sold pursuant to this contract. Such special tooling shall be and remain Seller's property notwithstanding payment of any charges therefor by Buyer. In no event will Buyer acquire any interest in apparatus belonging to Seller which is utilized in the manufacture of the items sold hereunder, even if such apparatus has been specially converted or adapted for such manufacture and notwithstanding any charges paid by Buyer therefor. Unless otherwise agreed, Seller shall have the right to alter, discard or otherwise dispose of any special tooling or other property in its sole discretion at any time.
- 8. Buyer's Property:** Any designs, tools, patterns, materials, drawings, confidential information or equipment furnished by Buyer, or any other items which become Buyer's property, may be considered obsolete and may be destroyed by Seller after two (2) consecutive years have elapsed without Buyer placing an order for the items which are manufactured using such property. Seller shall not be responsible for any loss or damage to such property while it is in Seller's possession or control.
- 9. Taxes:** Unless otherwise indicated on the face hereof, all prices and charges are exclusive of excise, sales, use, property, occupational or like taxes which may be imposed by any taxing authority upon the manufacture, sale or delivery of the items sold hereunder. If any such taxes must be paid by Seller, or if Seller is liable for the collection of such tax, the amount thereof shall be in addition to the amounts for the items sold. Buyer agrees to pay all such taxes or to reimburse Seller therefor upon receipt of its invoice. If Buyer claims exemption from any sales, use or other tax imposed by any taxing authority, Buyer shall save Seller harmless from and against any such tax, together with any interest or penalties thereon which may be assessed if the items are held to be taxable.
- 10. Indemnity For Infringement of Intellectual Property Rights:** Seller shall have no liability for infringement of any patents, trademarks, copyrights, trade dress, trade secrets or similar rights except as provided in this Part 10. Seller will defend and indemnify Buyer against allegations of infringement of U.S. patents, U.S. trademarks, copyrights, trade dress and trade secrets (hereinafter 'Intellectual Property Rights'). Seller will defend at its expense and will pay the cost of any settlement or damages awarded in an action brought against Buyer based on an allegation that an item sold pursuant to this contract infringes the Intellectual Property Rights of a third party. Seller's obligation to defend and indemnify Buyer is contingent on Buyer notifying Seller within ten (10) days after Buyer becomes aware of such allegations of infringement, and Seller having sole control over the defense of any allegations or actions, including all negotiations for settlement or compromise. If an item sold hereunder is subject to a claim that it infringes the Intellectual Property Rights of a third party, Seller may, at its sole expense and option, procure for Buyer the right to continue using said item, replace or modify said item so as to make it noninfringing, or offer to accept return of said item and return the purchase price less a reasonable allowance for depreciation.  
  
Notwithstanding the foregoing, Seller shall have no liability for claims of infringement based on information provided by Buyer, or directed to items delivered hereunder for which the designs are specified in whole or part by Buyer, or infringements resulting from the modification, combination or use in a system of any item sold hereunder. The foregoing provisions of this Part 10 shall constitute Seller's sole and exclusive liability and Buyer's sole and exclusive remedy for infringement of Intellectual Property Rights.  
  
If a claim is based on information provided by Buyer or if the design for an item delivered hereunder is specified in whole or in part by Buyer, Buyer shall defend and indemnify Seller for all costs, expenses or judgements resulting from any claim that such an item infringes any patent, trademark, copyright, trade dress, trade secret or any similar right.
- 11. Force Majeure:** Seller does not assume the risk of and shall not be liable for delay or failure to perform any of Seller's obligations by reason of circumstances beyond the reasonable control of Seller (hereinafter 'Events of Force Majeure'). Events of Force Majeure shall include without limitation, accidents, acts of God, strikes or labor disputes, acts, laws, rules or regulations of any government or government agency, fires, floods, delays or failures in delivery of carriers or suppliers, shortages of materials and any other cause beyond Seller's control.
- 12. Entire Agreement/Governing Law:** The terms and conditions set forth herein, together with any amendments, modifications and any different terms or conditions expressly accepted by Seller in writing, shall constitute the entire Agreement concerning the items sold, and there are no oral or other representations or agreements which pertain thereto. This Agreement shall be governed in all respects by the law of the State of Ohio. No actions arising out of the sale of the items sold hereunder or this Agreement may be brought by either party more than two (2) years after the cause of action accrues.

# Fluid Connectors Group Regional Sales Offices & Service Centers

**Your complete source** for quality tube fittings, hose & hose fittings, brass fittings & valves, quick-disconnect couplings, and assembly tools, locally-available from a worldwide network of authorized distributors.

**Fittings & Couplings:** Available in inch and metric sizes covering SAE, BSP, DIN, GAZ, JIS and ISO thread configurations, manufactured from steel, stainless steel, brass, aluminum, nylon and thermoplastic.

**Hose, Tubing and Bundles:** Available in a wide variety of sizes and materials including rubber, wire-reinforced thermoplastic, hybrid and custom compounds.

**Worldwide Availability:** Parker operates Fluid Connectors manufacturing locations and sales offices throughout North America, South America, Europe and Asia-Pacific.

For information, contact the nearest Regional Sales Office listed, or **call toll-free 1-800-C-PARKER** (1-800-272-7537).

**Central Region  
Sales Office & Service Center**  
Hiawatha, IA  
(319) 393-1221  
(319) 393-1224 FAX

**Cleveland Region  
Sales Office**  
Cleveland, OH  
(216) 896-3000  
(216) 896-4022 FAX  
**Service Center**  
Toledo, OH  
(419) 878-7000  
(419) 878-7001 FAX

**Great Lakes Region  
Sales Office & Service Center**  
Otsego, MI  
(269) 694-2550  
(269) 692-6634 FAX  
**Service Center**  
Toledo, OH  
(419) 878-7000  
(419) 878-7001 FAX  
**Service Center**  
Ft. Wayne, IN  
(260) 747-3111  
(260) 747-3026 FAX

**Minneapolis Region  
Sales Office & Service Center**  
Minneapolis, MN  
(952) 469-5000  
(952) 469-5729 FAX  
**Service Center**  
(920) 426-8471  
(920) 426-8570 FAX

**Northeast Region  
Sales Office & Service Center**  
Trenton, NJ  
(609) 586-5151  
(609) 586-3149 FAX

**Pacific Region  
Sales Office & Service Center**  
Portland, OR  
(503) 283-1020  
(503) 283-2201 FAX  
**Service Center**  
Buena Park, CA  
(714) 522-8840  
(714) 994-1183 FAX

**Southeast Region  
Sales Office & Service Center**  
Greensboro, NC  
(336) 373-1761  
(336) 378-0913 FAX  
**Service Center**  
Conyers, GA  
(770) 929-0330  
(770) 929-0230 FAX

**Southwest Region  
Sales Office & Service Center**  
Mansfield, TX  
(817) 473-4431  
(817) 473-8078 FAX

**Canada  
Sales Office & Service Center**  
Grimsby, ON  
(905) 945-2274  
(905) 945-3946 FAX  
*(Contact Grimsby for other Service Center locations.)*



**Parker Hannifin Corporation**  
Parflex Division Polyflex Operation  
12840 Sugar Ridge Blvd.  
Stafford, TX 77477  
Tel: (281) 530-5300  
Fax: (281) 530-5353  
www.polyflexusa.com



Catalog 4900, 6/03, PL