

aerospace
climate control
electromechanical
filtration
fluid & gas handling
hydraulics
pneumatics
process control
sealing & shielding



Thermoplastic Hoses for the Oil and Gas Industry

Oil & Gas Catalogue 4465 –
Global Edition 2010



ENGINEERING YOUR SUCCESS.

Thermoplastic Hoses for the Oil and Gas Industry Facilities



Hüttenfeld / Germany



Wissembourg / France



Almelo / Netherlands



Ravenna / Ohio



Stafford / Texas

For Your Safety

The hose assemblies listed in this catalogue are all special constructions with the hose having up to eight spiral layers of steel wire. Due to this construction, pressures are achieved which far exceed German and international standards. These hose types are manufactured and tested according to the Polyflex standards which have proved to be effective over many years.

Polyflex hose assemblies are used at considerable working pressures. The critical area of a hose assembly is the connection between flexible hose and rigid fitting (crimping area). Only the use of original Polyflex components (hose, fittings and tooling) and full compliance with the Polyflex assembly instructions can guarantee safety and conformity with standards. It is essential that training be given to customers in the hose assembly process in order to make high quality Polyflex maximum pressure hose assemblies.

For the production and testing of the hose assemblies relevant to the applications, the guidelines and technical regulations as well as the protection and hazard prevention rulings must be adhered to.

You as the manufacturer of Polyflex hose assemblies are obliged to mark these hose assemblies according to the regulations and to verify their safety by a final pressure test.

Non-compliance with these rules can lead to the premature failure of the hose assembly and the loss of warranty.

- A** - *General Information*
- B** - *Umbilical and jumper hoses*
- C** - *BOP and hot-line hoses*
- D** - *High pressure hydraulic control and testing*
- E** - *Large bore hoses for use in well services*
- F** - *Hose umbilicals*
- G** - *High pressure connectors, adaptors and valves*
- H** - *Quick couplers*
- I** - *Accessories and tooling*
- J** - *Technical information*
- K** - *Index of part numbers*

Introduction

The Parflex and Polyflex divisions of Parker Hannifin have been supplying a wide range of thermoplastic hose products to the oil and gas market for over 30 years.

With sizes ranging from 2 mm to 2" and working pressures from 6 bar to 60,000 psi they offer the widest range of thermoplastic hoses available.

With production plants in both the USA and Europe supported by Parker's global sales and distribution network, customers can benefit from local service and the supply of quality parts wherever they are situated.

This catalogue concentrates on the thermoplastic hoses and associated products such as umbilicals, adapters and couplings. For more information about Parker's other oil and gas products, such as marine transfer hoses and tube umbilicals contact your nearest Parker sales office.

The Energy Products Division is the newest global division within the Fluid Connectors Group to focus on emerging market platforms; providing technical solutions in a wide variety of markets worldwide.

Specific products include:

- Subsea umbilical/cable manufacturing; service/installation
- Scanrope - Long term steel mooring line & fiber ropes
- Multitube - Instrument & Heat Trace Tubing and Bundles
- Polyflex Ultra High Pressure Thermoplastic Hose & Fittings
- Marine Hoses (Parker ITR S.r.l. - Business Unit Oil & Gas)
- Maritime - position monitoring / surveying systems & service
- Hydraulic Hose & Fittings – Tooling & Equipment – Hose Accessories

Applications include but are not limited to: Oil & Gas (Drilling, refining, mooring, transfer & surveying), renewable energy, waterblast, waterjet cutting, surface prep, "water as a tool", rescue tool, high pressure hydraulics, high pressure testing, veterinary, and environmental monitoring system.

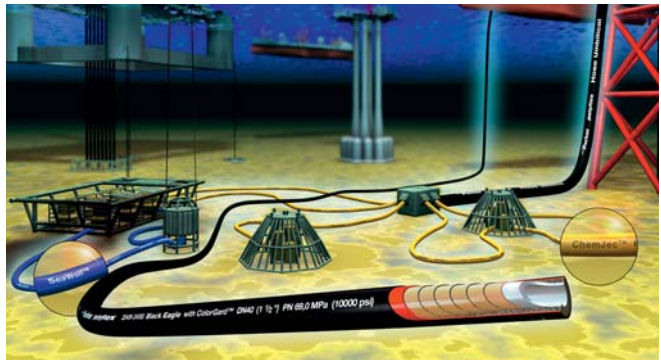

Chapter A**General Information**



Hose fitting chart.....	A-2
Pressure and I.D. selection of hose	A-4
Hose part numbering system.....	A-6
Hose end fitting part numbering system.....	A-6
Explanation of symbols.....	A-7
Easy navigation	A-8

SAFETY NOTE The working pressure of the hose assembly is the lower one from hose and fitting.

Hose fitting chart

Fitting	Fitting description	Fitting designation
	National Pipe Tapered (NPT) Male Fitting	01
	JIC Female Swivel Fitting	06
	Type "M" Female Swivel Fitting	AY
	BSP Female Swivel Fitting	BC or 92
	Metric Female Swivel Fitting	C3
	Metric Female Swivel Fitting with O-ring	C9

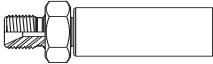
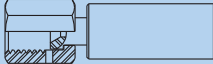
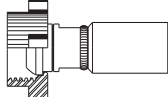
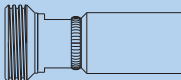
Hose fitting chart

Fitting	Fitting description	Fitting designation
	BSP Male Fitting	D9 or 3B
	Medium Pressure Female Swivel	5Y
	Hammer Union (Male) Cone with Wing Nut End Fitting	HE
	Hammer Union (Female) Cone Threaded End with Seal	HN
	Medium Pressure Tube Nipple	Y2

Pressure and I.D. selection of hose (working pressure in psi/MPa)

Dimensions Hose type	inch	1/8	3/16	1/4	5/16	3/8
	mm	3.2	4.8	6.4	7.9	9.5
	size	-02	-03	-04	-05	-06
	DN	3	5	6	8	10
Umbilical and Jumper hoses – Textile reinforced						
2022N-5K				5,000/34.5		5,000/34.5
2022N-10K				10,000/69.0		10,000/69.0
57CR						
Umbilical and Jumper hoses – Wire reinforced – Nylon 11						
2240N				6,250/43.0		
2340N				10,000/69.0		
2370N						6,250/43.0
2380N				10,000/69.0		7,500/51.7
2390N						6,450/44.5
2440N				12,500/86.5		12,500/86.5
2448N				15,000/103.5		15,000/103.5
2640N						
Umbilical and Jumper hoses – Wire reinforced – ChemJec						
2240M				6,250/43.0		
2340M				10,000/69.0		
2370M						6,250/43.0
2380M				10,000/69.0	8,700/60.0	
2390M						
2440M				12,500/86.5	10,000/69.0	10,000/69.0
2448M				15,000/103.5	15,000/103.5	15,000/103.5
2640M						
BOP and hotline hoses – Textile reinforced						
573LH			3,000/20.7			
575LH			5,000/34.5			
575X						
H580N						
BOP and hotline hoses – wire reinforced						
2390N						
Hydraulic control and testing – Textile reinforced						
2020N		5,800/40.0				
575X				5,000/34.5		5,000/34.5
520N			5,000/34.5	5,000/34.5	4,500/31.0	4,000/27.5
HP/HP8			10,000/69.0	10,000/69.0		10,000/69.0*
Hydraulic control and testing – Wire reinforced						
2380N				10,150/70.0	9,100/62.5	8,340/57.5
2440N				20,300/140.0*		20,300/140.0*
Large bore for well servicing						
2440N						
2448N						
2640N						
2580N						
2448M						
2640M						
2580M						

Notes: * safety factor less than 4:1
 product under development

	1/2	3/4	1	1 1/4	1 1/2	2	3	Page
	12.7	19	25.4	31.8	38.1	50.8	76.0	
	-08	-12	-16	-20	-24	-32	-48	
	12	20	25	32	40	50	78	
2022N-5K	5,000/34.5							B-2
2022N-10K	10,000/69.0							B-2
57CR	5,000/34.5		5,000/34.5					B-6
2240N								B-8
2340N								B-11
2370N								B-14
2380N	7,500/51.7			4,000/27.5				B-17
2390N	6,015/41.5	5,075/35.0	4,060/28.0					B-20
2440N	11,750/81.0	9,135/63.0	8,120/56.0					B-23
2448N								B-27
2640N	15,000/103.5	12,500/86.5	10,900/75.0					B-29
2240M								B-32
2340M								B-35
2370M								B-38
2390M								B-41
2390M		5,000/34.5	4,060/28.0					B-45
2440M	10,000/69.0	9,135/63.0	8,120/56.0					B-48
2448M								B-50
2640M	15,000/103.5							B-52
573LH								C-2
575LH								C-2
575X			5,000/34.5					C-2
H580N			3,000/20.7					C-2
2390N	9,570/66.0		6,530/45.0					C-4
2020N								D-2
575X	5,000/34.5	5,000/34.5	5,000/34.5					D-4
520N	3,500/24.0							D-7
HP/HP8								D-10
2380N	7,500/51.7							D-13
2440N	18,850/130.0*	14,500/100.0*	13,050/90.0*					D-16
2440N			7,500/51.7		5,000/34.5			E-5
2448N						5,000/34.5		E-5
2640N			15,000/103.5*		10,000/69.0*		10,000/69.0*	E-8
2580N						10,000/69.0*		E-8
2640M			10,000/69.0*		10,000/69.0*			E-11
2580M						10,000/69.0*		E-11

Hose part numbering system



2440 N - 16 V37

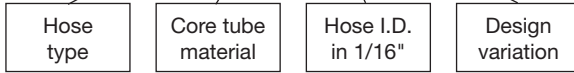



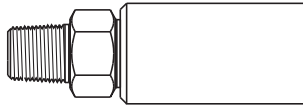





Hose end fitting part numbering system



6 01 LX - 8 - 8 C



Explanation of symbols

Symbol	Description
#	Part number
	Nominal inner diameter
	Nominal outer diameter
	Working pressure
	Burst pressure
	Bend radius
	Weight
	Fittings
	Thread size
	Wrench size
	Thickness

Easy navigation

For your convenience there are several types of guides to make navigation through the catalogue easy. Use those who are best suited for your purpose.

Tabs

Chapter tabs:

Located on top of each page, these tabs refer to chapters A to K:



Group tabs:

Located at the side of each page, these tabs designate the different product groups or themes:

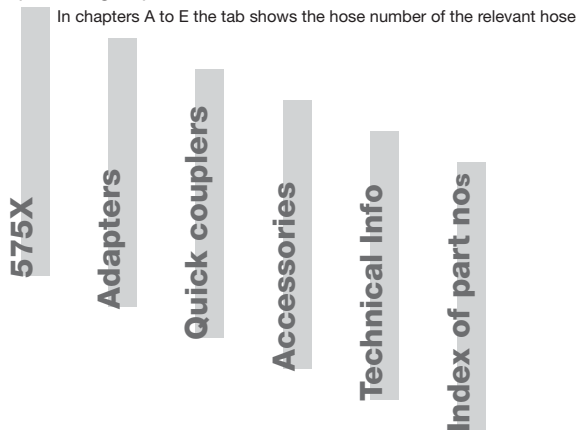

Colours

Tables and headers use two different colours:

In chapters A to E **hose tables** are shown in blue. Each individual hose type is directly followed by the related **fitting tables**, which are shown in yellow colour.

Symbols

For the meaning of the symbols which appear in table headers please refer to the previous page.

Table of contents

The general table of contents on the first catalogue page refers to the different chapters, and each chapter starts with a table of contents referring to the contained sections.

Index of part numbers

If you are searching for a special product by its part number, please use the alphanumeric index in chapter K.

Chapter B

Umbilical and jumper hoses

Textile reinforced hoses and related fittings	B-2
2022N – High pressure hose	B-2
“Sea Wolf” hoses and related fittings.....	B-7
57CRN – High collapse resistant hose	B-7
Wire spiral reinforced hoses and related fittings	B-9
V91 hoses with Nylon 11methanol washed core tube	
2240N (V91) – polyflex® hose.....	B-9
2340N (V91) – polyflex® hose.....	B-12
2370N (V91) – polyflex® hose.....	B-15
2380N (V91) – polyflex® hose.....	B-18
2390N (V91) – polyflex® hose.....	B-21
2440N (V91) – polyflex® hose.....	B-24
2448N (V91) – polyflex® hose.....	B-28
2640N (V91) – polyflex® hose.....	B-30
Chemjec hoses with fluoropolymer co-extruded core tube	
2240M (V30) – polyflex® hose ChemJec.....	B-33
2340M (V30) – polyflex® hose ChemJec.....	B-36
2370M (V30) – polyflex® hose ChemJec.....	B-39
2380M (V30) – polyflex® hose ChemJec.....	B-42
2390M (V30) – polyflex® hose ChemJec.....	B-46
2440M (V30) – polyflex® hose ChemJec.....	B-49
2448M (V30) – polyflex® hose ChemJec.....	B-51
2640M (V30) – polyflex® hose ChemJec.....	B-53

2022N – High pressure hose



MAIN FEATURES

- Strength of Aramid reinforcement with low weight, flexibility with excellent pressure capabilities
- Smooth bore for improved flow rate and low pressure drop
- ISO 13628-5 “Specification for Subsea Production Control Umbilicals”, Section 7.9 Hose construction

APPLICATIONS

- Long length hose and hose umbilicals requiring lightweight construction. High pressure hydraulics, pneumatics and lubricating oils, high pressure tools, jacks, test apparatus, oilfield pressure control devices and offshore oil applications.

CONSTRUCTION

Core tube : Polyamide 11, methanol washed
Pressure reinforcement : High tensile aramid fibre braids

Cover : Polyurethane, pin-pricked on request
Colour : Black

TEMPERATURE RANGE

-40°C up to +55°C
-40°F up to +131°F

#								
	size DN	inch mm	inch mm	psi MPa	psi MPa	inch mm	lbs/ft kg/m	
2022N-04V91-5K	-04	1/4	0.50	5,000	20,000	2.01	0.08	55
	6	6.4	12.7	34.5	138.0	51	0.12	
2022N-04V91-10K	-04	1/4	0.54	10,000	40,000	3.94	0.09	8X
	6	6.4	13.8	69.0	276.0	100	0.14	
2022N-06V91-5K	-06	3/8	0.63	5,000	20,000	3.00	0.10	55
	10	9.7	16.1	34.5	138.0	76	0.15	
2022N-06V91-10K	-06	3/8	0.70	10,000	40,000	3.94	0.16	3X
	10	9.8	17.9	69.0	276.0	100	0.24	
2022N-08V91-5K	-08	1/2	0.90	5,000	20,000	3.00	0.13	55
	12	12.9	22.9	34.5	138.0	76	0.17	
2022N-08V91-10K	-08	1/2	0.91	10,000	40,000	3.94	0.23	LX
	12	12.9	23.1	69.0	276.0	100	0.34	

NOTES Additional technical information in chapter “J”.

10655 – JIC female swivel fitting

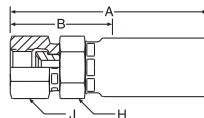

MATERIAL Stainless steel (AISI 316), other materials on request.

#	⊙			A	B	H	J	
	size DN	inch mm						
10655-4-4C	-04	1/4	7/16 - 20UNF	2.56	1.30	0.67	0.67	5,000
	6	6.4		65.0	33.0	17	17	34.5
10655-6-6C	-06	3/8	9/16 - 18UNF	2.72	1.30	0.75	0.75	5,000
	10	9.5		69.0	33.0	19	19	34.5
10655-8-8C	-08	1/2	3/4 - 16UNF	3.11	1.54	0.87	0.87	5,000
	12	12.7		79.0	38.0	22	22	34.5

2022N

1068X/1063X/106LX – JIC female swivel fitting

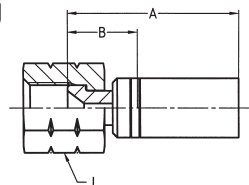

MATERIAL Stainless steel (AISI 316), other materials on request.

#	⊙			A	B	J	
	size DN	inch mm					
1068X-6-04C	-04	1/4	9/16 - 18UNF	2.17	0.94	0.75	10,000
	6	6.4		55.0	24.0	19	69.0
1063X-6-06C	-06	3/8	9/16 - 18UNF	2.72	1.30	0.87	10,000
	10	9.5		69.0	33.0	22	69.0
106LX-8-08C	-08	1/2	3/4 - 16UNF	2.52	0.83	1.06	10,000
	12	12.7		64.0	21.0	27	69.0

19255 – BSP female swivel fitting

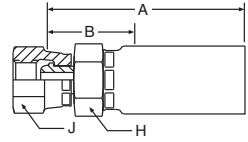

MATERIAL Stainless steel (AISI 316), other materials on request.

#	⊙		⌚	A	B	H	J	↻
	size DN	inch mm						
19255-4-4C	-04	1/4	G 1/4	2.28	1.02	0.67	0.75	5,000
	6	6.4		58.0	26.0	17	19	34.5
19255-6-6C	-06	3/8	G 3/8	2.52	1.06	0.75	0.87	5,000
	10	9.5		64.0	27.0	19	22	34.5
19255-8-8C	-08	1/2	G 1/2	2.87	1.26	0.94	1.06	5,000
	12	12.7		73.0	32.0	24	27	34.5

1928X/1923X – BSP female swivel fitting

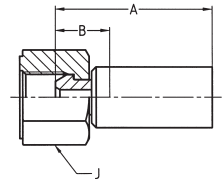

MATERIAL Stainless steel (AISI 316), other materials on request.

#	⊙		⌚	A	B	J	↻
	size DN	inch mm					
1928X-4-04C	-04	1/4	G 1/4	2.20	0.98	0.75	10,000
	6	6.4		56.0	25.0	19	69.0
1923X-8-06C	-06	3/8	G 1/2	2.60	0.87	1.18	10,000
	10	9.5		66.0	22.0	30	69.0
192LX-8-08C	-08	1/2	G 1/2	2.99	0.87	1.18	10,000
	12	12.7		76.0	22.0	30	69.0

1C955 – Metric swivel with O-Ring Heavy series

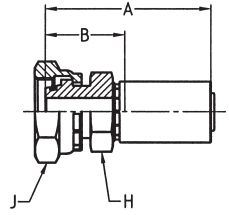

MATERIAL Stainless steel (AISI 316), other materials on request.

#	⊙		⌚	A	B	H	J	↻
	size DN	inch mm						
1C955-8-4C	-04	1/4	M16x1.5	2.76	1.50	0.67	0.75	5,000
	6	6.4		70.0	38.0	17	19	34.5
1C955-10-4C	-04	1/4	M18x1.5	2.64	1.42	0.75	0.87	5,000
	6	6.4		67.0	36.0	19	22	34.5
1C955-12-4C	-04	1/4	M20x1.5	2.52	1.26	0.75	0.94	5,000
	6	6.4		64.0	32.0	19	24	34.5
1C955-12-6C	-06	3/8	M20x1.5	2.68	1.26	0.75	0.94	5,000
	10	9.5		68.0	32.0	19	24	34.5
1C955-16-8C	-08	1/2	M24x1.5	3.03	1.42	0.94	1.18	5,000
	12	12.7		77.0	36.0	24	30	34.5

1C98X/1C93X/1C9LX – Metric swivel nut with O-ring Heavy series

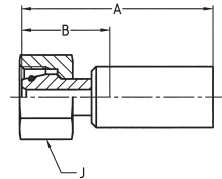

MATERIAL Stainless steel (AISI 316), other materials on request.

#	⊙		⌚	A	B	J	↻
	size DN	inch mm					
1C98X-8-04C	-04	1/4	M16 x 1.5	2.32	1.06	0.75	10,000
	6	6.4		59.0	27.0	19	69.0
1C98X-10-04C	-04	1/4	M18 x 1.5	2.56	1.30	0.87	10,000
	6	6.4		65.0	33.0	22	69.0
1C93X-14-06C	-06	3/8	M22 x 1.5	2.95	1.18	1.18	10,000
	10	9.5		75.0	30.0	30	69.0
1C93X-16-06C	-06	3/8	M24 x 1.5	3.46	1.34	1.18	10,000
	10	9.5		88.0	34.0	30	69.0
1C9LX-16-08C	-08	1/2	M24 x 1.5	3.46	1.34	1.18	10,000
	12	12.7		88.0	34.0	30	69.0

1AY8X – 59° sealing cone UNF swivel nut

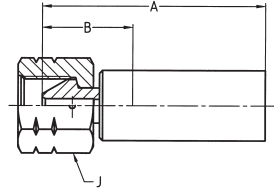

MATERIAL Stainless steel (AISI 316), other materials on request.

#	⊙		⌚	A	B	J	↗
	size DN	inch mm		inch mm	inch mm	inch mm	
1AY8X-6-04C	-04	1/4	9/16 - 18UNF	2.68	1.38	0.67	10,000
	6	6.4		68.0	35.0	17	

57CRN – High collapse resistant hose “Sea Wolf”



MAIN FEATURES

- Weather and ultra-high abrasion resistant. The hose is suitable for marine (salt water) environment
- Smooth bore for improved flow rate and low pressure drop
- ISO 13628-5 “Specification for Subsea Production Control Umbilicals”, Section 7.9 Hose construction

APPLICATIONS

- Offshore oil field exploration and production for use with petroleum and synthetic hydraulic oils.
Hose is not recommended for high pressure pneumatic service applications.

CONSTRUCTION

Core tube : Polyamide with stainless steel helix support (pat. pend.)*
Pressure reinforcement : High tensile aramid fibre

Cover : Polyurethane
Colour : Standard: blue, Safety identification: yellow

TEMPERATURE RANGE

-40°C up to +100°C, max. 70°C for water or methanol based fluids.
-40°F up to +212°F, max. 158°F for water or methanol based fluids.

#								
	size DN	inch mm	inch mm	psi MPa	psi MPa	inch mm	lbs/ft kg/m	
57CRN-08V02	-08	1/2	1.18	5,000	20,000	6.25	0.630	CR
	12	12.7	30.0	34.5	138.0	159	0.94	
57CRN-16V02	-16	1	2.00	5,000	20,000	10.75	10,750	CR
	25	25.4	50.8	34.5	138.0	273	15.99	

NOTES

Rated unsupported collapse resistance up to 1200 m water depth.
Additional technical information in chapter “J”.

* US patents 6,390, 141 & 6,742,545

606CR – JIC female swivel fitting

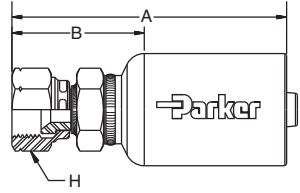

MATERIAL Stainless steel (AISI 316), other materials on request.

#	⊙		⋈	A	B	H	↗
	size DN	inch mm		inch mm	inch mm	inch mm	
606CR-8-8C	-08	1/2	3/4 - 16UNF	3.88	2.13	1.00	5,000
	12	12.7		98.6	54.1	25	34.5
606CR-16-16C	-16	1	1 5/16 - 12UNF	5.39	2.64	1.63	5,000
	25	25.4		137.0	67.0	41	34.5

2240N (V91) – polyflex® hose**MAIN FEATURES**

- Low dimensional change under pressure and results in excellent response times
- Smooth bore for low pressure drop
- Offshore safety factor standard (4:1 SF)
- Meets or exceeds the performance requirements of ISO 13628-5

APPLICATIONS

- Small OD, low volumetric expansion hose.
Long length subsea umbilical hose.







CONSTRUCTION

Core tube : Methanol washed PA11
Pressure reinforcement : High strength wire

Cover : PA12
Colour : Black

TEMPERATURE RANGE

-40°C up to +100°C, max. 70°C for water or methanol based fluids.
-40°F up to +212°F, max. 158°F for water or methanol based fluids.

#								
	size DN	inch mm	inch mm	psi MPa	psi MPa	inch mm	lbs/ft kg/m	
2240N-04V91	-04	1/4	0.46	6,250	25,000	2.8	0.11	RX
	6	6.5	11.6	43.0	172.5	70	0.17	

NOTES Additional technical information in chapter “J”.

106RX – JIC female swivel fitting

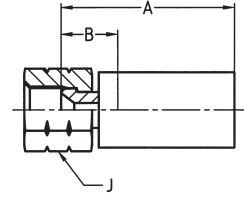

MATERIAL → Stainless steel (AISI 316), other materials on request.

#	⊙		🌀	A	B	⬡	↻
	size DN	inch mm		inch mm	inch mm	inch mm	
106RX-4-04C	-04	1/4	7/16 - 20UNF	2.24	1.02	0.75	6,250
	6	6.4		57.0	26.0	19	43.0
106RX-6-04C	-04	1/4	9/16 - 18UNF	2.17	0.94	0.75	6,250
	6	6.4		55.0	24.0	19	43.0

192RX – BSP female swivel fitting

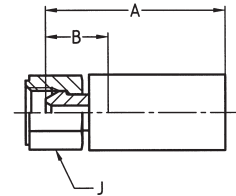

MATERIAL → Stainless steel (AISI 316), other materials on request.

#	⊙		🌀	A	B	⬡	↻
	size DN	inch mm		inch mm	inch mm	inch mm	
192RX-4-04C	-04	1/4	G 1/4	2.20	0.98	0.75	6,250
	6	6.4		56.0	25.0	19	43.0

2240N (V91)

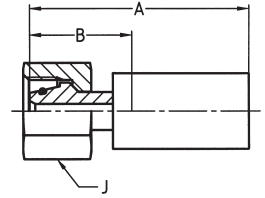
**1C9RX – Metric swivel fitting with O-ring
Heavy series****MATERIAL** Stainless steel (AISI 316), other materials on request.

#	⊙		⋈	A	B	J	↗
	size DN	inch mm					
1C9RX-8-04C	-04	1/4	M16x1.5	2.32	1.06	0.75	6,250
	6	6.4		59.0	27.0	19	43.0
1C9RX-10-04C	-04	1/4	M18x1.5	2.56	1.30	0.87	6,250
	6	6.4		65.0	33.0	22	43.0

2240N (V91)

2340N (V91) – **polyflex**® hose



MAIN FEATURES

- Low dimensional change under pressure and results in excellent response times
- Smooth bore for low pressure drop
- Offshore safety factor standard (4:1 SF)
- Meets or exceeds the performance requirements of ISO 13628-5

APPLICATIONS

- Medium pressure, low volumetric expansion hose
- Long length subsea umbilical hose
- Available in long continuous length up to 3,500 m







CONSTRUCTION

Core tube : Methanol washed PA11
Pressure reinforcement : High strength wire

Cover : PA12
Colour : Black

TEMPERATURE RANGE

-40°C up to +100°C, max. 70°C for water or methanol based fluids.
 -40°F up to +212°F, max. 158°F for water or methanol based fluids.

#								
	size DN	inch mm	inch mm	psi MPa	psi MPa	inch mm	lbs/ft kg/m	
2340N-04V91	-04	1/4	0.49	10,000	40,000	2.8	0.15	8X
	6	6.4	12.5	69.0	276.0	70	0.23	

NOTES Additional technical information in chapter “J”.

2340N (V91)

1068X – JIC female swivel fitting

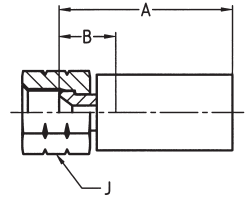

MATERIAL Stainless steel (AISI 316), other materials on request.

#	⊙		🌀	A	B	⬡	↻
	size DN	inch mm					
1068X-4-04C	-04	1/4	7/16 - 20UNF	2.24 57.0	1.02 26.0	0.75 19	10,000 69.0
	6	6.4					
1068X-6-04C	-04	1/4	9/16 - 18UNF	2.17 55.0	0.94 24.0	0.75 19	10,000 69.0
	6	6.4					

2340N (V91)

1928X – BSP female swivel fitting

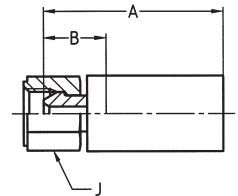

MATERIAL Stainless steel (AISI 316), other materials on request.

#	⊙		🌀	A	B	⬡	↻
	size DN	inch mm					
1928X-4-04C	-04	1/4	G 1/4	2.20 56.0	0.98 25.0	0.75 19	10,000 69.0
	6	6.4					

1C98X – Metric swivel fitting with O-ring Heavy series

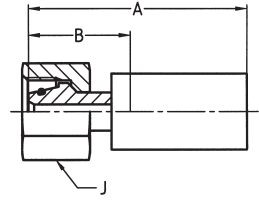

MATERIAL → Stainless steel (AISI 316), other materials on request.

#	⊙		⋈	A	B	J	↗
	size DN	inch mm		inch mm	inch mm	inch mm	
1C98X-8-04C	-04	1/4	M16x1.5	2.32	1.06	0.75	10,000
	6	6.4		59.0	27.0	19	69.0
1C98X-10-04C	-04	1/4	M18x1.5	2.56	1.30	0.87	10,000
	6	6.4		65.0	33.0	22	69.0

2340N (V91)

2370N (V91) – polyflex® hose



2370N (V91)

MAIN FEATURES

- Low dimensional change under pressure and results in excellent response times
- Smooth bore for low pressure drop
- Offshore safety factor standard (4:1 SF)
- Meets or exceeds the performance requirements of ISO 13628-5

APPLICATIONS

- Medium pressure, low volumetric expansion hose
- Long length subsea umbilical hose
- Available in long continuous length up to 2,500 m

CONSTRUCTION

Core tube : Methanol washed PA11
Pressure reinforcement : High strength wire, synthetic fibre

Cover : PA12
Colour : Black

TEMPERATURE RANGE

-40°C up to +100°C, max. 70°C for water or methanol based fluids.
 -40°F up to +212°F, max. 158°F for water or methanol based fluids.

#								
	size DN	inch mm	inch mm	psi MPa	psi MPa	inch mm	lbs/ft kg/m	
2370N-06V91	-06	3/8	0.65	6,250	25,200	4.72	0.22	RX
	10	9.7	16.5	43.0	172.5	120	0.33	

NOTES Additional technical information in chapter “J”.

106RX – JIC female swivel fitting

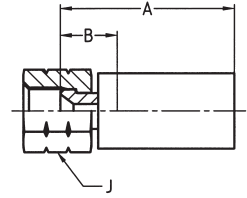

MATERIAL Stainless steel (AISI 316), other materials on request.

#	⊙		🌀	A	B	⬡	↗
	size DN	inch mm		inch mm	inch mm	inch mm	
106RX-6-06C	-06	3/8	9/16 - 18UNF	1.85	0.71	0.75	6,250
	10	9.5		47.0	18.0	19	43.0

192RX – BSP female swivel fitting

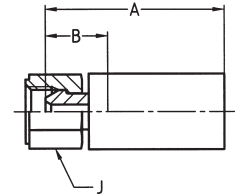

MATERIAL Stainless steel (AISI 316), other materials on request.



#	⊙		🌀	A	B	⬡	↗
	size DN	inch mm		inch mm	inch mm	inch mm	
192RX-6-06C	-06	3/8	G3/8	1.89	0.75	0.75	6,250
	10	9.5		48.0	19.0	19	43.0

2370N (V91)

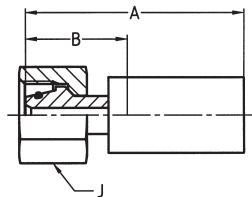
**1C9RX – Metric swivel fitting with O-ring
 Heavy series**



MATERIAL Stainless steel (AISI 316), other materials on request.

#	⊙			A	B	J	
	size DN	inch mm		inch mm	inch mm	inch mm	
1C9RX-12-06C	-06	3/8	M20x1.5	2.20	1.10	0.94	6,250
	10	9.5		56.0	28.0	24	43.0

2370N (V91)

2380N (V91) – **polyflex**[®] hose



MAIN FEATURES

- Low dimensional change under pressure and results in excellent response times
- Smooth bore for low pressure drop
- Offshore safety factor standard (4:1 SF)
- Meets or exceeds the performance requirements of ISO 13628-5

APPLICATIONS

- Small diameter, low volumetric expansion hose. Long length subsea umbilical hose.

CONSTRUCTION

Core tube : Methanol washed PA11
Pressure reinforcement : High strength wire

Cover : PA12
Colour : Black

TEMPERATURE RANGE

-40°C up to +100°C, max. 70°C for water or methanol based fluids.
 -40°F up to +212°F, max. 158°F for water or methanol based fluids.

#								
	size DN	inch mm	inch mm	psi MPa	psi MPa	inch mm	lbs/ft kg/m	
2380N-04V91	-04	1/4	0.53	10,000	40,000	2.76	0.18	8X
	6	6.4	13.4	69.0	276.0	70.0	0.27	
2380N-06V91	-06	3/8	0.70	7,500	30,000	4.70	0.30	8X
	10	9.8	17.9	51.7	207.0	120.0	0.44	
2380N-08V91	-08	1/2	0.90	7,500	30,000	5.91	0.46	8X
	12	12.9	22.9	51.7	207.0	150.0	0.68	
2380N-20V91	-20	1 1/4	1.73	4,000	16,000	15.75	1.23	NX
	32	32.0	44.0	27.5	110.0	400.0	1.83	

 product under development

NOTES Additional technical information in chapter “J”.

1068X/106NX – JIC female swivel fitting

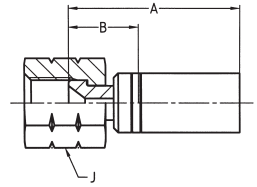

MATERIAL Stainless steel (AISI 316), other materials on request.

#	⊙		🌀	A	B	J	↗
	size DN	inch mm					
1068X-4-04C	-04	1/4	7/16 - 20UNF	2.24 57.0	1.02 26.0	0.75 19	10,000 69.0
	6	6.4					
1068X-6-04C	-04	1/4	9/16 - 18UNF	2.17 55.0	0.94 24.0	0.75 19	10,000 69.0
	6	6.4					
1068X-8-06C	-06	3/8	3/4 - 16UNF	2.32 59.0	0.75 19.0	0.94 24	7,500 51.7
	10	9.5					
1068X-10-08C	-08	1/2	7/8 - 14UNF	2.44 62.0	0.75 19.0	1.06 27	7,500 51.7
	12	12.7					
106NX-20-20C	-20	1 1/4	1 5/8 - 12UNF	3.50 89.0	1.10 28.0	1.97 50	4,000 27.5
	32	31.8					

2380N (V91)

1928X/192NX – BSP female swivel fitting

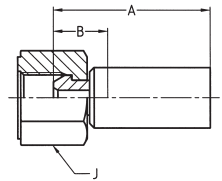

MATERIAL Stainless steel (AISI 316), other materials on request.

#	⊙		🌀	A	B	J	↗
	size DN	inch mm					
1928X-4-04C	-04	1/4	G 1/4	2.20 56.0	0.98 25.0	0.75 19	10,000 69.0
	6	6.4					
1928X-6-06C	-06	3/8	G 3/8	2.32 59.0	0.75 19.0	0.87 22	7,500 51.7
	10	9.5					
1928X-8-08C	-08	1/2	G 1/2	2.48 63.0	0.79 20.0	1.06 27	7,500 51.7
	12	12.7					
192NX-24-20C	-20	1 1/4	G 1 1/4	3.58 91.9	1.18 30.0	2.36 60	4,000 27.5
	32	31.8					

1C98X/1C9NX – Metric swivel nut with O-ring Heavy series

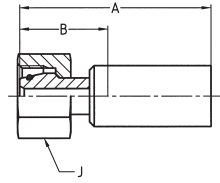

MATERIAL Stainless steel (AISI 316), other materials on request.

#	⊙		🌀	A	B	J	↻
	size DN	inch mm					
1C98X-8-04C	-04	1/4	M16 x 1.5	2.32	1.06	0.75	10,000
	6	6.4		59.0	27.0	19	69.0
1C98X-10-04C	-04	1/4	M18 x 1.5	2.56	1.30	0.87	10,000
	6	6.4		65.0	33.0	22	69.0
1C98X-12-06C	-06	3/8	M20 x 1.5	2.80	1.18	1.18	7,500
	10	9.5		71.0	30.0	30	51.7
1C98X-16-08C	-08	1/2	M24 x 1.5	3.07	1.38	1.18	7,500
	12	12.7		78.0	35.0	30	51.7
1C9NX-38-20C	-20	1 1/4	M52 x 2	4.45	2.05	2.36	4,000
	32	31.8		113.0	52.0	60	27.5

1AY8X – 59° sealing cone UNF swivel nut

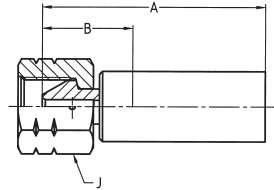

MATERIAL Stainless steel (AISI 316), other materials on request.

#	⊙		🌀	A	B	J	↻
	size DN	inch mm					
1AY8X-6-04C	-04	1/4	9/16 - 18UNF	2.68	1.38	0.67	10,000
	6	6.4		68.0	35.0	17	69.0

2380N (V91)

2390N (V91) – polyflex® hose**MAIN FEATURES**

- Low dimensional change under pressure and results in excellent response times
- Smooth bore for low pressure drop
- Offshore safety factor standard (4:1 SF)
- Meets or exceeds the performance requirements of ISO 13628-5

APPLICATIONS

- Low volumetric expansion hose.
Used in subsea umbilicals, hydraulic controls and as long length methanol injection hose.







CONSTRUCTION

Core tube : Methanol washed PA11
Pressure reinforcement : High strength wire

Cover : PA12
Colour : Black

TEMPERATURE RANGE

-40°C up to +100°C, max. 70°C for water or methanol based fluids.
-40°F up to +212°F, max. 158°F for water or methanol based fluids.

#								
	size DN	inch mm	inch mm	psi MPa	psi MPa	inch mm	lbs/ft kg/m	
2390N-06V91	-06	3/8	0.71	6,450	25,800	4.70	0.28	9X
	10	9.8	18.1	44.5	178.0	120.0	0.41	
2390N-08V91	-08	1/2	0.83	6,015	24,100	5.91	0.36	9X
	12	12.9	21.2	41.5	166.0	150.0	0.54	
2390N-12V91	-12	3/4	1.13	5,075	20,300	11.81	0.60	9X
	20	19.4	28.8	35.0	140.0	300.0	0.90	
2390N-16V91	-16	1	1.38	4,060	16,200	11.02	0.79	9X
	25	25.2	35.0	28.0	112.0	280.0	1.17	

NOTES

Additional technical information in chapter "J".

1069X – JIC female swivel fitting

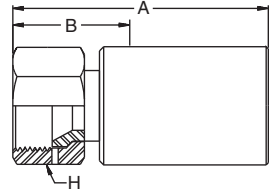

MATERIAL Stainless steel (AISI 316), other materials on request.

#	⊙		~~~~~	A	B	⬡	↗
	size DN	inch mm					
1069X-8-06C	-06	3/8	3/4 - 16UNF	2.32	0.75	0.94	10,000
	10	9.5		59.0	19.0	24	69.0
1069X-8-08C	-08	1/2	3/4 - 16UNF	2.52	0.83	1.06	10,000
	12	12.7		64.0	21.0	27	69.0
E213JFC4*	-08	1/2	3/4 - 16UNF	3.35	1.61	0.94	10,000
	12	12.7		85.0	41.0	24	69.0
1069X-12-12C	-12	3/4	1 1/16 - 12UNF	3.11	1.10	1.42	8,100
	20	19.0		79.0	28.0	36	56.0
1069X-16-16C	-16	1	1 5/16 - 12UNF	3.54	1.54	1.61	4,000
	25	25.4		90.0	39.0	41	28.0
E225JIC3*	-16	1	1 5/16 - 12UNF	4.29	2.09	1.61	6,500
	25	25.4		109.0	53.0	41	45.0

*: SubSea fittings

1929X – BSP female swivel fitting

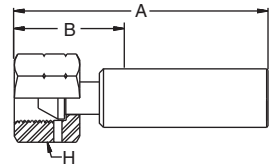

MATERIAL Stainless steel (AISI 316), other materials on request.

#	⊙		~~~~~	A	B	⬡	↗
	size DN	inch mm					
1929X-6-06C	-06	3/8	G 3/8	2.32	0.75	0.87	16,200
	10	9.5		59.0	19.0	22	112.0
1929X-8-08C	-08	1/2	G 1/2	2.48	0.79	1.06	16,400
	12	12.7		63.0	20.0	27	113.0
1929X-12-12C	-12	3/4	G 3/4	3.03	1.02	1.26	16,500
	20	19.0		77.0	26.0	32	114.0
1929X-16-16C	-16	1	G 1	3.46	1.06	1.61	16,700
	25	25.4		88.0	27.0	41	115.0

2390N (V91)

1C99X – Metric swivel nut with O-ring Heavy series

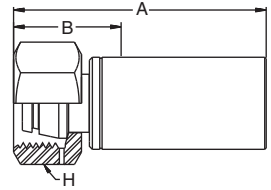

MATERIAL Stainless steel (AISI 316), other materials on request.

#	⊙		🌀	A	B	⬡	↗
	size DN	inch mm					
1C99X-12-06C	-06	3/8	M20 x 1.5	2.80	1.18	1.18	16,200
	10	9.5		71.0	30.0	30	112.0
1C99X-16-08C	-08	1/2	M24 x 1.5	3.07	1.38	1.18	16,400
	12	12.7		78.0	35.0	30	113.0
1C99X-25-12C	-12	3/4	M36 x 2	3.11	1.77	1.81	16,500
	20	19.0		79.0	45.0	46	114.0
1C99X-30-16C	-16	1	M42 x 2	3.86	1.85	1.97	16,700
	25	25.4		98.0	47.0	50	115.0

2390N (V91)

6AY9X – Type “M” female swivel fitting

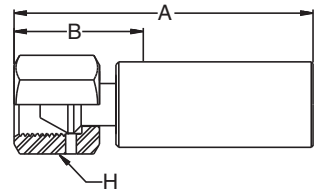

MATERIAL Stainless steel (AISI 316), other materials on request.

#	⊙		🌀	A	B	⬡	↗
	size DN	inch mm					
6AY9X-8-6C	-06	3/8	3/4 - 16UNF	2.80	1.18	0.98	10,300
	10	9.5		71.0	30.0	25	71.0
6AY9X-11-8C	-08	1/2	1 - 12UNF	3.19	1.50	1.26	10,300
	12	12.7		81.0	38.0	32	71.0
6AY9X-16-12C	-12	3/4	1 5/16 - 12UNF	4.13	1.54	1.50	8,100
	20	19.0		105.0	39.0	38	56.0
6AY9X-16-16C	-16	1	1 5/16 - 12UNF	3.78	1.65	1.50	6,500
	25	25.4		96.0	42.0	38	45.0

2440N (V91) – **polyflex**® hose



MAIN FEATURES

- Low dimensional change under pressure and results in excellent response times
- Smooth bore for low pressure drop
- Offshore safety factor standard (4:1 SF)
- Meets or exceeds the performance requirements of ISO 13628-5

APPLICATIONS

- Long length subsea umbilical hose.







CONSTRUCTION

Core tube : Methanol washed PA11
 Pressure reinforcement : High strength wire

Cover : PA12
 Colour : Black

TEMPERATURE RANGE

-40°C up to +100°C, max. 70°C for water or methanol based fluids.
 -40°F up to +212°F, max. 158°F for water or methanol based fluids.

#								
	size DN	inch mm	inch mm	psi MPa	psi MPa	inch mm	lbs/ft kg/m	
2440N-04V91	-04	1/4	0.52	12,500	50,000	5.90	0.21	LX
	6	6.4	13.1	86.5	345.0	150.0	0.31	
2440N-06V91	-06	3/8	0.77	12,500	50,000	7.50	0.50	LX
	10	9.8	19.5	86.5	345.0	190.0	0.74	
2440N-08V91	-08	1/2	0.89	11,750	46,980	5.90	0.65	LX
	12	12.7	22.7	81.0	325.0	150.0	0.97	
2440N-12V91	-12	3/4	1.18	9,135	36,250	9.80	0.98	LX
	20	19.6	30.0	63.0	250.0	250.0	1.46	
2440N-16V91	-16	1	1.46	8,120	32,625	11.80	1.28	LX
	25	25.2	37.2	56.0	225.0	300.0	1.90	

NOTES Additional technical information in chapter “J”.

2440N (V91)

106LX/606LX – JIC female swivel fitting

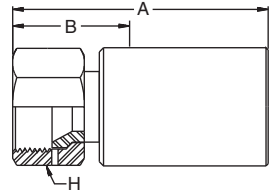

MATERIAL Stainless steel (AISI 316), other materials on request.
*Nipple made from high strength stainless steel.

#	⊙		⌚	A	B	⬡	↗
	size DN	inch mm					
106LX-6-04C	-04	1/4	9/16 - 18UNF	2.17	0.91	0.75	12,500
	6	6.4		55.0	23.0	19	86.5
106LX-6-06C	-06	3/8	9/16 - 18UNF	2.32	0.71	0.87	10,000
	10	9.5		59.0	18.0	22	69.0
106LX-8-06C	-06	3/8	3/4 - 16UNF	2.32	0.75	0.94	12,500
	10	9.5		59.0	19.0	24	86.5
106LX-8-08C	-08	1/2	3/4 - 16UNF	2.52	0.83	1.06	10,000
	12	12.7		64.0	21.0	27	69.0
106LX-16-12C	-12	3/4	1 5/16 - 12UNF	4.29	1.69	1.61	9,100
	20	19.0		109.0	43.0	41	63.0
606LX-16-16C*	-16	1	1 5/16 - 12UNF	3.78	1.65	1.61	10,000
	25	25.4		96.0	42.0	41	69.0

2440N (V91)

1C9LX/6C9LX – Metric swivel with O-ring Heavy series

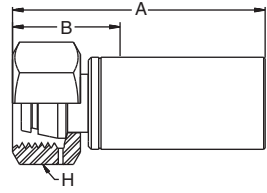

MATERIAL Stainless steel (AISI 316), other materials on request.
*Nipple made from high strength stainless steel.

#	⊙		⌚	A	B	H	↻
	size DN	inch mm		inch mm	inch mm	inch mm	psi MPa
1C9LX-10-04C	-04	1/4	M18 x 1.5	2.76	1.30	0.87	20,300
	6	6.4		70.0	33.0	22	140.0
1C9LX-14-06C	-06	3/8	M22 x 1.5	2.99	1.18	1.18	12,500
	10	9.5		76.0	30.0	30	86.5
1C9LX-16-08C	-08	1/2	M24 x 1.5	3.46	1.34	1.26	11,700
	12	12.7		88.0	34.0	32	81.0
1C9LX-25-12C	-12	3/4	M36 x 2	4.25	1.57	1.81	9,100
	20	19.0		108.0	40.0	46	63.0
6C9LX-30-16C*	-16	1	M42 x 2	5.47	1.77	2.17	13,050
	25	25.4		139.0	45.0	55	90.0

6AYLX – Type “M” female swivel fitting

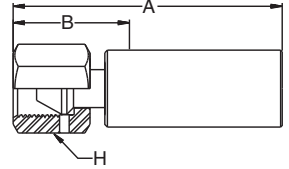

MATERIAL Nipple made from high strength stainless steel, nut and shell stainless steel (AISI 316), other materials on request.
*: Nipple made from high corrosion resistant steel, nut and shell stainless steel (AISI 316).

#	⊙		⌚	A	B	⬡	↻
	size DN	inch mm					
6AYLX-6-4C-SD*	-04	1/4	9/16 - 18UNF	2.68	1.38	0.67	20,300
	6	6.4		68.0	35.0	17	140.0
6AYLX-11-8C-SD*	-08	1/2	1 - 12UNF	3.54	1.50	1.26	18,850
	12	12.7		90.0	38.0	32	130.0
6AYLX-16-12C-SD*	-12	3/4	1 5/16 - 12UNF	4.29	1.65	1.50	14,500
	20	19.0		109.0	42.0	38	100.0
6AYLX-16-16C	-16	1	1 5/16 - 12UNF	5.47	2.05	1.50	13,050
	25	25.4		139.0	52.0	38	90.0
6AYLX-16-16C-SD*	-16	1	1 5/16 - 12UNF	5.47	2.05	1.50	13,050
	25	25.4		139.0	52.0	38	90.0

1AYLX – Type “M” female swivel fitting

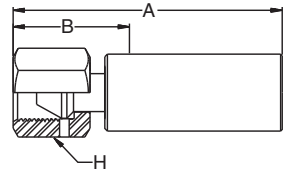

MATERIAL Stainless steel (AISI 316), other materials on request.

#	⊙		⌚	A	B	⬡	↻
	size DN	inch mm					
1AYLX-6-04C	-04	1/4	9/16 - 18UNF	2.95	1.26	0.87	12,500
	6	6.4		75.0	32.0	22	86.5
1AYLX-8-06C	-06	3/8	3/4 - 16UNF	2.95	1.26	0.98	11,700
	10	9.5		75.0	32.0	25	81.0
1AYLX-11-08C	-08	1/2	1 - 12UNF	3.54	1.50	1.26	11,700
	12	12.7		90.0	38.0	32	81.0
1AYLX-16-12C	-12	3/4	1 5/16 - 12UNF	3.54	1.50	1.61	9,100
	20	19.0		90.0	38.0	41	63.0

2440N (V91)

2448N (V91) – **polyflex**® hose



MAIN FEATURES

- Low dimensional change under pressure and results in excellent response times
- Smooth bore for low pressure drop
- Offshore safety factor standard (4:1 SF)
- Meets or exceeds the performance requirements of ISO 13628-5

APPLICATIONS

- Long length subsea umbilical hose.







CONSTRUCTION

Core tube : Methanol washed PA11
 Pressure reinforcement : High strength wire

Cover : PA12
 Colour : Black

TEMPERATURE RANGE

-40°C up to +100°C, max. 70°C for water or methanol based fluids.
 -40°F up to +212°F, max. 158°F for water or methanol based fluids.

#								
	size DN	inch mm	inch mm	psi MPa	psi MPa	inch mm	lbs/ft kg/m	
2448N-04V91	-04	1/4	0.54	15,000	60,000	5.91	0.57	8X
	6	6.3	13.8	103.5	414.0	150.0	0.38	
2448N-06V91	-06	3/8	0.80	15,000	60,000	7.50	1.10	*
	10	9.7	20.3	103.5	414.0	190.0	0.74	

 product under development

*: consult factory

NOTES Additional technical information in chapter “J”.

2448N (V91)

1AY8X – Type “M” female swivel fitting

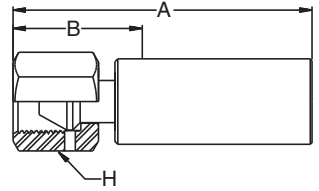

MATERIAL Stainless steel (AISI 316), other materials on request.

#	⊙		🌀	A	B	⬡	↗
	size DN	inch mm					
1AY8X-6-04C	-04	1/4	9/16 - 18UNF	2.68 68.0	1.38 35.0	0.67 17	15,000 103.5
	6	6.4					
1AY8X-8-06C	-06	3/8	3/4 - 16UNF	2.95 75.0	1.26 32.0	0.98 25	15,000 103.5
	10	9.5					

2448N (V91)

1Y28X – Medium pressure tube nipple

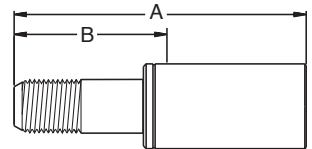

MATERIAL Stainless steel (AISI 316), other materials on request.

#	⊙		🌀	A	B	↗
	size DN	inch mm				
1Y28X-6-04C	-04	1/4	3/8 - 24 LH	4.29 109.0	2.20 56.0	15,000 103.5
	6	6.4				
1Y28X-9-06C	-06	3/8	9/16 - 18 LH	4.21 107.0	2.09 53.0	15,000 103.5
	10	9.5				

2640N (V91) – **polyflex**® hose



MAIN FEATURES

- Low dimensional change under pressure and results in excellent response times
- Smooth bore for low pressure drop
- Offshore safety factor standard (4:1 SF)
- Meets or exceeds the performance requirements of ISO 13628-5

APPLICATIONS

- Ultra high pressure umbilical hose.







CONSTRUCTION

Core tube : Methanol washed PA11
 Pressure reinforcement : High strength wire

Cover : PA12
 Colour : Black

TEMPERATURE RANGE

-40°C up to +100°C, max. 70°C for water or methanol based fluids.
 -40°F up to +212°F, max. 158°F for water or methanol based fluids.

#								
	size DN	inch mm	inch mm	psi MPa	psi MPa	inch mm	lbs/ft kg/m	
2640N-08V91	-08	1/2	0.98	15,000	60,000	11.40	0.90	5X
	12	12.8	24.8	103.5	414.0	290.0	1.34	
2640N-12V91	-12	3/4	1.31	12,500	50,800	13.80	1.45	5X
	20	19.8	33.2	86.5	350.0	350.0	2.16	
2640N-16V91	-16	1	1.59	10,900	43,500	15.80	1.91	5X
	25	26.0	40.4	75.0	300.0	400.0	2.84	

 product under development

NOTES Additional technical information in chapter “J”.

2640N (V91)

6AY5X – Type “M” female swivel fitting

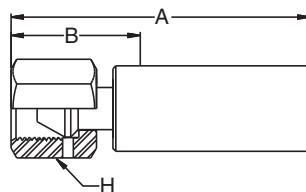

MATERIAL Nipple high strength stainless steel, nut and shell stainless steel (AISI 316), other materials on request.
*: SubSea fittings; nipple high corrosion resistant steel, nut and shell stainless steel (AISI 316).

#	⊙		🌀	A	B	⬡	↻
	size DN	inch mm					
6AY5X-11-8C	-08	1/2	1 - 12UNF	4.25	1.73	1.26	16,400
	12	12.7		108.0	44.0	32	113.0
6AY5X-16-12C	-12	3/4	3/4 - 14NPTF	4.25	1.54	1.50	12,700
	20	19.0		108.0	39.0	38	87.5
6AY5X-16-12C-SD*	-12	3/4	3/4 - 14NPTF	4.25	1.54	1.50	12,700
	20	19.0		108.0	39.0	38	87.5
6AY5X-16-16C	-16	1	1 - 1 1/2NPTF	5.47	2.05	1.50	10,900
	25	25.4		139.0	52.0	38	75.0
6AY5X-16-16C-SD*	-16	1	1 - 1 1/2NPTF	5.47	2.05	1.50	10,900
	25	25.4		139.0	52.0	38	75.0

2640N (V91)

6Y25X – Medium pressure tube nipple

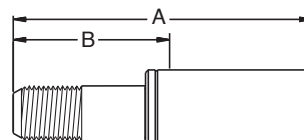

MATERIAL Nipple high strength stainless steel, shell stainless steel (AISI 316), other materials on request.

#	⊙		🌀	A	B	ØR	↻
	size DN	inch mm					
6Y25X-9-8C	-08	1/2	9/16 - 18 LH	4.29	2.20	1.26	16,400
	12	12.7		109.0	56.0	32.0	113.0
6Y25X-12-8C	-08	1/2	3/4 - 16 LH	4.21	2.09	1.26	16,400
	12	12.7		107.0	53.0	32.0	113.0
6Y25X-16-12C	-12	3/4	1 - 14 LH	5.47	2.76	1.69	12,700
	20	19.0		139.0	70.0	43.0	87.5

6C95X – Metric swivel nut with O-ring Heavy series

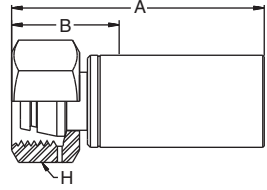

MATERIAL Nipple high strength stainless steel, nut and shell stainless steel (AISI 316), other materials on request.

#	⊙		⌚	A	B	H	↗
	size DN	inch mm		inch mm	inch mm	inch mm	
6C95X-16-08C	-08	1/2	M24 x 1.5	3.58	1.46	1.26	16,400
	12	12.7		91.0	37.0	32	113.0
6C95X-25-12C	-12	3/4	M36 x 2	4.37	1.61	1.81	12,700
	20	19.0		111.0	41.0	46	87.5
	25	25.4		121.0	55.0	50	75.0

2640N (V91)

2240M (V30) – polyflex® hose
ChemJec**MAIN FEATURES**

- Withstands high pressure cycles with no signs of stress cracking.
- Proven to handle methanol.
- High collapse resistance (HCR) and also providing longer service life
- Extremely low permeability.
- Meets or exceeds the performance requirements of ISO 13628-5

APPLICATIONS

- Medium pressure, high temperature, low volumetric expansion hose.
- Excellent chemical resistance.
- Long length subsea umbilical hose.
- Available in long continuous length up to 3,000 m.

CONSTRUCTION







Core tube : Coextruded core tube with fluoropolymer inside
Pressure reinforcement : High strength wire

Cover : PA12
Colour : Black

TEMPERATURE RANGE

-40°C up to +100°C, short term 125°C
 -40°F up to +212°F, short term 257°F

2240M (V30)

#								
	size DN	inch mm	inch mm	psi MPa	psi MPa	inch mm	lbs/ft kg/m	
2240M-04V30	-04	1/4	0.46	6,250	25,000	4.70	0.11	RX
	6	6.4	11.7	43.0	172.5	120.0	0.17	

NOTES Additional technical information in chapter “J”.

106RX – JIC female swivel fitting

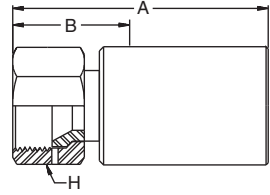

MATERIAL → Stainless steel (AISI 316), other materials on request.

#	⊙		~~~~~	A	B	⬡	↻
	size DN	inch mm		inch mm	inch mm	inch mm	psi MPa
106RX-4-04C	-04	1/4	7/16 - 20UNF	2.24	1.02	0.75	6,250
	6	6.4		57.0	26.0	19	43.0
106RX-6-04C	-04	1/4	9/16 - 18UNF	2.17	0.94	0.75	6,250
	6	6.4		55.0	24.0	19	43.0

192RX – BSP female swivel fitting

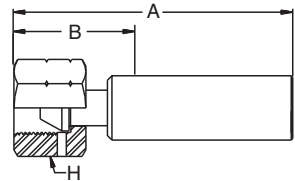

MATERIAL → Stainless steel (AISI 316), other materials on request.

#	⊙		~~~~~	A	B	⬡	↻
	size DN	inch mm		inch mm	inch mm	inch mm	psi MPa
192RX-4-04C	-04	1/4	G 1/4	2.20	0.98	0.75	6,250
	6	6.4		56.0	25.0	19	43.0

2240M (V30)

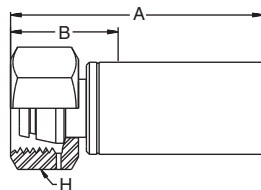
**1C9RX – Metric swivel fitting with O-ring
Heavy series****MATERIAL** Stainless steel (AISI 316), other materials on request.

#	⊙		⌚	A	B	H	↗
	size DN	inch mm					
1C9RX-8-04C	-04	1/4	M16 x 1.5	2.32	1.06	0.75	6,250
	6	6.4		59.0	27.0	19	43.0
1C9RX-10-04C	-04	1/4	M18 x 1.5	2.56	1.30	0.87	6,250
	6	6.4		65.0	33.0	22	43.0

2240M (V30)

2340M (V30) – **polyflex**[®] hose **ChemJec**



MAIN FEATURES

- Withstands high pressure cycles with no signs of stress cracking.
- Proven to handle methanol.
- High collapse resistance (HCR) and also providing longer service life
- Extremely low permeability.
- Meets or exceeds the performance requirements of ISO 13628-5

APPLICATIONS

- High pressure, high temperature, low volumetric expansion hose.
- Long length subsea umbilical hose.
- Excellent chemical resistance.
- Available in long continuous length up to 3,000 m.

CONSTRUCTION

Core tube : Coextruded core tube with fluoropolymer inside
Pressure reinforcement : High strength wire

Cover : PA12
Colour : Black

TEMPERATURE RANGE

-40°C up to +100°C, short term 125°C
 -40°F up to +212°F, short term 257°F

#								
	size DN	inch mm	inch mm	psi MPa	psi MPa	inch mm	lbs/ft kg/m	
2340M-04V30	-04	1/4	0.49	10,000	40,000	9.1	0.15	8X
	6	6.4	12.5	69.0	280.0	230	0.23	

NOTES Additional technical information in chapter “J”.

1068X – JIC female swivel fitting

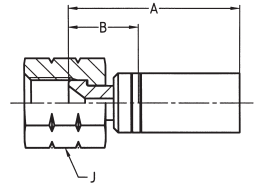

MATERIAL Stainless steel (AISI 316), other materials on request.

#	⊙		⌚	A	B	J	↻
	size DN	inch mm					
1068X-4-04C	-04	1/4	7/16 - 20UNF	2.24 57.0	1.02 26.0	0.75 19	10,000 69.0
	6	6.4					
1068X-6-04C	-04	1/4	9/16 - 18UNF	2.17 55.0	0.94 24.0	0.75 19	10,000 69.0
	6	6.4					

2340M (V30)

1928X – BSP female swivel fitting

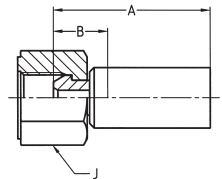

MATERIAL Stainless steel (AISI 316), other materials on request.

#	⊙		⌚	A	B	J	↻
	size DN	inch mm					
1928X-4-04C	-04	1/4	G 1/4	2.20 56.0	0.98 25.0	0.75 19	10,000 69.0
	6	6.4					

1C98X – Metric swivel nut with O-ring Heavy series

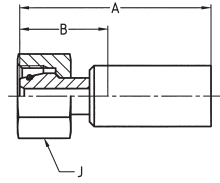

MATERIAL → Stainless steel (AISI 316), other materials on request.

#	⊙		⌚	A	B	J	↗
	size DN	inch mm		inch mm	inch mm	inch mm	
1C98X-8-04C	-04	1/4	M16 x 1.5	2.32	1.06	0.75	10,000
	6	6.4		59.0	27.0	19	
1C98X-10-04C	-04	1/4	M18 x 1.5	2.56	1.30	0.87	10,000
	6	6.4		65.0	33.0	22	

1AY8X – 59° sealing cone UNF swivel nut

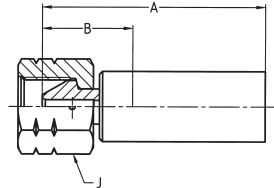

MATERIAL → Stainless steel (AISI 316), other materials on request.

#	⊙		⌚	A	B	J	↗
	size DN	inch mm		inch mm	inch mm	inch mm	
1AY8X-6-04C	-04	1/4	9/16 - 18UNF	2.68	1.38	0.67	10,000
	6	6.4		68.0	35.0	17	

2340M (V30)

2370M (V30) – polyflex® hose
ChemJec**MAIN FEATURES**

- Withstands high pressure cycles with no signs of stress cracking.
- Proven to handle methanol.
- High collapse resistance (HCR) and also providing longer service life
- Extremely low permeability.
- Meets or exceeds the performance requirements of ISO 13628-5

APPLICATIONS

- Medium pressure, high temperature, low volumetric expansion hose.
- Long length subsea umbilical hose.
- Excellent chemical resistance.
- Available in long continuous length up to 2,500 m.

CONSTRUCTION

Core tube : Coextruded core tube with fluoropolymer inside
Pressure reinforcement : High strength wire, synthetic fibre

Cover : PA12
Colour : Black

TEMPERATURE RANGE

-40°C up to 125°C
 -40°F up to 257°F

2370M (V30)

#								
	size DN	inch mm	inch mm	psi MPa	psi MPa	inch mm	lbs/ft kg/m	
2370M-06V30	-06	3/8	0.65	6,250	25,000	4.70	0.22	RX
	10	9.9	16.6	43.0	172.5	120.0	0.33	

NOTES Additional technical information in chapter “J”.

106RX – JIC female swivel fitting

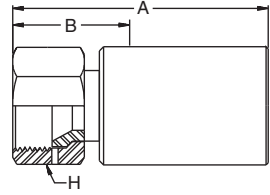

MATERIAL → Stainless steel (AISI 316), other materials on request.

#	⊙		~~~~~	A	B	⬡	↗
	size DN	inch mm		inch mm	inch mm	inch mm	psi MPa
106RX-6-06C	-06	3/8	9/16 - 18UNF	1.85	0.71	0.75	6,250
	10	9.5		47.0	18.0	19	43.0

192RX – BSP female swivel fitting

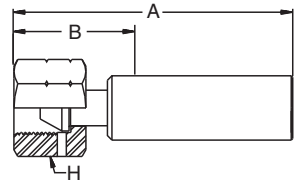



MATERIAL → Stainless steel (AISI 316), other materials on request.

#	⊙		~~~~~	A	B	⬡	↗
	size DN	inch mm		inch mm	inch mm	inch mm	psi MPa
192RX-6-06C	-06	3/8	G 3/8	1.89	0.75	0.87	6,250
	10	9.5		48.0	19.0	22	43.0

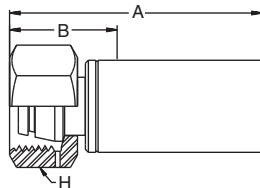
**1C9RX – Metric swivel nut with O-ring
 Heavy series**



MATERIAL Stainless steel (AISI 316), other materials on request.

#	⊙			A	B	H	
	size DN	inch mm		inch mm	inch mm	inch mm	psi MPa
1C9RX-12-06C	-06	3/8	M20 x 1.5	2.20	1.10	0.94	6,250
	10	9.5		56.0	28.0	24	43.0

2370M (V30)

2380M (V30) – **polyflex**[®] hose **ChemJec**



MAIN FEATURES

- Withstands high pressure cycles with no signs of stress cracking.
- Proven to handle methanol.
- High collapse resistance (HCR) and also providing longer service life
- Extremely low permeability.
- Meets or exceeds the performance requirements of ISO 13628-5

APPLICATIONS

- High pressure, high temperature, low volumetric expansion hose.
- Long length subsea umbilical hose.
- Excellent chemical resistance.
- Available in long continuous length up to 3,000 m.







CONSTRUCTION

Core tube : Coextruded core tube with fluoropolymer inside
Pressure reinforcement : High strength wire

Cover : PA12
Colour : Black

TEMPERATURE RANGE

-40°C up to +100°C, short term 125°C
 -40°F up to +212°F, short term 257°F

#								
	size DN	inch mm	inch mm	psi MPa	psi MPa	inch mm	lbs/ft kg/m	
2380M-04V30	-04	1/4	0.53	10,000	40,000	9.10	0.18	8X/LX
	6	6.4	13.4	69.0	280.0	230	0.27	
2380M-05V30	-05	5/16	0.62	8,700	34,800	3.50	0.23	*
	8	8.2	15.7	60.0	240.0	90	0.34	

*: consult factory

NOTES Additional technical information in chapter “J”.

2380M (V30)

1AY8X/6AYLX – Type “M” female swivel fitting

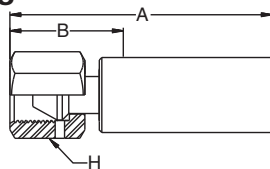

MATERIAL Stainless steel (AISI 316), other materials on request. *Nipple made from high strength, high corrosion resistant steel, nut and shell stainless steel (AISI 316).

#	⊙		~~~~~	A	B	H	↻
	size DN	inch mm					
1AY8X-6-04C	-04	1/4	9/16 - 18UNF	2.68	1.38	0.67	10,000
	6	6.4		68.0	35.0		
6AYLX-6-4C-M-Subsea*	-04	1/4	9/16 - 18UNF	2.56	1.30	0.75	10,000
	6	6.4		65.0	33.0		

*: welded subsea fitting

1068X/606LX – JIC female swivel fitting

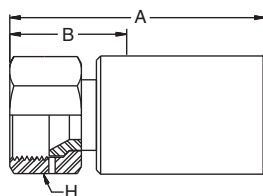

MATERIAL Stainless steel (AISI 316), other materials on request. *Nipple made from high strength, high corrosion resistant steel, nut and shell stainless steel (AISI 316).

#	⊙		~~~~~	A	B	H	↻
	size DN	inch mm					
1068X-4-04C	-04	1/4	7/16 - 20UNF	2.24	1.02	0.75	10,000
	6	6.4		57.0	26.0		
1068X-6-04C	-04	1/4	9/16 - 18UNF	2.17	0.94	0.75	10,000
	6	6.4		55.0	24.0		
606LX-6-4C-M-Subsea*	-04	1/4	9/16 - 18UNF	2.36	1.10	0.67	10,000
	6	6.4		60.0	28.0		

*: welded subsea fitting

2380M (V30)

1928X – BSP female swivel fitting

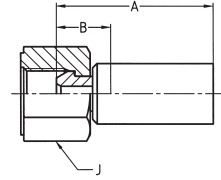

MATERIAL → Stainless steel (AISI 316), other materials on request.

#	⊙		⌚	A	B	J	↻
	size DN	inch mm		inch mm	inch mm	inch mm	
1928X-4-04C	-04	1/4	G 1/4	2.20	0.98	0.75	10,000
	6	6.4		56.0	25.0	19	69.0

1C98X – Metric swivel nut with O-ring Heavy series

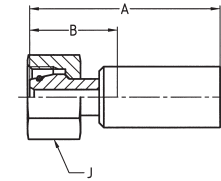



MATERIAL → Stainless steel (AISI 316), other materials on request.

#	⊙		⌚	A	B	J	↻
	size DN	inch mm		inch mm	inch mm	inch mm	
1C98X-8-04C	-04	1/4	M16 x 1.5	2.32	1.06	0.75	10,000
	6	6.4		59.0	27.0	19	69.0
1C98X-10-04C	-04	1/4	M18 x 1.5	2.56	1.30	0.87	10,000
	6	6.4		65.0	33.0	22	69.0

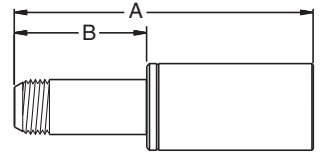
2380M (V30)

1Y28X – Medium pressure tube nipple



MATERIAL Stainless steel (AISI 316), other materials on request.

#	⊙			A	B	
	size DN	inch mm		inch mm	inch mm	
1Y28X-6-4C	-04	1/4	3/8 - 24 UNF	3.70	2.36	10,000
	6	6.4		94.0	60.0	69.0

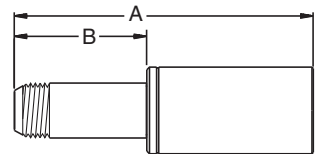
2380M (V30)

6Y2LX/1Y2LX – Medium pressure tube nipple

MATERIAL Stainless steel (AISI 316), nipple made from super duplex, other materials on request. INC625: Inconel fitting.

#	⊙			A	B	
	size DN	inch mm		inch mm	inch mm	
6Y2LX-6-4C-M-Subsea*	-04	1/4	3/8 - 24 UNF-LH	5.20	3.20	10,000
	6	6.4		132.0	80.0	69.0
1Y2LX-6-04M-INC625*	-04	1/4	3/8 - 24 UNF-LH	5.20	3.20	10,000
	6	6.4		132.0	80.0	69.0

*: welded subsea fitting

2390M (V30) – **polyflex**[®] hose **ChemJec**



MAIN FEATURES

- Low dimensional change under pressure and results in excellent response times
- Smooth bore for low pressure drop
- Offshore safety factor standard (4:1 SF)
- Meets or exceeds the performance requirements of ISO 13628-5

APPLICATIONS

- Low volumetric expansion hose.
Used in subsea umbilicals, hydraulic controls and as long length methanol injection hose.

CONSTRUCTION

Core tube : Coextruded core tube with fluoropolymer inside
Pressure reinforcement : High strength wire

Cover : PA12
Colour : Black

TEMPERATURE RANGE

-40°C up to +100°C, short term 125°C, 720 hrs.
 -40°F up to +212°F, short term 257°F

#								
	size DN	inch mm	inch mm	psi MPa	psi MPa	inch mm	lbs/ft kg/m	
2390M-12V30	-12	3/4	1.14	5,000	20,000	11.81	0.60	9X
	20	19.4	29.0	34.5	138.0	300.0	0.90	
2390M-16V30	-16	1	1.38	4,060	16,240	11.00	0.78	9X
	25	25.4	35.0	28.0	112.0	280.0	1.17	

product under development

NOTES

1069X – JIC female swivel fitting

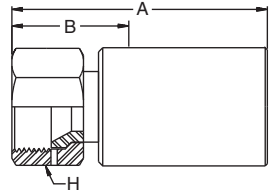

MATERIAL Stainless steel (AISI 316), other materials on request.

#	⊙		⌚	A	B	⬡	↻
	size DN	inch mm					
1069X-12-12C	-12	3/4	1 1/16 - 12UNF	3.11 79.0	1.10 28.0	1.42 36	8,100 56.0
	20	19.0					

2390M (V30)

1929X – BSP female swivel fitting

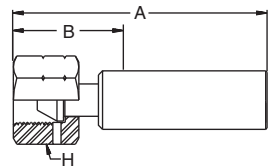

MATERIAL Stainless steel (AISI 316), other materials on request.

#	⊙		⌚	A	B	⬡	↻
	size DN	inch mm					
1929X-12-12C	-12	3/4	G 3/4	3.03 77.0	1.02 26.0	1.26 32	8,100 56.0
	20	19.0					

1C99X – Metric swivel nut with O-ring Heavy series

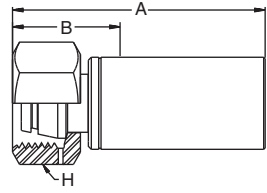

MATERIAL Stainless steel (AISI 316), other materials on request.

#	⊙		~~~~~	A	B	H	↗
	size DN	inch mm		inch mm	inch mm	inch mm	
1C99X-25-12C	-12 20	3/4 19.0	M36 x 2	3.11 79.0	1.77 45.0	1.81 46	8,100 56.0

1AY9X – Type “M” female swivel fitting

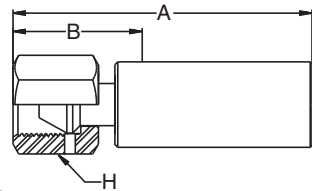

MATERIAL Stainless steel (AISI 316), other materials on request.

#	⊙		~~~~~	A	B	H	↗
	size DN	inch mm		inch mm	inch mm	inch mm	
1AY9X-16-12C	-12 20	3/4 19.0	1 5/16 - 12UNF	4.13 105.0	1.54 39.0	1.50 38	8,100 56.0

2390M (V30)

2440M (V30) – polyflex® hose
ChemJec**MAIN FEATURES**

- Withstands high pressure cycles with no signs of stress cracking.
- Proven to handle methanol.
- High collapse resistance (HCR) and also providing longer service life
- Extremely low permeability.
- Meets or exceeds the performance requirements of ISO 13628-5

APPLICATIONS

- High pressure, high temperature, low volumetric expansion hose.
- Long length subsea umbilical hose.
- Excellent chemical resistance.
- Available in long continuous length up to 3,000 m.

CONSTRUCTION

Core tube : Coextruded core tube with fluoropolymer inside
Pressure reinforcement : High strength wire

Cover : PA12
Colour : Black

TEMPERATURE RANGE

-40°C up to +100°C, short term 125°C
 -40°F up to +212°F, short term 257°F

#														
	size DN	inch mm	inch mm	psi MPa	psi MPa	inch mm	lbs/ft kg/m							
2440M-04V30	-04	1/4	0.52	12,500	50,000	5.90	0.21							8X
	6	6.4	13.1	86.5	345.0	150.0	0.31							
2440M-05V30	-05	5/16	0.63	10,000	40,000	6.90	0.33							LX
	8	8.1	16.0	69.0	276.0	175.0	0.49							
2440M-06V30	-06	3/8	0.77	10,000	40,000	7.50	0.49							LX
	10	9.9	19.5	69.0	276.0	190.0	0.73							
2440M-08V30	-08	1/2	0.89	10,000	40,000	7.90	0.63							LX
	12	12.9	22.7	69.0	276.0	200.0	0.94							
2440M-12V30	-12	3/4	1.19	9,135	36,250	9.80	0.98							LX*
	20	19.8	30.2	63.0	250.0	250.0	1.46							
2440M-16V30	-16	1	1.46	8,120	32,625	11.80	1.28							LX
	25	25.2	37.2	56.0	225.0	300.0	1.90							

product under development

NOTES

Additional technical information in chapter "J".

106LX/1068X – JIC female swivel fitting

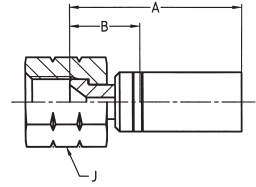

MATERIAL Stainless steel (AISI 316), other materials on request.
*Nipple made from duplex steel, shell and nut stainless steel (AISI 316).

#	⊙		⌚	A	B	J	↻
	size DN	inch mm					
1068X-6-04C	-04	1/4	9/16 - 18UNF	2.17	0.91	0.75	12,500
	6	6.4		55.0	23.0	19	86.5
106LX-6-06C-M-Subsea	-06	3/8	9/16 - 18UNF	2.32	0.71	0.87	10,000
	10	9.5		59.0	18.0	22	69.0
106LX-8-06C-M-Subsea	-06	3/8	3/4 - 16UNF	2.32	0.75	0.94	10,000
	10	9.5		59.0	19.0	24	69.0
106LX-8-08C-M-Subsea	-08	1/2	3/4 - 16UNF	2.52	0.83	1.06	10,000
	12	12.7		64.0	21.0	27	69.0
106LX-16-12C-M*	-12	3/4	1 5/16 - 12UNF	4.29	1.69	1.61	9,100
	20	19.0		109.0	43.0	41	63.0

1C9LX – Metric swivel with O-ring Heavy series

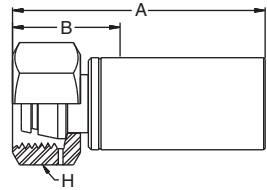

MATERIAL Stainless steel (AISI 316), other materials on request.
*Nipple made from duplex steel, shell and nut stainless steel (AISI 316).

#	⊙		⌚	A	B	H	↻
	size DN	inch mm					
1C98X-8-04C	-04	1/4	M16x1.5	2.32	1.06	0.75	10,000
	6	6.4		59.0	27.0	19	69.0
1C98X-10-04C	-04	1/4	M18 x 1.5	2.76	1.30	0.87	12,500
	6	6.4		70.0	33.0	22	86.5
1C9LX-14-06C-M-Subsea	-06	3/8	M22 x 1.5	2.99	1.18	1.18	12,500
	10	9.5		76.0	30.0	30	86.5
1C9LX-16-08C-M-Subsea	-08	1/2	M24 x 1.5	3.46	1.34	1.26	11,700
	12	12.7		88.0	34.0	32	81.0
1C9LX-25-12C-M*	-12	3/4	M36 x 2	4.25	1.57	1.81	9,100
	20	19.0		108.0	40.0	46	63.0

2440M (V30)

2448M (V30) – polyflex® hose
ChemJec**MAIN FEATURES**

- Withstands high pressure cycles with no signs of stress cracking.
- Proven to handle methanol.
- High collapse resistance (HCR) and also providing longer service life
- Extremely low permeability.
- Meets or exceeds the performance requirements of ISO 13628-5

APPLICATIONS

- Long length subsea umbilical hose.

CONSTRUCTION

Core tube : Coextruded core tube with fluoropolymer inside
Pressure reinforcement : High strength wire

Cover : PA12
Colour : Black

TEMPERATURE RANGE

-40°C up to +100°C, short term 125°C
 -40°F up to +212°F, short term 257°F

#								
	size DN	inch mm						
2448M-04V30	-04	1/4	0.54	15,000	60,000	9.10	0.26	UX
	6	6.4	13.7	103.5	414.0	230.0	0.38	
2448M-05V30	-05	5/16	0.64	15,000	60,000	9.10	0.35	UX
	8	8.2	16.3	103.5	414.0	230.0	0.52	
2448M-06V30	-06	3/8	0.80	15,000	60,000	7.90	0.56	UX
	10	9.8	20.1	103.5	414.0	200.0	0.83	

NOTES

Additional technical information in chapter "J".

1AYUX – Type “M” female swivel fitting

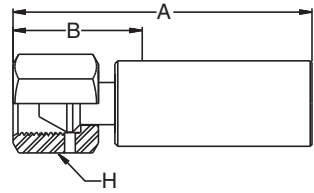

MATERIAL Nipple high strength corrosion resistant material, shell and nut Stainless steel (AISI 316), other materials on request.

#	⊙		~~~~~	A	B	⬡	↻
	size DN	inch mm		inch mm	inch mm	inch mm	
1AYUX-6-04C	-04	1/4	9/16 - 18UNF	3.66	1.38	0.67	15,000
	6	6.4		93.0	35.0	17	
1AYUX-8-05C	-05	5/19	3/4 - 16UNF	3.94	1.38	1.06	15,000
	8	7.9		100.0	35.0	27	
1AYUX-8-06C	-06	3/8	3/4 - 16UNF	3.94	1.38	1.06	15,000
	10	9.5		100.0	35.0	27	

1Y2UX – Medium pressure tube nipple

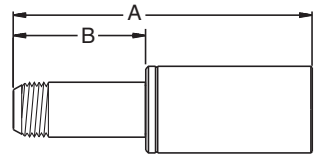

MATERIAL Nipple high strength corrosion resistant material, shell Stainless steel (AISI 316), other materials on request.

#	⊙		~~~~~	A	B	↻
	size DN	inch mm		inch mm	inch mm	
1Y2UX-6-04C	-04	1/4	3/8 - 24UNF-LH	4.29	2.20	15,000
	6	6.4		109.0	56.0	
1Y2UX-6-05C	-05	5/16	3/8 - 24UNF-LH	4.84	2.24	15,000
	8	7.9		123.0	57.0	
1Y2UX-9-06C	-06	3/8	9/16 - 18UNF-LH	4.84	2.24	15,000
	10	9.5		123.0	57.0	

2640M (V30) – polyflex® hose
ChemJec**MAIN FEATURES**

- Withstands high pressure cycles with no signs of stress cracking.
- Proven to handle methanol.
- High collapse resistance (HCR) and also providing longer service life
- Extremely low permeability.
- Meets or exceeds the performance requirements of ISO 13628-5

APPLICATIONS

- Medium pressure, high temperature, low volumetric expansion hose.
- Long length subsea umbilical hose.
- Excellent chemical resistance.
- Available in long continuous length up to 3,000 m.

CONSTRUCTION

Core tube : Coextruded core tube with fluoropolymer inside
Pressure reinforcement : High strength wire

Cover : PA12
Colour : Black

TEMPERATURE RANGE

-40°C up to +100°C, short term 125°C
 -40°F up to +212°F, short term 257°F

#								
	size DN	inch mm						
2640M-08V30	-08 12	1/2 12.7	0.97 24.7	15,000 103.5	60,000 414.0	7.90 200.0	0.58 0.86	5X

NOTES Additional technical information in chapter "J".

1AY5X – Type “M” female swivel fitting

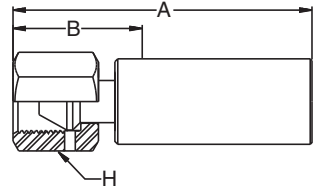

MATERIAL Nipple high strength corrosion resistant material, shell and nut Stainless steel (AISI 316), other materials on request.

#	⊙		🌀	A	B	⬡	↻
	size DN	inch mm		inch mm	inch mm	inch mm	psi MPa
1AY5X-11-08C-M-Subsea	-08	1/2	3/4 - 16UNF	2.52	0.83	1.06	15,000
	12	12.7		64.0	21.0	27	103.0

1C95X – Metric swivel with O-ring Heavy series

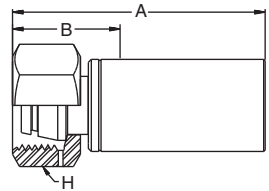

MATERIAL Nipple high strength corrosion resistant material, shell and nut Stainless steel (AISI 316), other materials on request.

#	⊙		🌀	A	B	⬡	↻
	size DN	inch mm		inch mm	inch mm	inch mm	psi MPa
1C95X-16-08C-M-Subsea	-08	1/2	M24 x 1.5	3.46	1.34	1.26	15,000
	12	12.7		88.0	34.0	32	103.0

2640M (V30)

1Y25X – Medium pressure tube nipple

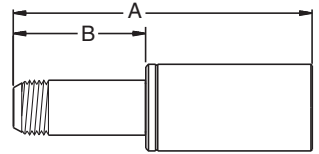

MATERIAL Nipple high strength corrosion resistant material, shell Stainless steel (AISI 316), other materials on request.

#	⊙		🌀	A	B	↗
	size DN	inch mm		inch mm	inch mm	
1Y25X-9-08C-M-Subsea	-08	1/2	9/16 - 18UNF- LH	5.44	2.36	15,000
	12	12.7		138.0	60.0	103.5
1Y25X-12-08C-M-Subsea	-08	1/2	3/4 - 16UNF- LH	5.51	2.44	15,000
	12	12.7		140.0	62.0	103.5

2640M (V30)

Chapter C**BOP and hot-line hoses**

Textile reinforced hoses and related fittings	C-2
573LH – Low volumetric expansion BOP hose	C-2
575LH – Low volumetric expansion BOP hose	C-2
575X – Low volumetric expansion BOP hose	C-2
H580N – Low volumetric expansion BOP hose	C-2
Wire reinforced hoses and related fittings.....	C-4
2390N – polyflex [®] hot-line hose.....	C-4

573LH, 575LH, 575X, H580N – Low volumetric expansion BOP hose



MAIN FEATURES

- 573LH, Proof Test 4,500 psi, Impulse Requirements Minimum 200,000 cycles at 3,750 psi per SAE J343d
- 575LH Proof Test 7,500 psi, Impulse Requirements Minimum 200,000 cycles at 6,650 psi per SAE J343d

APPLICATIONS







- High pressure service for use with petroleum or synthetic hydraulic fluids for BOP umbilical applications where low volumetric expansion is required.

CONSTRUCTION

- Core tube** : Polyamide
Pressure reinforcement : One or two braided layers of high tensile aramid fibres
- Cover** : Special polyurethane
Colour : Black

TEMPERATURE RANGE

- 40°C up to +100°C for petroleum and synthetic hydraulic fluids
 –40°F up to +212°F for petroleum and synthetic hydraulic fluids

#								Series
	size DN	inch mm	inch mm	psi MPa	psi MPa	inch mm	lbs/ft kg/m	
573LH-3	-03	3/16	0.35	3,000	12,000	1.50	0.036	LV
	5	4.8	8.9	20.7	82.8	38	0.05	
575LH-3	-03	3/16	0.38	5,000	20,000	1.50	0.043	LH
	5	4.8	9.7	34.5	138.0	38	0.06	
575X-16	-16	1	1.47	5,000	20,000	11.00	0.360	58H
	25	25.4	37.3	34.5	138.0	279	0.53	
H580N-16	-16	1	2.47	3,000	12,000	12.00	0.530	58H
	25	25.8	62.7	20.7	82.8	305	0.78	

NOTES

Change in length: max. ±2 % at working pressure.
 Additional technical information in chapter “J”.

106LV, 106LH, 10658H – JIC female swivel fitting

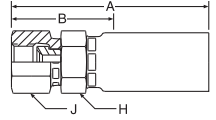

MATERIAL Stainless Steel (AISI 316)

#	⊙		⋈	A	B	J	↗
	size DN	inch mm					
106LV-4-3C	-04	1/4	7/16 - 20UNF	1.93 49.0	0.94 24.0	0.56 14	3,000 20.7
	6	6.4					
106LH-4-3C	-04	1/4	7/16 - 20UNF	1.93 49.0	0.94 24.0	0.56 14	5,000 34.5
	6	6.4					
10658H-16-16C	-16	1	1 5/16 - 12UNF	4.89 124.0	1.94 49.0	1.75 44	5,000 34.5
	25	25.4					

573LH

2390N – **polyflex**® hot-line hose



MAIN FEATURES

- Extremely Low Volumetric Expansion
- Low dimensional change under pressure
- Smooth bore for low pressure drop
- Offshore safety factor standard (4:1 SF)

APPLICATIONS

- Low volumetric expansion hose. Used for subsea hydraulic controls and as long length hot-line hose for BOP systems.









CONSTRUCTION

Core tube : Polyamide
Pressure reinforcement : High strength wire

Cover : Polyurethane
Colour : V12: blue, V13: green, V16: yellow

TEMPERATURE RANGE

SF 4:1: -40°C up to +100°C, max. 70°C for water or methanol based fluids.
SF 2.5:1: -40°C up to +60°C (-40°F up to +140°F)

#																
	size DN	inch mm	inch mm	psi * MPa	psi ** MPa	psi MPa	inch mm	lbs/ft kg/m								
2390N-08V12	-08	1/2	0.83	9,570	6,020	24,080	7.87	0.36	9X							
	12	12.8	21.0	66.0	41.5	166.0	200.0	0.54								
2390N-08V13	-08	1/2	0.83	9,570	6,020	24,080	7.87	0.36	9X							
	12	12.8	21.0	66.0	41.5	166.0	200.0	0.54								
2390N-08V16	-08	1/2	0.83	9,570	6,020	24,080	7.87	0.36	9X							
	12	12.8	21.0	66.0	41.5	166.0	200.0	0.54								
2390N-16V12	-16	1	1.38	6,530	4,060	16,240	13.39	0.91	9X							
	25	25.0	35.1	45.0	28.0	112.0	340.0	1.35								
2390N-16V16	-16	1	1.38	6,530	4,060	16,240	13.39	0.91	9X							
	25	25.0	35.1	45.0	28.0	112.0	340.0	1.35								

NOTES

* Max. working pressure with 2.5:1 safety factor

** Max. working pressure with 4:1 safety factor

Additional technical information in chapter "J".

2390N

1069X – JIC female swivel fitting

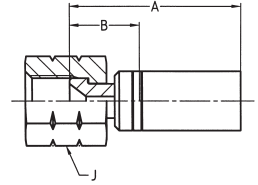

MATERIAL Stainless Steel (AISI 316)
*: Welded SubSea fitting

#	⊙		⋈	A	B	J	↻
	size DN	inch mm					
1069X-8-08C	-08	1/2	3/4 - 16UNF	2.52 64.0	0.83 21.0	1.063 27	9,570 66.0
	12	12.7					
E213JFC4*	-08	1/2	3/4 - 16UNF	3.35 85.0	1.61 41.0	0.945 24	9,570 66.0
	12	12.7					
1069X-16-16C	-16	1	1 5/16 - 12UNF	4.06 103.0	1.77 45.0	1.614 41	6,530 45.0
	25	25.4					
E225JIC3*	-16	1	1 5/16 - 12UNF	4.30 109.0	2.10 53.0	1.614 41	6,530 45.0
	25	25.4					

2390N

1929X – BSP female swivel fitting

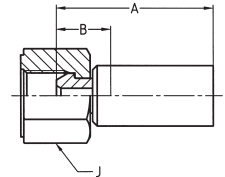

MATERIAL Stainless Steel (AISI 316)

#	⊙		⋈	A	B	J	↻
	size DN	inch mm					
1929X-8-8C	-08	1/2	G 1/2	2.48 63.0	0.79 20.0	1.06 27	9,570 66.0
	12	12.7					
1929X-16-16C	-16	1	G 1	3.46 88.0	1.06 27.0	1.61 41	6,530 45.0
	25	25.4					

1C99X – Metric swivel fitting with O-ring Heavy series

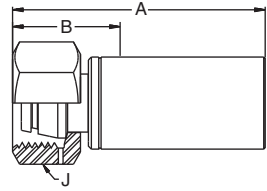

MATERIAL Stainless Steel (AISI 316)

#	⊙		~~~~~	A	B	J	↗
	size DN	inch mm					
1C99X-16-8C	-08	1/2	M24 x 1.5	3.07	1.38	1.18	9,570
	12	12.7		78.0	35.0	30	66.0
1C99X-30-16C	-16	1	M42 x 2	3.86	1.85	1.97	6,530
	25	25.4		98.0	47.0	50	45.0

1AY9X/6AY9X – Type "M" female swivel fitting

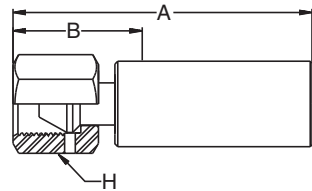

MATERIAL Stainless Steel (AISI 316)

#	⊙		~~~~~	A	B	J	↗
	size DN	inch mm					
6AY9X-11-8C	-08	1/2	1 - 12UNF	3.19	1.50	1.26	9,570
	12	12.7		81.0	38.0	32	66.0
6AY9X-16-16C	-16	1	1 5/16 - 12UNF	3.78	1.65	1.50	6,530
	25	25.4		96.0	42.0	38	45.0

Chapter D**High pressure hydraulic control and testing**

Textile reinforced hoses and related fittings	D-2
520N – Standard hydraulic hose	D-2
Wire reinforced hoses and related fittings.....	D-5
2380N – <i>polyflex</i>[®] hose	D-5
2440N – <i>polyflex</i>[®] hose	D-8

520N – Standard hydraulic hose









MAIN FEATURES • Not for use with chlorinated solvents.

APPLICATIONS Medium pressure hydraulic, pneumatic and lubricating oils including medium pressure tools, rigging jacks, test apparatus, oilfield pressure control devices and offshore oil applications.

CONSTRUCTION Core tube : Polyamide
 Pressure reinforcement : High tensile aramid fibres
 Cover : Polyurethane, pinpricked
 Colour : Black

TEMPERATURE RANGE -40°C up to +100°C, max. 70°C for water or methanol based fluids.
 -40°F up to +212°F, max. 158°F for water or methanol based fluids.

#														
	size DN	inch mm	inch mm	psi MPa	psi MPa	inch mm	lbs/ft kg/m							
520N-3	-03	3/16	0.42	5,000	20,000	1.50	0.050							55
	5	4.8	10.7	34.5	138.0	38	0.07							
520N-4	-04	1/4	0.50	5,000	20,000	2.00	0.066							55
	6	6.4	12.7	34.5	138.0	51	0.10							
520N-5	-05	5/16	0.57	4,500	18,000	2.50	0.080							55
	8	7.9	14.4	31.0	124.0	64	0.12							
520N-6	-06	3/8	0.64	4,000	16,000	2.50	0.084							55
	10	9.5	16.1	27.5	110.0	64	0.13							
520N-8	-08	1/2	0.81	3,500	14,000	4.00	0.135							55
	12	12.7	20.4	24.0	96.0	102	0.20							

NOTES For non pinpricked alternative use 528N hose (orange cover). Same dimensions, pressures and fittings.
 Additional technical information in chapter “J”.

10155 – NPT male - 60° cone

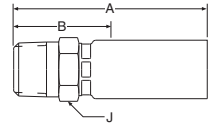

MATERIAL Stainless steel (AISI 316), other materials on request.

#	⊙		⌚	A	B	J	⌚
	size DN	inch mm					
10155-4-3C	-04	1/4	1/4 - 18NPTF	2.16	1.18	0.67	5,000
	6	6.4		55.0	30.0	17	34.5
10155-4-4C	-04	1/4	1/4 - 18NPTF	2.44	1.18	0.67	5,000
	6	6.4		62.0	30.0	17	34.5
10155-4-5C	-05	5/16	1/4 - 18NPTF	2.37	1.19	0.67	5,000
	8	7.9		60.0	30.0	17	34.5
10155-6-5C	-05	5/16	3/8 - 18NPTF	2.47	1.31	0.75	5,000
	8	7.9		63.0	33.0	19	34.5
10155-6-6C	-06	3/8	3/8 - 18NPTF	2.76	1.30	0.75	4,000
	10	9.5		70.0	33.0	19	27.5
10155-8-8C	-08	1/2	1/2 - 14NPTF	3.03	1.42	1.06	3,500
	12	12.7		77.0	36.0	27	24.0

520N

10655 – JIC female swivel fitting

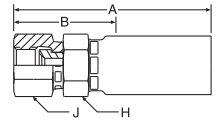

MATERIAL Stainless steel (AISI 316), other materials on request.

#	⊙		⌚	A	B	H	J	⌚
	size DN	inch mm						
10655-4-3C	-03	3/16	7/16 - 20UNF	2.17	1.18	0.63	0.67	5,000
	5	4.8		55.0	30.0	16	17	34.5
10655-4-4C	-04	1/4	7/16 - 20UNF	2.56	1.30	0.67	0.67	5,000
	6	6.4		65.0	33.0	17	17	34.5
10655-5-5C	-05	5/16	1/2 - 20UNF	2.50	1.38	0.67	0.75	5,000
	8	7.9		64.0	35.0	17	19	34.5
10655-6-5C	-05	5/16	9/16 - 18UNF	2.50	1.38	0.75	0.75	5,000
	8	7.9		64.0	35.0	19	19	34.5
10655-6-6C	-06	3/8	9/16 - 18UNF	2.72	1.30	0.75	0.75	4,000
	10	9.5		69.0	33.0	19	19	27.5
10655-8-8C	-08	1/2	3/4 - 16UNF	3.11	1.54	0.87	0.87	3,500
	12	12.7		79.0	38.0	22	22	24.0

19255 – BSP female swivel fitting

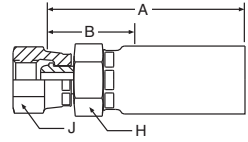

MATERIAL Stainless steel (AISI 316), other materials on request.

#	⊙		~~~~~	A	B	H	J	↗
	size DN	inch mm						
19255-4-3C	-03	3/16	G 1/4	2.09	1.10	0.67	0.75	5,000
	5	4.8		53.0	28.0	17	19	34.5
19255-4-4C	-04	1/4	G 1/4	2.28	1.02	0.67	0.75	5,000
	6	6.4		58.0	26.0	17	19	34.5
19255-6-5C	-05	5/16	G 3/8	2.36	1.06	0.75	0.87	5,000
	8	7.9		60.0	27.0	19	22	34.5
19255-6-6C	-06	3/8	G 3/8	2.52	1.06	0.75	0.87	4,000
	10	9.5		64.0	27.0	19	22	27.5
19255-8-8C	-08	1/2	G 5/8	2.87	1.26	0.94	1.06	3,500
	12	12.7		73.0	32.0	24	27	24.0

1C955 – Metric swivel with O-Ring Heavy series

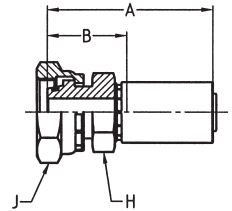

MATERIAL Stainless steel (AISI 316), other materials on request.

#	⊙		~~~~~	A	B	H	J	↗
	size DN	inch mm						
1C955-10-4C	-04	1/4	M18x1.5	2.64	1.42	0.87	0.87	5,000
	6	6.4		67.0	36.0	19	22	34.5
1C955-12-5C	-05	5/16	M20x1.5	2.44	1.18	0.94	0.94	5,000
	8	7.9		62.0	30.0	24	24	34.5
1C955-12-6C	-06	3/8	M20x1.5	2.68	1.26	0.87	0.94	4,000
	10	9.5		68.0	32.0	19	24	27.5
1C955-16-8C	-08	1/2	M24x1.5	3.03	1.42	0.94	1.18	3,500
	12	12.7		77.0	36.0	24	30	24.0

2380N – polyflex® hose**MAIN FEATURES**

- Extremely Low Volumetric Expansion.
- Low dimensional change under pressure.
- Smooth bore for low pressure drop.

APPLICATIONS

Small diameter, low volumetric expansion hose. Replaces high pressure rigid tubing where vibration and routing constraints are an issue. Used also for hydraulic controls, test systems with synthetic and phosphate ester fluids.

CONSTRUCTION

Core tube : Polyamide
Pressure reinforcement : High strength wire
Cover : Polyurethane
Colour : V10: black, V02: blue, V04: red

TEMPERATURE RANGE

SF 4:1: -40°C up to +100°C, max. 70°C for water or methanol based fluids.
 SF 2.5:1: -40°C up to +60°C (-40°F up to +140°F)

#														
	size DN	inch mm	inch mm	psi * MPa	psi ** MPa	psi MPa	inch mm	lbs/ft kg/m						
2380N-04V00	-04	1/4	0.52	16,000	10,150	40,600	2.76	0.18	LX, 8X					
	6	6.3	13.3	110.0	70.0	280.0	70	0.27						
2380N-04V02	-04	1/4	0.52	16,000	10,150	40,600	2.76	0.18	LX, 8X					
	6	6.3	13.3	110.0	70.0	280.0	70	0.27						
2380N-04V04	-04	1/4	0.52	16,000	10,150	40,600	2.76	0.18	LX, 8X					
	6	6.3	13.3	110.0	70.0	280.0	70	0.27						
2380N-06V10	-06	3/8	0.72	13,300	8,340	33,400	7.10	0.22	8X					
	10	9.7	18.4	92.0	57.5	230.0	180	0.33						
2380N-08V10	-08	1/2	0.90	12,800	7,500	30,000	5.91	0.46	8X					
	12	12.9	22.9	88.0	51.7	207.0	150	0.68						

NOTES

* Max. working pressure with 2.5:1 safety factor

** Max. working pressure with 4:1 safety factor

Additional technical information in chapter "J".

1018X – NPT male

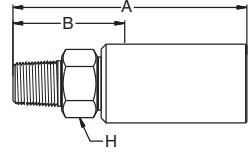

MATERIAL Stainless steel (AISI 316), other materials on request.

#	⊙		⌚	A	B	H	↻
	size DN	inch mm					
1018X-4-04C	-04	1/4	1/4" NPT	2.36	1.10	0.63	16,000
	6	6.4		60.0	28.0	16	110.0
1018X-6-05C	-05	5/16	3/8" NPT	2.95	1.34	0.75	13,600
	8	7.9		75.0	34.0	19	93.8
1018X-6-06C	-06	3/8	3/8" NPT	2.80	1.22	0.75	13,300
	10	9.5		71.0	31.0	19	93.0
1018X-8-08C	-08	1/2	1/2" NPT	3.11	1.42	0.87	12,800
	12	12.7		79.0	36.0	22	88.0

1068X – JIC female swivel fitting

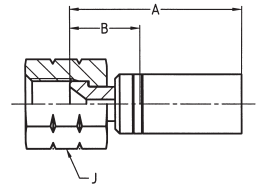

MATERIAL Stainless steel (AISI 316), other materials on request.

#	⊙		⌚	A	B	J	↻
	size DN	inch mm					
1068X-4-04C	-04	1/4	7/16 - 20UNF	2.24	0.98	0.63	16,000
	6	6.4		57.0	25.0	16	110.0
1068X-6-04C	-04	1/4	9/16 - 18UNF	2.36	1.10	0.67	16,000
	6	6.4		60.0	28.0	17	110.0
1068X-6-05C	-05	5/16	9/16 - 18UNF	2.72	1.10	0.75	13,600
	8	7.9		69.0	28.0	19	93.8
1068X-8-06C	-06	3/8	3/4 - 16UNF	2.32	0.75	0.94	13,300
	10	9.5		59.0	19.0	24	92.0
1068X-10-08C	-08	1/2	7/8 - 14UNF	2.48	0.75	1.06	12,800
	12	12.7		63.0	19.0	27	88.0

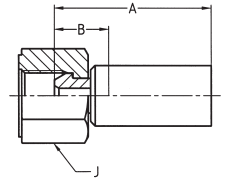
1928X – BSP female swivel fitting

MATERIAL Stainless steel (AISI 316), other materials on request.

#	⊙		⋈	A	B	J	↻
	size DN	inch mm					
1928X-4-04C	-04	1/4	G 1/4	2.20	0.98	0.75	16,000
	6	6.4		56.0	25.0	19	110.0
1928X-6-06C	-06	3/8	G 3/8	2.32	0.75	0.87	13,300
	10	9.5		59.0	19.0	22	92.0
1928X-8-08C	-08	1/2	G 1/2	2.48	0.79	1.06	12,800
	12	12.7		63.0	20.0	27	88.0

2380N

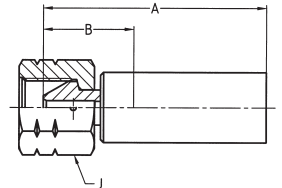
**1AY8X/6AYLX – 59° sealing cone
UNF swivel nut**

MATERIAL Stainless steel (AISI 316), other materials on request.

*: Nipple made from high corrosion resistant steel, nut and shell stainless steel (AISI 316).

#	⊙		⋈	A	B	J	↻
	size DN	inch mm					
1AY8X-6-04C	-04	1/4	9/16 - 18UNF	2.68	1.38	0.67	16,000
	6	6.4		68.0	35.0	17	110.0
6AYLX-6-4C-SD*	-04	1/4	9/16 - 18UNF	2.56	1.30	0.75	16,000
	6	6.4		65.0	33.0	19	110.0
6AYLX-8-5C	-04	1/4	3/4 - 16UNF	2.95	1.26	0.98	13,600
	6	6.4		75.0	32.0	25	93.8

2440N – *polyflex*® hose



MAIN FEATURES

- Extremely Low Volumetric Expansion.
- Low dimensional change under pressure.
- Smooth bore for low pressure drop.

APPLICATIONS

High pressure, low volumetric expansion hose. Flexible, chemical resistance, and lightweight alternative to steel pipe and rubber hose for applications such as chemical injection, gas transfer, wire-logging services and pressure testing.

CONSTRUCTION

Core tube : Polyamide
Pressure reinforcement : High strength wire

Cover : Polyamide
Colour : Grey

TEMPERATURE RANGE

-40°C up to +60°C
 -40°F up to +140°F

#								
	size DN	inch mm						
2440N-04V37	-04	1/4	0.51	20,300	50,800	6.10	0.21	LX
	6	6.3	13.0	140.0	350.0	155	0.31	
2440N-06V37	-06	3/8	0.76	20,300	50,800	7.50	0.50	LX
	10	9.7	19.4	140.0	350.0	190	0.74	
2440N-08V37	-08	1/2	0.89	18,850	47,125	7.90	0.64	LX
	12	12.8	22.5	130.0	325.0	200	0.94	
2440N-12V37	-12	3/4	1.18	14,500	36,250	9.80	0.99	LX
	20	19.6	30.0	100.0	250.0	250	1.47	
2440N-16V37	-16	1	1.47	13,050	32,650	11.80	1.34	LX
	25	25.0	37.4	90.0	225.0	300	2.00	

NOTES

* Max. working pressure with 2.5:1 safety factor
 Additional technical information in chapter "J".

106LX/606LX – JIC female swivel fitting

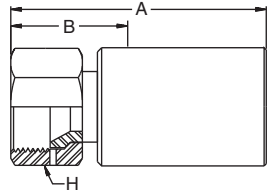

MATERIAL Stainless steel (AISI 316), other materials on request.
Nipple made from high strength stainless steel.

#	⊙		⌚	A	B	⬡	↻
	size DN	inch mm					
106LX-6-04C	-04	1/4	9/16 - 18UNF	2.17	0.91	0.75	12,500
	6	6.4		55.0	23.0	19	
106LX-6-06C	-06	3/8	9/16 - 18UNF	2.32	0.71	0.87	10,000
	10	9.5		59.0	18.0	22	
106LX-8-06C	-06	3/8	3/4 - 16UNF	2.32	0.75	0.94	12,500
	10	9.5		59.0	19.0	24	
106LX-8-08C	-08	1/2	3/4 - 16UNF	2.52	0.83	1.06	10,000
	12	12.7		64.0	21.0	27	
606LX-16-12C*	-12	3/4	1 5/16 - 12UNF	4.29	1.69	1.50	10,000
	20	19.0		109.0	43.0	38	
606LX-16-16C*	-16	1	1 5/16 - 12UNF	3.78	1.65	1.50	10,000
	25	25.4		96.0	42.0	38	

2440N

1C9LX/606LX – Metric swivel with O-ring Heavy series

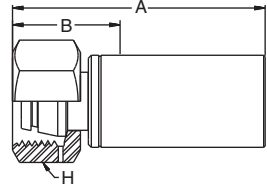

MATERIAL Stainless steel (AISI 316), other materials on request.
Nipple made from high strength stainless steel.

#	⊙		~~~~~	A	B	H	↻
	size DN	inch mm					
1C9LX-10-04C	-04	1/4	M18 x 1.5	2.76	1.30	0.87	20,300
	6	6.4		70.0	33.0	22	140.0
1C9LX-14-06C	-06	3/8	M22 x 1.5	2.99	1.18	1.18	12,500
	10	9.5		76.0	30.0	30	86.5
1C9LX-16-08C	-08	1/2	M24 x 1.5	3.46	1.34	1.26	11,700
	12	12.7		88.0	34.0	32	81.0
6C9LX-25-12C*	-12	3/4	M36 x 2	4.25	1.57	1.81	15,000
	20	19.0		108.0	40.0	46	103.5
6C9LX-30-16C*	-16	1	M42 x 2	5.47	1.77	2.17	13,050
	25	25.4		139.0	45.0	55	90.0

2440N

6AYLX – Type “M” female swivel fitting

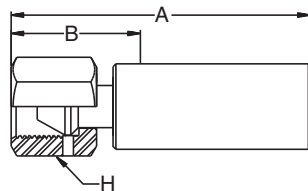

MATERIAL Nipple made from high strength stainless steel, nut and shell stainless steel (AISI316), other materials on request.
*: Nipple made from high corrosion resistant steel, nut and shell stainless steel (AISI 316).

#	⊙		⌚	A	B	⬡	↻
	size DN	inch mm					
6AYLX-6-4C	-04	1/4	9/16 - 18UNF	2.68 68.0	1.38 35.0	0.67 17	20,300 140.0
	6	6.4					
6AYLX-6-4C-SD*	-04	1/4	9/16 - 18UNF	2.68 68.0	1.38 35.0	0.67 17	20,300 140.0
	6	6.4					
6AYLX-8-6C	-06	3/8	3/4 - 16UNF	2.95 75.0	1.26 32.0	0.98 25	20,300 140.0
	10	9.5					
6AYLX-11-8C	-08	1/2	1 - 12UNF	3.54 90.0	1.50 38.0	1.26 32	18,850 130.0
	12	12.7					
6AYLX-11-8C-SD*	-08	1/2	1 - 12UNF	3.54 90.0	1.50 38.0	1.26 32	18,850 130.0
	12	12.7					
6AYLX-16-12C	-12	3/4	1 5/16 - 12UNF	4.13 105.0	1.54 39.0	1.50 38	14,500 100.0
	20	19.0					
6AYLX-16-12C-SD*	-12	3/4	1 5/16 - 12UNF	4.29 109.0	1.65 42.0	1.50 38	14,500 100.0
	20	19.0					
6AYLX-16-16C	-16	1	1 5/16 - 12UNF	5.47 139.0	2.05 52.0	1.50 38	13,050 90.0
	25	25.4					
6AYLX-16-16C-SD*	-16	1	1 5/16 - 12UNF	5.47 139.0	2.05 52.0	1.50 38	13,050 90.0
	25	25.4					

Chapter E

Large bore hoses for use in well services

Introduction **Black Eagle** family..... E-2

2440N (V80) – **polyflex**® hose **PHalcon** with ColorGard E-5

2448N (V80) – **polyflex**® hose **PHalcon** with ColorGard E-5

2640N (V80) – **polyflex**® hose **Black Eagle** with ColorGard E-8

2580N (V80) – **polyflex**® hose **Black Eagle** with ColorGard E-8

2640M (V80) – **polyflex**® hose **Golden Eagle** with ColorGard..... E-11

2580M (V80) – **polyflex**® hose **Golden Eagle** with ColorGard..... E-11

2448M (V80) – **polyflex**® hose **Golden Eagle** with ColorGard..... E-11

Large bore hoses

BLACK EAGLE family is a range of multispiral wire reinforced hoses specifically designed for the oil and gas market, with applications in offshore projects and land operations.

For many years this range of hoses has enabled our customers to optimize well production. Performing operations such as Acidizing, Cementing, Methanol Injection, Well Stimulation and Control Fluids.

Recently involved in light weight intervention (LWI) applications for offshore projects. These rigless operations are normally carried out from dynamically positioned intervention vessels to perform the following operations:

- Logging and re-perforating flow intervals through Wireline services
- Downhole mechanical works to reduce flow restrictions with deployment of slick line.
- Install / manipulate various mechanical devices (gas lift valves, plugs, screens etc.)
- Replace old Downhole subsea pump
- Chemical injection to avoid scale production
- Well abandonment and decommissioning

Project management

Our team has worked together with customers to develop skid mounted systems, for easier operation on multipurpose support vessels.





1. Features

- Working pressure from 34.5 MPa (5,000 psi) up to 103.5 MPa (15,000 psi)
- COLORGARD, dual colour safety feature with extra thick cover for superior abrasion resistance
- Long continuous lengths, no splicing – up to 2,000 m (6,500 ft)
- Polyamide-11 core tube for cleanliness
- Temperature up to 70 °C (158 °F)
- Weight up to 9.2 kg/m (6 lb/ft)
- Smaller OD than flexible pipe allows more hose per reel.
- Excellent chemical resistance providing long service life

2. Benefits

- Reduction the cost in maintenance and labour dedicated to oilfield operations
- Eliminates the jointing and potential for leakage avoiding spills and environmental damage
- Faster connections with less connections
- Safer field operations and less risk to personnel in pressure management
- A single length can be deployed in offshore operations, faster and safer with less connections and less risk to personnel.

Introduction

3. Construction Method

Polyflex hoses are designed regarding operating conditions, the criteria includes the following considerations:

- Compositions of fluids
- Temperatures and pressures
- Short-term fluctuations
- Static and dynamic loads

Thermoplastic Core tube: The inner tube is exposed to different fluids, the selection of the thermoplastic material reflect fluid compatibility, material strength and crack resistance.

It combines high ductility, excellent ageing properties and high barrier properties with mechanical strength and resistance to creep and fatigue

Wire spiral technology: Reinforcement with high tensile steel wire, is required to meet the industry requirements for low volumetric expansion, higher working pressures and higher collapse resistance

External Cover: The outer cover material offers excellent chemical, ozone and microbiological resistance.

Cover colour guard: For extreme conditions, additional protection can be added by specifying the ColorGard™ extra thick sheath safety feature. The ColorGard™ Concept – adds visibility to hose safety.

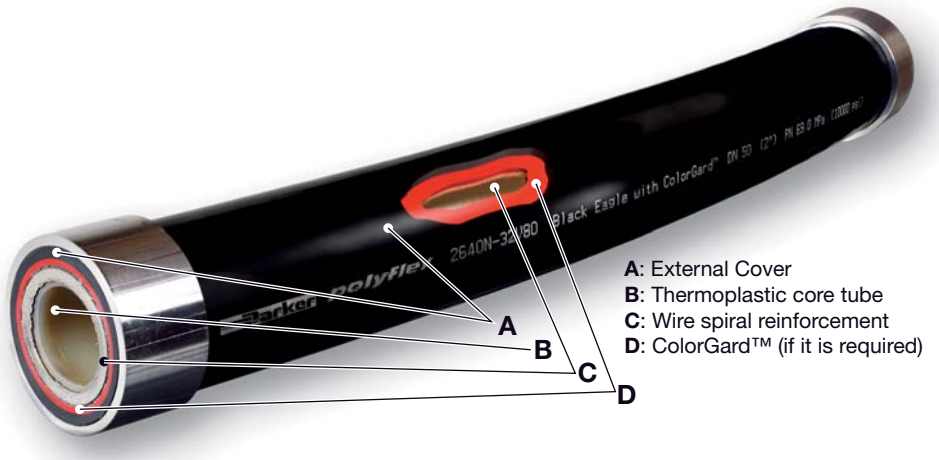

- A: External Cover
- B: Thermoplastic core tube
- C: Wire spiral reinforcement
- D: ColorGard™ (if it is required)

2440N / 2448N – *polyflex*[®] hose *Phalcon* + ColorGard[®]



MAIN FEATURES

- COLORGARD, dual colour safety feature with extra thick cover for superior abrasion resistance.
- Polyamide-11 core tube for cleanliness.
- Weight up to 7 kg/m.
- Smaller OD than flexible pipe allows more hose per reel.
- Excellent chemical resistance providing long service life in sea water.

APPLICATIONS

Used for high volume pumping in well service applications such as chemical injection and other onshore and subsea well stimulation operations. Available in long continuous lengths.







CONSTRUCTION

Core tube : PA11
Pressure reinforcement : High strength wire

Cover : Extra thick polyurethane cover
Colour : ColorGard[®] safety feature (red inner, black outer cover)

TEMPERATURE RANGE

-40°C up to +70°C,
-40°F up to +158°F

#								
	size DN	inch mm	inch mm	psi MPa	psi MPa	inch mm	lbs/ft kg/m	
2440N-16V80	-16	1	1.77	7,500	30,000	11.80	2.02	*
	25	26.0	45.0	51.7	207.0	300.0	3.00	
2440N-24V80	-24	1 1/2	2.56	5,000	20,000	17.70	2.82	*
	40	38.0	65.0	34.5	138.0	450.0	4.20	
2448N-32V80	-32	2	3.23	5,000	20,000	19.70	4.70	BL
	50	50.5	82.0	34.5	138.0	500.0	7.00	

 product under development

*: consult factory

NOTES

Additional technical information in chapter "J".

Large bore hoses for use in well services

Wire reinforced hoses

101BL – NPT male fitting

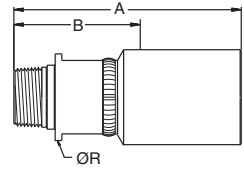

MATERIAL Nipple zinc plated high strength special steel, shell stainless steel (AISI 316), other materials on request.

#	⊙		~~~~~	A	B	ØR	↻
	size DN	inch mm		inch mm	inch mm	inch mm	
101BL-32-32	-50 50	2 50.8	2" - NPT	10.51 267.0	4.09 104.0	3.27 83.0	10,000 69.0

1C95X – Metric swivel fitting with O-ring

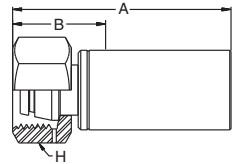

MATERIAL Stainless steel (AISI 316), other materials on request.

#	⊙		~~~~~	A	B	H	↻
	size DN	inch mm		inch mm	inch mm	inch mm	
1C95X-38-24COSK-TC	-24 40	1 1/2 38.0	M52 x 2	5.63 143.0	1.97 50.0	2.56 65	15,000 103.5

1HNBL – Hammerlug union female

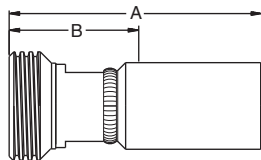

MATERIAL Nipple zinc plated high strength special steel, shell stainless steel (AISI 316), other materials on request.

#	⊙		~~~~~	A	B	↻
	size DN	inch mm				
1HNBL-32-32	-50 50	2 50.8	4 1/8"-3 ACME	11.26 286.0	5.87 149.0	10,000 69.0

1HEBL – Hammerlug union male

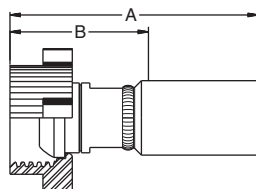

MATERIAL Nipple zinc plated high strength special steel, shell stainless steel (AISI 316), other materials on request.

#	⊙		~~~~~	A	B	↻
	size DN	inch mm				
1HEBL-32-32	-50 50	2 50.8	4 1/8"-3 ACME	9.49 241.0	4.13 105.0	10,000 69.0

Large bore hoses for use in well services

Wire reinforced hoses

2640N / 2580N – polyflex® hose
Black Eagle family + ColorGard®



MAIN FEATURES

- COLORGARD, dual colour safety feature with extra thick cover for superior abrasion resistance.
- Polyamide-11 core tube for cleanliness.
- Weight up to 27.5 kg/m.
- Smaller OD than flexible pipe allows more hose per reel.
- Excellent chemical resistance providing long service life in sea water.

APPLICATIONS

Flexible, lightweight, chemical resistant alternative to steel or flexible pipe.
 Used for high volume pumping in well service applications such as cementing chemical injection and other onshore and subsea well stimulation operations. Available in long continuous lengths (500 m to 2,000 m depending on size).







CONSTRUCTION

Core tube : PA11
Pressure reinforcement : High strength wire

Cover : Extra thick polyurethane cover
Colour : ColorGard® safety feature (red inner, black outer cover)

TEMPERATURE RANGE

-40°C up to +70°C,
 -40°F up to +158°F

#								
	size DN	inch mm	inch mm	psi MPa	psi MPa	inch mm	lbs/ft kg/m	
2640N-16V80	-16	1	1.57	15,000*	43,500	15.80	1.95	HX
	25	26.0	40.0	103.5*	300.0	400	2.90	
2640N-24V80	-24	1 1/2	2.76	10,000*	33,350	19.70	4.84	5X
	40	38.0	70.0	69.0*	230.0	500	7.20	
2580N-32V80**	-32	2	3.33	10,000*	25,000	31.50	6.18	BL
	50	50.5	84.5	69.0*	172.5	800	9.20	
2640N-48V80	-48	3	5.12	10,000*	33,750	47.20	18.48	5X
	78	76.0	130.0	69.0*	233.0	1200	27.50	

 product under development

NOTES

* Max. working pressure with safety factor less than 4:1.

** 2580N-32V80 is a replacement for 2640N-32V80.

Additional technical information in chapter “J”.

Black Eagle

6015X/101BL – NPT Male fitting

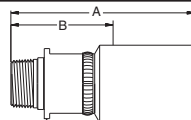

MATERIAL Nipple zinc plated high strength special steel, shell stainless steel (AISI 316), other materials on request.

#	⊙		⌚	A	B	ØR	↻
	size DN	inch mm					
6015X-32-24-TC	-24	1 1/2	2" - NPT	9.09	4.21	3.35	10,000
	40	38.0		231.0	107.0	85.0	69.0
101BL-32-32	-32	2	2" - NPT	10.51	4.09	3.27	10,000
	50	50.5		267.0	104.0	83.0	69.0

6AYHX – Type “M” swivel female fitting

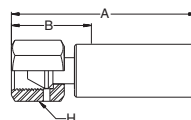

MATERIAL Consult factory

#	⊙		⌚	A	B	H	↻
	size DN	inch mm					
6AYHX-16-16C-TC	-16	1	1 5/16 - 12NPTF	4.76	2.17	1.97	15,000
	25	25.4		121.0	55.0	50	103.5

6C9HX/1C95X – Metric swivel fitting with O-ring

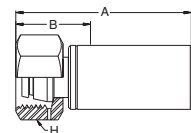

MATERIAL High strength stainless steel, other materials on request.

#	⊙		⌚	A	B	H	↻
	size DN	inch mm					
6C9HX-30-16C-TC	-16	1	M42 x 2	4.76	2.17	1.97	15,000
	25	25.4		121.0	55.0	50	103.5
1C95X-38-24COSK-TC	-24	1 1/2	M52 x 2	5.63	1.97	2.56	15,000
	40	38.0		143.0	50.0	65	103.5

Large bore hoses for use in well services

Wire reinforced hoses

6HN5X/1HNBL – Hammerlug union female

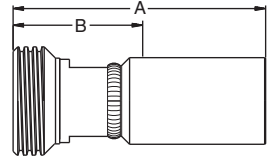

MATERIAL Nipple zinc plated high strength special steel, shell stainless steel (AISI 316), other materials on request.

#	⊙		~~~~~	A	B	↻
	size DN	inch mm				
6HN5X-32-24-TC	-24	1 1/2	4 1/8"-3 ACME	10.71	5.79	10,000
	40	38.1		272.0	147.0	
1HNBL-32-32	-32	2	4 1/8"-3 ACME	11.26	5.87	10,000
	50	50.8		286.0	149.0	

6HE5X/1HEBL – Hammerlug union male

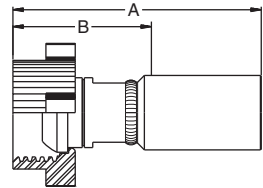

MATERIAL Nipple zinc plated high strength special steel, shell stainless steel (AISI 316), other materials on request.

#	⊙		~~~~~	A	B	↻
	size DN	inch mm				
6HE5X-32-24-TC	-24	1 1/2	4 1/8"-3 ACME	9.13	4.25	10,000
	40	38.1		232.0	108.0	
1HEBL-32-32	-32	2	4 1/8"-3 ACME	9.49	4.13	10,000
	50	50.8		241.0	105.0	

Black Eagle

2640M / 2580M / 2448M – **polyflex**[®] hose **Golden Eagle** family + ColorGard[®]



MAIN FEATURES

- COLORGARD, dual colour safety feature with extra thick cover for superior abrasion resistance.
- Fluoropolymer based.
- Weight up to 9.2 kg/m.
- Smaller OD than flexible pipe allows more hose per reel.
- Excellent chemical resistance providing long service life in sea water.

APPLICATIONS

Flexible, lightweight, chemical resistant alternative to steel or flexible pipe.
Used for high volume pumping in well service applications with acid fluids and chemical injection and other onshore and subsea well stimulation operations. Available in long continuous lengths (500 m to 2,000 m depending on size).

CONSTRUCTION

Core tube : Fluoropolymer based
Pressure reinforcement : High strength wire

Cover : Extra thick Polyurethane
Colour : ColorGard[®] safety feature (red inner, golden outer cover)

TEMPERATURE RANGE

-40°C up to +100°C, short term 125°C
-40°F up to +212°F, short term 257°F

#								
	size DN	inch mm	inch mm	psi MPa	psi MPa	inch mm	lbs/ft kg/m	
2640M-16V80	-16	1	1.57	10,000*	33,350	15.80	1.95	HX
	25	26.0	40.0	69.0*	230.0	400	2.90	
2640M-24V60**	-24	1 1/2	2.44	10,000*	33,350	19.70	4.30	5X
	40	38.0	62.0	69.0*	230.0	500	6.40	
2448M-32V80	-32	2	3.23	5,000	20,000	31.50	4.70	BL
	50	50.5	82.0	34.5	138.0	500	7.00	
2580M-32V80	-32	2	3.33	10,000*	25,000	31.50	6.18	BL
	50	50.5	84.5	69.0*	172.5	800	9.20	

product under development

NOTES

* Max. working pressure with safety factor less than 4:1.

** V60: black PVDF cover

Additional technical information in chapter "J".

Large bore hoses for use in well services

Wire reinforced hoses

6015X/101BL – NPT Male fitting

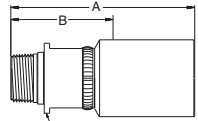

MATERIAL Nipple zinc plated high strength special steel, shell stainless steel (AISI 316), other materials on request.

#	⊙		~~~~~	A	B	ØR	↗
	size DN	inch mm					
6015X-32-24-TC	-24	1 1/2	2" - NPT	9.09	4.21	3.35	10,000
	40	38.0		231.0	107.0	85.0	69.0
101BL-32-32	-32	2	2" - NPT	10.51	4.09	3.27	10,000
	50	50.5		267.0	104.0	83.0	69.0

6AYHX – Type “M” swivel female fitting

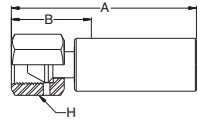

MATERIAL Stainless steel (AISI 316), other materials on request.

#	⊙		~~~~~	A	B	H	↗
	size DN	inch mm					
6AYHX-16-16C-TC	-16	1	1 5/16 - 12UNF	4.76	2.17	1.97	15,000
	25	25.4		121.0	55.0	50	103.5

6C9HX/1C95X – Metric swivel fitting with O-ring

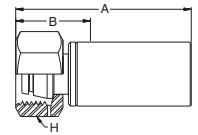

MATERIAL Stainless steel (AISI 316), other materials on request.

#	⊙		~~~~~	A	B	H	↗
	size DN	inch mm					
6C9HX-30-16C-TC	-16	1	M42 x 2	4.76	2.17	1.97	15,000
	25	25.4		121.0	55.0	50	103.5
1C95X-38-24COSK	-24	1 1/2	M52 x 2	5.63	1.97	2.56	15,000
	40	38.0		143.0	50.0	65	103.5

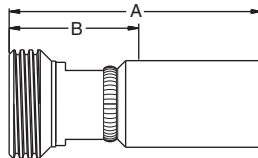
6HN5X/1HNBL – Hammerlug union female

MATERIAL Nipple zinc plated high strength special steel, shell stainless steel (AISI 316), other materials on request.

#	⊙		~~~~~	A	B	↻
	size DN	inch mm				
6HN5X-32-24-TC	-24	1 1/2	4 1/8"-3 ACME	10.71	5.79	10,000
	40	38.1		272.0	147.0	
1HNBL-32-32	-32	2	4 1/8"-3 ACME	11.26	5.87	10,000
	50	50.8		286.0	149.0	

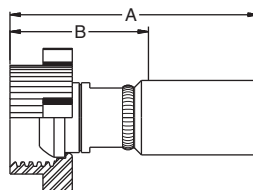
6HE5X/1HEBL – Hammerlug union male

MATERIAL Nipple zinc plated high strength special steel, shell stainless steel (AISI 316), other materials on request.

#	⊙		~~~~~	A	B	↻
	size DN	inch mm				
6HE5X-32-24-TC	-24	1 1/2	4 1/8"-3 ACME	9.13	4.25	10,000
	40	38.1		232.0	108.0	
1HEBL-32-32	-32	2	4 1/8"-3 ACME	9.49	4.13	10,000
	50	50.8		241.0	105.0	

Chapter F**Hose umbilicals**

Construction, applications, and manufacturing locations	F-2
Typical bundle configurations	F-5
Check list for hose bundle inquiries	F-8

Hose umbilicals

Construction, applications, and manufacturing locations



Polyflex series of umbilicals have been specially designed for the offshore industry to offer a unique combination of long life, high working pressures, chemical resistance, flexibility, lightweight, and rugged construction.



Customers can customize products with high resistant core tube capable to withstand aggressive fluids and gases often encountered in offshore applications.



The umbilicals systems are designed according to requirements of working pressure, this capability may be achieved by combining multiple layers of possible reinforcement material such as: aramid fibre and stainless steel braid.



The aramid fibre combines strength with low weight and results in excellent response times due to low volumetric expansion.



A wide variety of custom made umbilicals are available from **polyflex**[®] incorporating high pressure reinforced hoses, electric cables, fibre optics, tension members, and other features.



All components are helically wound for maximum flexibility and protected by a tough water and abrasion resistant outer jacket. Mechanical protection, such as armouring and stainless steel braiding can be added to improve kink resistance and external protection.



Applications include tool supply lines, flying leads, jumpers, electro/hydraulic workover, chemical injection, pipeline testing, lubrication and BOP controls.





FEATURES

- Withstands high pressure cycling tests (138 MPa, 20,000 psi) with no signs of stress cracking.
- Proven to handle methanol at 100 °C (212 °F) and 103.5 MPa (15,000 psi) working pressure
- Maintains a high percentage of minimum burst when tested at 125 °C
- Long continuous length up to 3,000 m (9,500 ft)
- Low volumetric expansion for fast response time
- High collapse resistance (HCR) and also providing longer service life
- Weather and ultra-high abrasion resistant. The hose is suitable for marine (salt water) environment.

BENEFITS

- As a system integrator in this market, Polyflex Division uses this technological advantage to innovate in breakthrough components and complete systems for customers.
- Customers can customize products with high resistant core tube capable to withstand aggressive fluids and gases often encountered in offshore applications.
- The compact design of Polyflex hoses reduces the umbilical OD thus increasing your reel capacity or use a smaller winch.

Hose umbilicals

Construction, applications, and manufacturing locations

Parker has four manufacturing locations for hose umbilicals:

Hüttenfeld, Germany

General applications, maximum length 2,000 m

Ravenna, Ohio USA

General application, specialises in BOP umbilicals

Cabett Subsea, located in Freeport & Houston Texas and

Scan Subsea, in Tonsberg, Norway

These dockside manufacturing facilities offer logistical advantages, allowing easy access to either the Gulf of Mexico or the North Sea by installation vessels.

Scan Subsea produces production control umbilicals, power cables and mooring line products that service the Oil & Gas and alternative energy markets.

Cabett is a leading provider of production control umbilicals in the Gulf of Mexico.



Parflex aramid reinforced hose (10,000 psi hose and lower) can be combined with **polyflex**[®] wire spiral reinforced hose (10,000 psi and above) in custom engineered umbilicals, also referred to as hose bundles.

Our technical staff will help design a product to meet your specifications and routing requirements. Strength members, tubing, electrical cables, pneumatic lines, and more can be combined with hose, inside of a protective jacket per your custom specifications.

Typical applications include offshore and land-based exploration and drilling operations, hydraulic tool supply lines, and many others.

polyflex[®] unique manufacturing process can produce very long lengths of steel reinforced thermoplastic hose with very low volumetric expansion characteristics.

High pressure, long lengths, light weight and fast response times are features that account for the success of **polyflex**[®] hose umbilicals.

Typical bundle configurations

Description:

1. Light weight Aramid reinforced hoses of 5,000 psi working pressure
2. Incorporated electrical cables
3. Wellhead testing umbilical, 850 meters continuous length

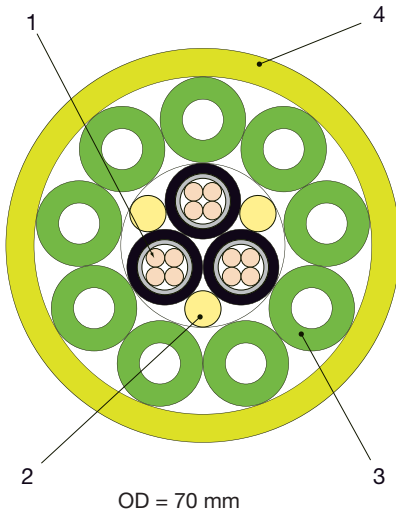

4	1x	PU cover, yellow
3	9x	Polyflex hose 2022N-04V91
2	3x	PA rope
1	3x	Electric cable

Description:

1. Light weight Aramid reinforced hoses of 5,000 psi working pressure
2. Incorporated electrical cable with SS wire as tensile strength member
3. Low pressure umbilical for hydraulic/ electrical power, 1,500 meters continuous length

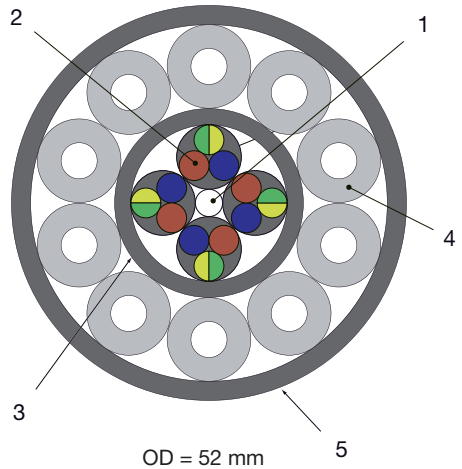

5	1x	Polyurethane sheath
4	10x	Hydraulic hose 550H-3
3	1x	Electric cable outer sheath – Polyurethane
2	4x	Electric cable RADOX 125, black, 3X0, 75 mm ² +SCR
1	1x	SSWire + plastic sheath

Typical bundle configurations

Hose umbilicals

Description:

1. Wire reinforced hoses of 15,000 psi working pressure
2. Hydraulic control umbilical, 400 meters continuous length

Description:

1. Wire reinforced hoses of 15,000 psi working pressure
2. Wellhead testing umbilical, 2,000 meters continuous length

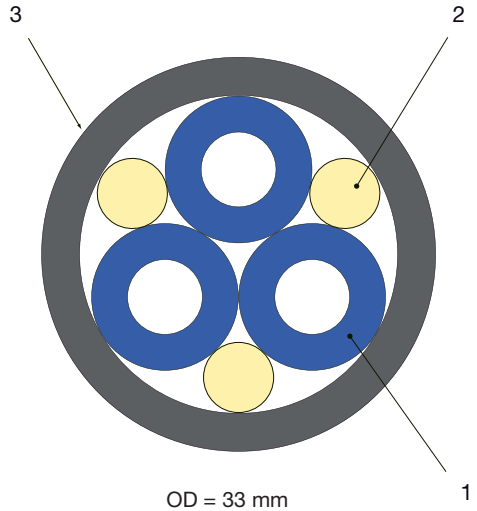
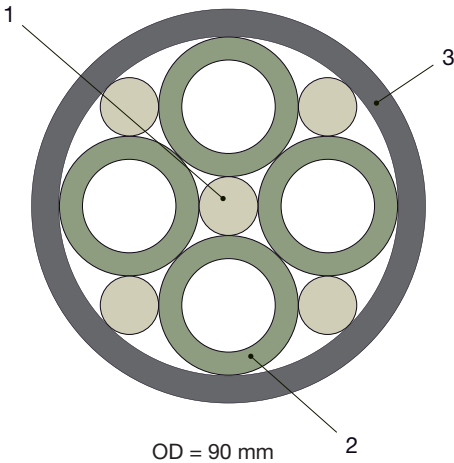

3	1x	TPU outer jacket
2	4x	Polyflex hose 2440N-12V91
1	5x	PA rope filler

3	1x	PUR outer jacket
2	3x	Filler
1	3x	High pressure hose 2440N-03V32

Description:

1. Wire reinforced hoses of 15,000 psi working pressure
2. Hydraulic control umbilical, 1,200 meters continuous length

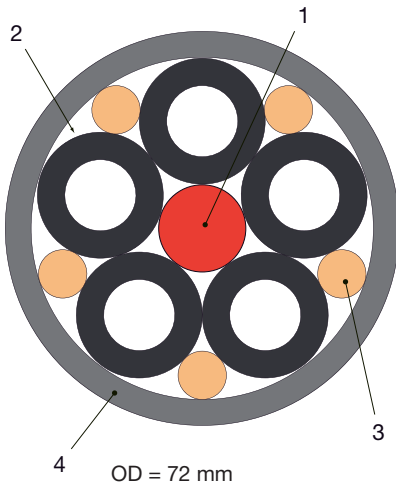

4	1x	TPU outer jacket
3	5x	Filler
2	5x	High pressure hose 2440N-08V91
1	1x	PA rope

Description:

1. Wire reinforced hoses of 15,000 psi working pressure
2. Choke and kill umbilical, 120 meters continuous length

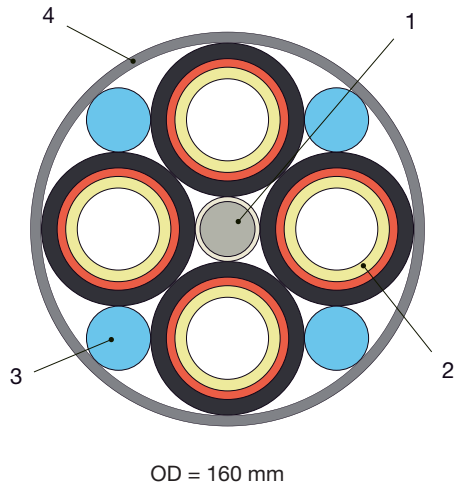

4	1x	TPU outer jacket
3	4x	PA rope filler
2	4x	Polyflex hose 2640N-24V80
1	1x	Steel rope, nylon coated (ca. 15 tons)

Check list for hose bundle inquiries

I. General Information

Although not all technical details are known in the early stage of a technical description or feasibility study, for budget offers the following information is absolutely necessary:

II. Technical data

1. Number and type of single hoses:

2. Working pressure:

3. Medium:

4. Total length of umbilical:

5. Water depth:

6. Operation conditions:

7. Minimum break load:

8. Requirements for the outer cover:

9. For conductors/cables:
Cross section:
Solid or stranded, screened or unscreened:
If possible electrical characteristics:

10. Fittings, type of material:

11. Termination of bundle:

Chapter G

High pressure connectors, adaptors and valves

High pressure..... G-2

National Pipe Tapered (NPT) G-3

Valves..... G-4

High pressure

Sizes

1/4" O.D. x 0.08" I.D. • 9/16" - 18 male thread on gland nut
3/8" O.D. x 0.12" I.D. • 3/4" - 16 male thread on gland nut
9/16" O.D. x 0.18" I.D. • 1 1/8" - 12 male thread on gland nut

Identification is by tubing O.D.

Construction

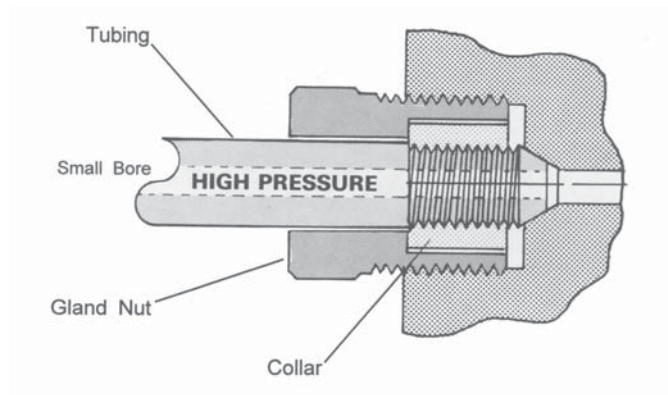

High Pressure is a 58/60 degree coned and threaded tubing design.

With small bore sizes, they have a maximum working pressure rating of 60,000 psi.

Advantages

- An industry standard for use at elevated pressures.
- Suitable for repetitive assembly and disassembly.

National Pipe Tapered (NPT)

Scope



polyflex™ offers a broad range of high quality stainless steel high pressure NPT adapters. Sizes 1/8" to 1/2" are rated up to 15,000 psi, 3/4" and above are rated to 10,000 psi.

Adapters

Valves

Medium Pressure — up to 20,000 psi

High Pressure — up to 60,000 psi

Scope

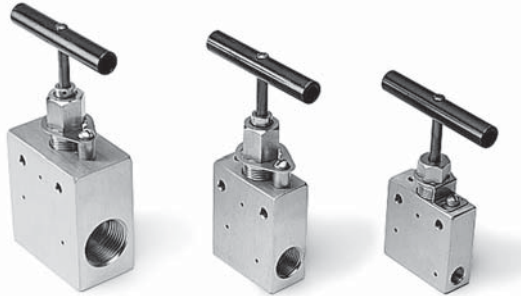

Developed to assure safe and easy plumbing through 60,000 psi. These needle valves are engineered to the highest standards of repeatable quality. The medium pressure valves are designed with a compact cone-and-threaded connection which permits the larger bore sizes and increased flow rates common in this pressure class. The high pressure valves also use a coned-and-threaded connection which accommodates the high pressures common in these applications.

Non-rotating tip stems are standard for on-off service and insure long life on valve seats.

Materials include high tensile type 316 stainless steel bodies and hardened 17-4PH stainless steel lower section stems.

Packing is TFE standard with optional Viton®, BUNA-N and Grafoil available as non-standard.

Two Way Straight valves are standard with five additional patterns to satisfy widely varied requirements are available on request.

Features

- Non-Rotating Stem Tips
- Packing Below Stem Threads
- Type 316 ss high tensile bodies
- Positive gland lock device
- No stem adjustment needed
- Black T-handles standard or choice of 4 colors (special order)
- Tube sizes

Medium Pressure — 1/4" through 1"

High Pressure — 1/4" through 9/16"

Chapter H

Quick couplers

Rogan series H-2

C Series hydraulic couplers H-3

Rogan series

Scope

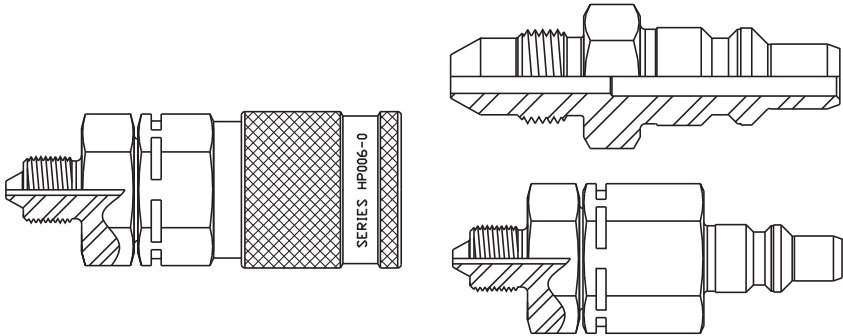

A versatile connecting device that permits easy and rapid joining of hose assemblies to your system. Each coupling is assembled and pressure tested to at least 5,000 psi above its maximum rated working pressure. Couplings with check-valve can withstand the full working pressure in the disconnected condition.

Types and pressures

Type	Max. working pressure (psi/MPa)	Test pressure (psi/MPa)	Nominal thru hole diameter (inch/mm)
HP006	30,000 / 206.8	35,000 / 241.3	0.24 / 6.1
HP010	20,000 / 137.9	25,000 / 172.4	0.40 / 10.2

NOTE: The choice of the threaded end form may limit the working pressure and the size of the thru hole in the coupling. Call **polyflex**™ for additional information.

C series

Applications

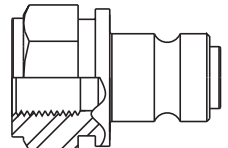
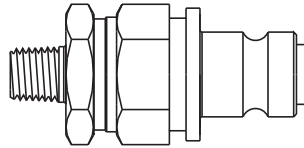
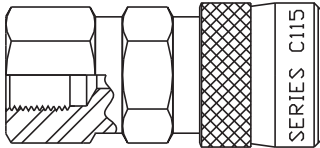

- Torque Tensioning
- Stud Tensioning
- Rescue
- Bearing Pullers
- Intensifiers
- Hydrostatic Testing
- Pumps
- Jacks
- Spreaders
- Cable Cutters
- Nut Splitters
- Pipe Coupling Swagers
- Presses
- Clamping Fictures
- Crimpers
- Blow-out Preventers

Features

- Working pressures to 29,000 psi.
- Non-drip valving for clean, safe, trouble-free performance and minimal air inclusion.
- Built-in safety locking device to prevent accidental disconnect.
- Wide range of threaded styles NPT, BSP and “High Pressure”.
- Adaptors for ease of connection to high pressure hoses and fixed ports.
- Thread sizes from 1/8" to 3/8"
- Protective dust caps are included to prevent damage and fluid contamination in disconnected position.
- Rugged design and construction for long life in demanding applications.

Types and pressures

Type	Max. working pressure (psi/MPa)	Test pressure (psi/MPa)	Nominal thru hole diameter (inch/mm)
C Series 115	14,500 / 100.0	21,800 / 150.3	0.11 / 2.8
C Series 116	21,800 / 150.3	29,200 / 201.3	0.11 / 2.8
C Series 125	29,800 / 205.5	36,300 / 250.3	0.11 / 2.8

NOTE: The choice of the threaded end form may limit the working pressure and the size of the thru hole in the coupling.

Chapter I

Accessories & tooling

Spring guards.....	I-2
Containment grips.....	I-2
Support grips	I-2
Anti-gall lubricant	I-2
Dies, HP fittings.....	I-3
Dies, HP guards	I-3
Gauges, HP fittings	I-3
Dies for polyflex [®] hose (2390N, 2245N, 57CR)	I-3
MiniKrimp, Parkrimp II and BSC-1	I-4

Spring guards



#	Description
MSG060	0.60" I.D. Continuous Spring
MSG1006	For 2040N-04V00 Hose
MSG2006	For 2245N-04V00 Hose
MSG2106	For 2380N-04v00 Hose
MSG4113	For -8 Hoses
MSG4120	For 2440n-12V37 Hose
MSG4125	For 2440N-16V37 Hose
MSG6020	For 2640N-12v32 Hose

Containment grips



#	Description
HS-03	Containment grip DN05, HS 10-15
HS-05	Containment grip DN08, HS 15-20
HS-08	Containment grip DN12, HS 20-30
HS-12	Containment grip DN20, HS 30-40
HS-16	Containment grip DN25, HS 40-50
HS-20	Containment grip DN32, HS 50-60
HS-28	Containment grip DN46, HS 60-70
HS-32	Containment grip DN50, HS 90-110

Support grips

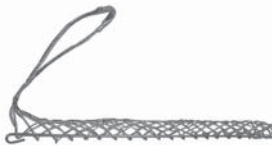

#	Description
MK022-03-038	For Hose O.D. 0.63" - 0.74"
MK022-03-039	For Hose O.D. 0.75" - 0.99"
MK022-03-041	For Hose O.D. 1.00" - 1.24"
MK022-03-042	For Hose O.D. 1.25" - 1.49"
MK022-03-043	For Hose O.D. 1.50" - 1.74"
MK022-03-045	For Hose O.D. 2.25" - 2.49"

ThreadMate™ Anti-gall lubricant



#	Description
MTM04T	4-oz Tube

- ThreadMate is an extreme duty lubricant developed to reduce galling during the assembly of threaded parts.
- ThreadMate promotes reliable sealing of pipe threads even at high pressure by reducing friction and galling during tightening, resulting in higher contact pressures of the sealing surfaces, and better metal-to-metal contact.
- ThreadMate reduces the torque needed to make pressure tight connections and tighten fasteners.

Dies, HP fittings



#	Description
80C-HP3	Dies for HP3 Fittings
80C-HP4	Dies for HP4 Fittings
80C-HP6	Dies for HP6 Fittings

Dies, HP guards



#	Description
80C-G03	Dies for HP3 Guards
80C-G04	Dies for HP4 Guards
80C-G06	Dies for HP6 Guards

Gauges, HP fittings



#	Description
HP-3-Gauge	Gauge for HP-3 Fittings
HP-4-Gauge	Gauge for HP-4 Fittings
HP-6-Gauge	Gauge for HP-6 Fittings

Dies for *polyflex* hose

- 2390N Hose series
- 2245N Hose series
- 57CR SeaWolf™



#	Description	Fitting series
83C-9X04	2390N-04	9x
83C-9X08	2390N-08	9X
83C-9X16	2390N-16	9X
80C-F04G	2245N-04V00	55
80C-F06G	2245N-06V00	58
80C-F08G	2245N-08V00	58
80C-F10G	2245N-10V30	58
80C-F12G	2245N-12V30	58
83C-F16G	2245N-16V30	58
83C-F08W	57CRN-08V	CR
83C-F16W	57CRN-16v	CR

MiniKrimp™



Standard Equipment

Model 94C-001-PFD includes:

#	Description
94C-080-PFD	MiniKrimp™ Portable Crimping Machine
015301	Hand Pump
82C-R01-PFD	Die Ring – Color Coded Silver

The MiniKrimp is a portable, one piece crimper for hose assemblies up to -20.

Due to it's light and very compact design the MiniKrimp is easy to transport and provides a cost effective way to make hose assemblies in the field.

The MiniKrimp is able to crimp the following fitting series:

55/56/57/58/91N and EH of the Polyflex division product range, 43/46/48 and 26 of the HPDE product range.

Optional Equipment

#	Description
015736	Side Vise Mount
015306	Upright Table Mount
015307	Upright Vise Mount
82C-R02-PFD	Die Ring – Color Coded Black
015309	Hose Assembly
015308	Replacement Tube Assembly w/o Fittings

Parkrimp II

Parkrimp II provides you with total capability to manufacture hydraulic hose assemblies up through 2". Parkrimp II's advanced design – with capacity to handle 100R1 through 100R14 hose types, coupled with straight or bent tube ends – is the industry's leading edge in the manufacture of hydraulic hose assemblies. Unparalleled in its design, Parkrimp II needs no special adjustments or gauge settings. Simply insert the unitized or split die train for the appropriate size – and with push button ease you have factory-quality assemblies in just seconds.



BSC-1

BSC-1 is a portable hydraulic crimping machine for one-off production of hose assemblies up to 45mm crimping diameter. Thanks to its lightness, the crimping machine suits especially well to traveling technicians and on-site service. It is operated with compressed air and comprises of a base, a crimping head and a power unit. The crimping machine is adjustable and not limited to use with a certain fitting series but can be used for all Polyflex fitting types. Dies are supplied in millimeter intervals.



#	Description
83C-081-PFD	For hose types 100R1 to 100R14

#	Description
BSC-1	for Polyflex hose fittings

Chapter J**Technical information**

Parker engineering manual (PFDE-ES 29):	
Technical matrix for Parker polyflex [®] offshore hoses	J-2
Parker engineering manual (PFDE-ES 28):	
Recommended practices for handling, maintenance and inspection of long length Parker polyflex [®] offshore hoses and hose assemblies	J-7
Chemical resistance for Nylon 11	J-10
General chemical resistance table	J-14
Pressure drop tables	J-18
Recommended tightening procedures.....	J-22
Test equipment for qualification testing and production control.....	J-23
Parker safety guide	J-27
Glossary	J-34

Consult Parker for more detailed information.

Parker engineering manual

Technical matrix for Parker polyflex offshore hoses

Parker Publication No. PFDE-ES29
Revised: June 2009

1 SCOPE

This engineering standard contains the main information which is important for selection of hose for most of the offshore applications.

Guidelines for handling and storage of hose see PFDE-ES28.

2 NOTES

Detailed information is available in appropriate hose specifications. They always have precedence.

Most of the hoses have been fully qualified acc. to ISO 13268-5 for the working pressures stated. Some at even higher pressures. Contact Parker for detailed information.

Working pressures stated below are based on safety factor 4:1.

Maximum lengths values are approximate ones. Most of them have been proven during the manufacturing process.





Collapse pressures are typical values. Some of them have been measured on straight hoses, some at the hose minimum bend radius. The values measured at the minimum bend radius as per ISO 13628-5 are underlined in all tables. A testing programme is in process to test all hoses to ISO 13628-5 requirements.

All values are only valid for hose assemblies, assembled with appropriate Parker fittings acc. to Parker assembly instructions assembled by Parker trained operators.

Hoses with methanol washed Nylon 11 core tube, multiple layers of steel wire and a Nylon outer jacket





Working temperature for these hoses is -40°C to +100°C (-40°F to +212°F)

Chemical resistance of core tube see PFDE-ES28

#									Max length		Collapse pressure (see note)
	size DN	inch mm	inch mm	psi MPa	psi MPa	ft m	lbs/ft kg/m	psi MPa			
2240N-04V91	-04	1/4	0.46	6,250	25,000	11,500	0.11	1,740			
	6	6.5	11.6	43.0	172.5	3,500	0.17	12.0			
2340N-04V91	-04	1/4	0.49	10,000	40,000	11,500	0.15	2,175			
	6	6.4	12.5	69.0	276.0	3,500	0.23	15.0			
2380N-04V91	-04	1/4	0.53	10,000	40,000	10,500	0.18	3,625			
	6	6.4	13.4	69.0	276.0	3,200	0.27	25.0			
2440N-04V91	-04	1/4	0.52	12,500	50,000	10,500	0.21	3,770			
	6	6.4	13.1	87.5	350.0	3,200	0.31	26.0			
2448N-04V91	-04	1/4	0.54	15,000	60,000	9,850	0.25	7,975			
	6	6.3	13.7	103.5	414.0	3,000	0.38	55.0			
2370N-06V91	-06	3/8	0.65	6,250	25,200	8,200	0.22	1,305			
	10	9.7	16.5	43.0	172.5	2,500	0.33	9.0			
2380N-06V91	-06	3/8	0.70	7,500	30,000	8,200	0.30	4,350			
	10	9.8	17.9	51.7	207.0	2,500	0.44	30.0			
2390N-06V91	-06	3/8	0.71	6,450	25,800	10,500	0.28	2,175			
	10	9.8	18.1	44.5	178.0	3,200	0.41	15.0			
2440N-06V91	-06	3/8	0.77	12,500	50,000	10,500	0.50	4,640			
	10	9.8	19.5	87.5	350.0	3,200	0.74	32.0			
2448N-06V91	-06	3/8	0.80	15,000	60,000	9,850	0.58	6,525			
	10	9.7	20.3	103.5	414.0	3,000	0.86	45.0			
2380N-08V91	-08	1/2	0.90	7,500	30,000	9,850	0.46	3,335			
	12	12.9	22.9	51.7	207.0	3,000	0.68	23.0			
2390N-08V91	-08	1/2	0.83	6,000	24,000	11,500	0.39	1,740			
	12	12.9	21.2	41.5	166.0	3,500	0.57	12.0			
2440N-08V91	-08	1/2	0.89	11,745	46,980	9,850	0.64	2,610			
	12	12.7	22.7	81.0	324.0	3,000	0.94	18.0			
2640N-08V91	-08	1/2	0.98	15,000	60,000	9,200	0.95	4,350			
	12	12.8	24.7	103.5	414.0	2,800	1.40	30.0			
2390N-12V91	-12	3/4	1.14	5,000	20,000	10,500	0.61	1,100			
	20	19.4	29.0	34.5	138.0	3,200	0.90	7.5			
2440N-12V91	-12	3/4	1.18	9,135	36,250	6,550	0.99	1,160			
	20	19.6	30.2	63.0	250.0	2,000	1.47	8.0			
2640N-12V91	-12	3/4	1.31	12,500	50,000	5,900	1.45	1,740			
	20	19.8	33.2	87.5	350.0	1,800	2.16	12.0			
2390N-16V91	-16	1	1.38	4,000	16,000	10,500	0.79	500			
	25	25.2	35.0	28.0	112.0	3,200	1.17	3.5			
2440N-16V91	-16	1	1.46	8,120	32,480	6,550	1.28	870			
	25	25.2	37.2	56.0	225.0	2,000	1.90	6.0			
2640N-16V91	-16	1	1.59	10,875	43,500	5,900	1.91	1,160			
	25	26.0	40.2	75.0	300.0	1,800	2.84	8.0			
2380N-20V91	-20	1 1/4	1.73	4,000	16,000	5,900	1.24	1,300			
	32	32.0	44.0	27.5	110.0	1,800	1.83	9.0			

product under development. All values for these hoses are estimated ones.

Large bore hoses with additional TPU outer jacket "ColorGard™"





#									Max length		Collapse pressure
	size DN	inch mm	inch mm	psi MPa	psi MPa	ft m	lbs/ft kg/m	psi MPa			
2440N-16V80	-16	1	1.77	7,500	30,000	6,550	2.03	900			
	25	26.0	45.0	51.7	207.0	2,000	3.00	6.5			
2640N-16V80	-16	1	1.57	15,000*	43,500	5,900	1.96	1,200			
	25	26.0	40.0	103.5*	300.0	1,800	2.90	8.0			
2440N-24V80	-24	1 1/2	2.56	5,000	20,000	4,900	2.84	950			
	40	38.0	65.0	34.5	138.0	1,500	4.20	6.5			
2640N-24V80	-24	1 1/2	2.76	10,000*	33,350	4,900	4.85	950			
	40	38.0	70.0	69.0*	230.0	1,500	7.20	6.5			
2448N-32V80	-32	2	3.15	5,000	20,000	1,970	5.91	710			
	50	50.5	80.0	34.5	138.0	600	8.80	4.9			
2580N-32V80	-32	2	3.31	10,000*	25,000	1,970	6.31	826			
	50	50.5	84.0	69.0*	172.5	600	9.40	5.7			
2640N-48V80	-48	3	5.31	10,000*	33,800	1,970	22.85	900			
	78	76.0	135.0	69.0*	233.0	600	34.00	6.5			





 product under development. All values for these hoses are estimated ones.

* working pressures for these hoses are based on safety factors lower than 4:1.





ChemJec™ hoses with fluoropolymer core tube, multiple layers of steel wire and a Nylon outer jacket.

These hoses have an excellent chemical resistance against most of the aggressive chemicals. Working temperature is -40°C to +100°C (-40°F to +212°F)

#									Max length		Collapse pressure
	size DN	inch mm	inch mm	psi MPa	psi MPa	ft m	lbs/ft kg/m	psi MPa			
2240M-04V30	-04	1/4	0.46	6,250	25,000	11,500	0.11	2,500			
	6	6.4	11.7	43.0	172.5	3,500	0.17	17.0			
2340M-04V30	-04	1/4	0.49	10,000	40,000	11,500	0.16	2,750			
	6	6.4	12.5	69.0	276.0	3,500	0.23	19.0			
2380M-04V30	-04	1/4	0.53	10,000	40,000	10,500	0.18	5,200			
	6	6.4	13.4	69.0	276.0	3,200	0.27	36.0			
2440M-04V30	-04	1/4	0.52	12,500	50,000	10,500	0.21	4,200			
	6	6.4	13.1	87.5	350.0	3,200	0.31	29.0			
2448M-04V30	-04	1/4	0.54	15,000	60,000	8,200	0.26	9,975			
	6	6.4	13.7	103.5	414.0	2,600	0.38	55.0			
2380M-05V30	-05	5/16	0.62	8,700	34,800	6,550	0.23	3,200			
	8	8.2	15.7	60.0	240.0	2,000	0.34	22.0			
2440M-05V30	-05	5/16	0.63	10,000	40,000	6,550	0.33	2,600			
	8	8.2	16.0	69.0	276.0	2,000	0.49	18.0			

#						Max length		Collapse pressure
	size DN	inch mm	inch mm	psi MPa	psi MPa			
2448M-05V30	-05	5/16	0.64	15,000	60,000	8,200	0.35	6,525
	8	8.2	16.3	103.5	414.0	2,500	0.52	45.0
2370M-06V30	-06	3/8	0.64	6,250	25,000	8,200	0.22	2,200
	10	9.9	16.5	43.0	172.5	2,500	0.33	15.0
2448M-06V30	-06	3/8	0.79	15,000	60,000	9,850	0.58	5,650
	10	9.8	20.1	103.5	414.0	3,000	0.86	39.0
2440M-08V30	-08	1/2	0.89	10,000	40,000	9,850	0.63	3,260
	12	12.9	22.7	69.0	276.0	3,000	0.94	22.5
2640M-08V30	-08	1/2	0.97	15,000	60,000	9,200	0.58	4,400
	12	12.7	24.7	103.5	414.0	2,800	0.86	30.0
2390M-12V30	-12	3/4	1.14	5,000	20,000	10,500	0.61	1,090
	20	19.8	29.0	34.5	138.0	3,200	0.90	7.5
2440M-12V30	-12	3/4	1.19	9,135	36,250	6,550	0.99	1,600
	20	19.8	30.2	63.0	250.0	2,000	1.46	11.0

Large bore hoses with additional TPU outer jacket "ColorGard™"

#						Max length		Collapse pressure
	size DN	inch mm	inch mm	psi MPa	psi MPa			
2640M-16V80	-16	1	1.57	10,000*	33,350	6,550	1.96	900
	25	26.0	40.0	69.0*	230.0	2,000	2.90	6.5
2640M-24V80	-24	1 1/2	2.76	10,000*	33,350	4,900	4.85	1200
	40	38.0	70.0	69.0*	230.0	1,500	7.20	8.0
2448M-32V80	-32	2	3.15	5,000	20,000	1,970	5.91	650
	50	50.5	80.5	34.5	138.0	600	8.80	4.5
2580M-32V80	-32	2	3.31	10,000*	25,000	1,970	6.31	940
	50	50.5	84.5	69.0*	172.5	600	9.40	6.5

 product under development. All values for these hoses are estimated ones.





* working pressures for these hoses are based on safety factors lower than 4:1.

PFDE-ES29

SeaWolf® high collapse resistance aramid reinforced hoses with nylon core tube and TPU outer jacket.

Working temperature for these hoses is -40°C to +60°C (-40°F to +140°F)





Chemical resistance of core tube see PFDE-ES28

#						Max length		Collapse pressure
	size DN	inch mm	inch mm	psi MPa	psi MPa		ft m	
57CRN-08V02	-08	1/2	1.18	5,000	20,000	656	0.63	4,350
	12	12.7	30.0	34.5	138.0	200	0.94	30.0
57CRN-16V02	-16	1	2.00	5,000	20,000	656	1.45	3,000
	25	25.4	50.8	34.5	138.0	200	2.17	20.0

Hoses with methanol washed Nylon 11 core tube, multiple aramide yarn braids and a TPU outer jacket

Working temperature for these hoses is -40°C to +55°C (-40°F to +130°F)

Chemical resistance of core tube see PFDE-ES28

#						Max length		Collapse pressure
	size DN	inch mm	inch mm	psi MPa	psi MPa		ft m	
2022N-04V91-5K	-04	1/4	0.50	5,000	20,000	6,550	0.08	2,900
	6	6.4	12.7	34.5	138.0	2,000	0.12	20.0
2022N-04V91-10K	-04	1/4	0.54	10,000	40,000	8,200	0.09	800
	6	6.4	13.8	69.0	276.0	2,500	0.14	5.5
2022N-06V91-5K	-06	3/8	0.63	5,000	20,000	6,550	0.10	200
	10	9.7	16.1	34.5	138.0	2,000	0.15	1.4
2022N-06V91-10K	-06	3/8	0.70	10,000	40,000	6,550	0.10	<145
	10	9.8	17.9	69.0	276.0	2,000	0.15	<1.0
2022N-08V91-5K	-08	1/2	0.90	5,000	20,000	6,550	0.10	<145
	12	12.9	22.9	34.5	138.0	2,000	0.15	<1.0
2022N-08V91-10K	-08	1/2	0.91	10,000	40,000	6,550	0.23	<145
	12	12.9	23.1	69.0	276.0	2,000	0.34	<1.0

Parker engineering manual

recommended practices for handling, maintenance and inspection of long length Parker polyflex offshore hoses and hose assemblies

Parker Publication No. PFDE-ES28
Revised: Oct 2006

1 SCOPE

This engineering standard provides recommended practices for handling, maintenance and inspection of Parker Polyflex multispiral wire reinforced hoses and hose assemblies.

These hoses are being increasingly used subsea for applications such as annulus service lines, hot line and light well intervention in lengths of up to 3,000 m.

Deployed as single line hoses or used in bundles, the hoses are available in sizes range from 3/16" to 2" inside diameter. The hoses may be further protected by an additional sheath or incorporate a dual colour, extra thick ColorGard™ sheath.

Hose can be self supporting, clamped, or supported by a guide wire.

It is essential that the customer details the actual operating conditions of the hose to enable Parker to recommend the best hose construction for the application.

SAE J1273 is an excellent document providing general guidelines for selection, routing, fabrication, installation, replacement, maintenance, and storage of hose and hose assemblies for fluid power systems. SAE J1273, and Parkers experience in supplying products to the offshore industry provide the basis for the recommendations included in this engineering standard.

2 HOSE FEATURES

Parker Polyflex multispiral wire reinforced hoses are suitable for use in the offshore environment. They are tough, offer excellent chemical, external collapse, ozone and microbiological resistance. In extreme conditions, additional protection can be added

by specifying the ColorGard™ extra thick sheath safety feature or an additional protective oversheath.

3 STORAGE

Hoses and hose assemblies should be stored, wherever possible, protected from the elements in a stress free condition either straight, in a coil, or on a drum. The inside diameter of the coil or drum should not be less than two times the minimum bend radius. The fittings should be capped to prevent ingress of dirt or other contamination and any exposed threads protected from damage.

Storage of hoses and hose assemblies should take into account potential exposure to corrosive liquids, rodents, insects and high temperatures.

4 HANDLING

Only trained personnel should handle and connect hose assemblies.

Incorrect handling will seriously reduce the lifetime of the hose and could cause dramatic failure. The use of wire rope or chains directly against the outer cover should be avoided, and the routing of the assembly should ensure the hose is never bent below its minimum bend radius. Special attention should be paid to the area at the back of the fitting.

When reeling long length hose onto a drum it is essential to minimise the tension on the hose. Proof testing of a "stretched" hose while on the drum can cause premature failure of the hose or damage to the drum.

When operating from a winch it is recommended that the hose is pressurised during the deployment and retrieving operation.

This significantly reduces the potential for deforming the hose during storage and is very important if it is planned to proof test the hose while on winch. Pressures up to 20 MPa had been found satisfactory but this depends on the hose and local safety regulations. Pressures should not exceed the working pressure of the hose assembly.

When re-spooling, the pay-off and take-up drums should be inline and a minimum of 10m apart (see Fig.1). The hose should be spooled from the top of the pay-off drum onto the top of the take-up drum. This follows the natural set in the hose and minimises the possibility of inducing twist into the hose.

When re-spooling a new hose that has a polyurethane cover, it is recommended to lubricate the hose cover with soapy water or other suitable lubricant so the hose will traverse more easily and position itself correctly onto the take-up drum/winch.

Fig.1 Hose re-spooling

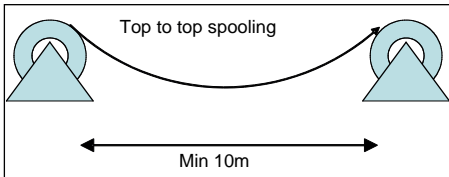

5 POSSIBLE CAUSES OF PREMATURE FAILURE, AND SUGGESTED PREVENTATIVE MEASURES

5.1 Bending the hose below the minimum bend radius

This is most likely to occur if the end fitting is not supported during lifting, a support sling wrongly positioned, or the hose being pulled round a tight corner.

Bend restrictors and containment grips are useful accessories that help to reduce this type of handling problem.

5.2 Damage of the hose cover

If the hose cover is damaged to the extent that the reinforcing wires are exposed, corrosion of the wires will occur causing a progressive reduction in burst pressure, and ultimately failure.

If used subsea, the damaged cover will allow water to ingress into the carcass of the hose and cause the core tube to collapse.

The ColorGard™ extra thick, dual colour cover option minimises the risk of exposing the reinforcing wires. If the outer cover is being abraded, the subsequent exposure of the red inner cover gives a visual early warning that a hose needs repairing or replacing.

5.3 Kinked, crushed, twisted or flattened hose

Any major distortion of the hose will also affect the function and alignment of the reinforcing wires. This will reduce the burst pressure and the external collapse pressure and could result in a sudden catastrophic failure of the hose.

5.4 Chemical attack or ageing of the core tube

The use of chemicals at differing concentrations and/or temperatures can have a major effect on the life of a hose and may cause dramatic hose failure.

5.5 Damage or corrosion of the end fitting

Incorrect handling or insufficient flushing after use could result in damage or corrosion of the end fitting. This will make connection difficult, probably cause leakage, and could result in sudden failure of the connection.

5.6 Excessively high flow rates

Depending on the abrasive properties of the fluid, high flow rates can result in erosion in the bore of the end fitting. Due to the resilience of the core tube material it is normally the fitting which gives the first indication of erosion, but the core tube could be damaged as well.

6 INSPECTION AND MAINTENANCE

- 6.1 A complete visual inspection of the hose assembly should be made prior to the start of any operation. Any of the following conditions shall require immediate removal of the hose assembly from service.

- Damage to the outer cover which exposes the reinforcing wires.
- Kinked, crushed, flattened or twisted hose.
- Blistered, soft, degraded, or loose outer cover.
- Cracked, damaged, or badly corroded fittings.

If in doubt, a damaged hose assembly should be returned to the original supplier for inspection.

- 6.2 After completion of each job both inside and outside hose surfaces should be flushed with sufficient clean water to ensure that all chemicals or residues are fully removed from the hose assembly.
- 6.3 It is recommended that hose assemblies be returned to the original supplier at least once a year for inspection. The supplier will issue a report detailing the condition of the assembly, and recommend recertification, repair, or replacement.

National laws or conditions may require a different testing frequency.

Chemical resistance for Nylon 11

Nylon 11 is the most common core tube material used for Parker Polyflex oil & gas hoses. Please refer to the hose data sheet.

Ratings code

- * - Swelling
- A - Good
- B - Limited
- X - Unsatisfactory

Chemical	Concentration	20°C (68°F)	40°C (104°F)	60°C (140°F)
Acetaldehyde		A	B	X
Acetic Acid	5%	A	A	A
Acetic Acid	10%	A	A	B
Acetic Acid	50%	B		
Acetic Anhydride		B	X	X
Acetone	Pure	A	A	A
Acetylene		A	A	A
Aluminium Sulfate	Sat Sol.	A	A	A
Ammonia	Liquid or Gas	A	A	A
Ammonium Chloride		A	A	A
Ammonium Hydroxide	Concentrated	A	A	A
Ammonium Nitrate		A	A	A
Ammonium Sulfate	Saturated Solution	A	A	B
Amyl Acetate		A	A	A
Aniline		B*	X	X
Barium Chloride	Saturated Solution	A	A	A
Benzaldehyde		A	B	X
Benzene		A	A*	B
Bezyl Alcohol		B	X	X
Butane		A	A	A
Butyl Alcohol		A*	B	X
Calcium Arsenate		A	A	A
Calcium Chloride	Saturated Solution	A	A	A
Calcium Nitrate		A		

Technical Info

Chemical	Concentration	20°C (68°F)	40°C (104°F)	60°C (140°F)
Camphor		A		
Carbon Disulfide		A*	B*	X
Carbon Tetrachloride		B	X	
Cement Slurries		A	A	A
Chloroform		B	X	X
Citric Acid	Saturated Solution	A	A	B
Copper Sulfate		A	A	A
Cyclohexane		A	A	B
Cyclohexanol		A	B	X
Cyclohexanone		A	B	X
Diammonium Phosphate		A	A	B
Dichloroethylene		B	X	
Diesel		A	A	
Diethanolamine	20%	A	A*	A*
Diethyl Ether		A		
Dioctylphosphate		A	A	A
Dioctylphthalate		A	A	A
Ethanol	Pure	A*	B	X
Ethyl Acetate		A	A	A
Ethylene Glycol		A*	A*	B
Ethylene Oxide		A	A	B
Fatty Acid Esters		A	A	A
Formaldehyde	Technical	A	B	X
Formic Acid	9%	A	B	X
Furfuryl Alcohol		A	A*	B
Gas (Coal)		A	A	
Gasoline (High Octane)		A	A	A*
Glucose		A	A	A
Glycerine	Pure	A	A	B
Glycol		A	A	B
Heptane		A	A	A*
Hydrogen		A	A	A
Hydrogen Peroxide	20%	A	B	
Hydrochloric Acid	10%	A	A	X
Hydrochloric Acid	20%	A	X	X
Hydrofluoric Acid	3%	A	B	X

Chemical resistance for Nylon 11

Chemical	Concentration	20°C (68°F)	40°C (104°F)	60°C (140°F)
Isocyanates		B		
Isopropyl Alcohol		A		
Kerosene		A	A	A*
Lactic Acid		A	A	A
Magnesium Chloride	50%	A	A	A
Mercury		A	A	A
Methane		A	A	A
Methanol	Pure	A	B	B*
Methyl-Cellosolve		A	A	A
Methyl Acetate		A	A	A
Methyl Bromide		A	X	
Methyl Chloride		A	B	
Methyl Sulfate		A	A	B
Methyl Ethyl Ketone		A	A	B
Methyl Isobutyl Ketone		B	X	X
Monochlorobenzene		A	A	A*
Naphta		A	A	A
Naphtalene		A	A	A
Oil Crude		A	A	A
Oils Refined		A	A	A
Oleic Acid		A	A	A
Oxalic Acid		A	A	B
Perchloroethylene		B	X	
Phosphoric Acid	40%	A	B	X
Picric Acid		B	X	X
Potassium Carbonate		A	A	B
Potassium Chloride		A	A	B
Potassium Hydroxide	50%	A	B	X
Potassium Nitrate		A*	B*	X
Potassium Sulfate		A	A	A
Propane		A	A	A
Pydraul F9		A	A	A
Pyridine	Pure	B	X	X
Sodium Carbonate	Saturated Solution	A	A	B
Sodium Chloride	Saturated Solution	A	A	A
Sodium Hydroxide	50%	A	B	X

Technical Info

Chemical	Concentration	20°C (68°F)	40°C (104°F)	60°C (140°F)
Sodium Hypochlorite	Concentrated	B	X	X
Sodium Hypochlorite	Dilute Commercial Grade	A	B	X
Sodium Sulfide		A	B	B
Stearin		A	A	A
Stearic Acid		A	A	A
Styrene Monomer		A	A*	
Sulfic Anhydride		B	X	X
Tartaric Acid		A	A	A
Tetraethyl Lead		A		
Tetrahydrofurane		A	A	B
Toluene		A	A*	B
Trichloroethane		B	X	
Trichloroethylene		B	X	
Tricresyl Phosphate		A	A	A
Tributyl Phosphate		A	A	A
Trisodium Phosphate		A	A	A
Triphenyl Phosphate		A	A	B
Turpentine		A	A	A*
Urea		A	A	B
Uric Acid		A	A	A
Vinegar		A	A	A
Water		A	A	A
Water Sea		A	A	A
Water Soda		A	A	A
Xylene		A	A*	B
Zinc Chloride		A	A	B

General chemical resistance table

Ratings code

- G – Good to excellent. Little or no swelling, tensile or surface changes. Preferred choice.
- L – Marginal or conditional. Noticeable effects but not necessarily indicating lack of serviceability. Further testing suggested for specific application. Very long-term effects such as stiffening or potential for crazing should be evaluated.
- P – Poor or unsatisfactory. Not recommended without extensive and realistic testing.
- – Indicates that this was not tested.

Materials code for hose core tubes

- N** Polyamide
- M** Coextruded tube with Fluoropolymer inner liner

Materials code for hose cover

- N** Polyamide

Notes on the chemical resistance table

- (1) The fluid resistance tables are simplified rating tabulations based on immersion tests at 24° C. Higher temperatures tend to reduce ratings. Since final selection depends on pressure, fluid and ambient temperature and other factors not known to Parker Hannifin, no performance guarantee is expressed or implied. The indications do not imply any compliance with standards and regulations and do not refer to possible changes of colour, taste or smell. For food and drinking water specially approved materials have to be used. For fluids not listed or for advice on particular applications, please consult Parker Hannifin GmbH, **polyflex**[™] Division in Hüttenfeld, Germany.
- (2) Hose applications for these fluids must take into account legal and insurance regulations. The chemical resistance indicated does not express or imply approval by certain institutions.
- (3) Satisfactory at some concentrations and temperatures, unsatisfactory at others.
- (4) For gas applications, the cover should be pin-pricked and the pressure must not be released quickly. Special safety guard accessories are to be used to prevent damage or personal injury in the event of failure.
- (5) Chemical resistance does not imply low permeation rates. Please consult Parker Hannifin for a recommendation for your specific requirements.
- (6) The indication of chemical resistance does not imply any special food compatibility; it refers only to the chemical resistance of the material.
- (7) Chemical resistance does not imply acceptability for use in airless paintspray applications. These applications require a special, electrically conductive hose.

Not all remarks may apply to Oil&Gas products

Chemical	N	M
Acetic Acid	L	G
Acetone	G	G
Acetylene	--	--
Air (4)	G	G
Ammonium Chloride	P	G
Ammonium Hydroxyde	G	G
Anhydrous Ammonia	P	G
Aniline	P	G
Aqueous Ammonia	G	G
Aromatic Hydrocarbons	G	G
Asphalt	G	G
Benzene	G	G
Butane (2) (4)	G	G
Calcium Chloride	--	G
Carbon Dioxide (4)	G	G
Carbon Monoxide (4)	--	G
Carbon Tetrachloride	G	G
Chlorinated Hydrocarbon Base Fluids	G	G
Chlorinated Petroleum Oil	G	G
Chlorinated Solvents	--	G
Chlorine, Gaseous, Dry	P	G
Chloroform	L	G
Chromic Acid	--	G
Citric Acid Solutions	G	G
Crude Petroleum Oil	G	G
Cyclohexan (2)	G	G
Diesel Fuel (2)	G	G
Diester Oils	G	G
Diethylamine	--	G
Ethanol (6)	G	G
Ethers	G	G
Ethyl Acetate	G	G
Ethylene Glycol	G	G
Ethylene Oxide	G	G
Fatty Acids	G	G
Formaldehyde	L	G
Formic Acid J	P	G
Fuel Oil (2)	G	G

General chemical resistance table

Chemical	N	M
Gas (Oil) (2)	G	G
Gasoline	G	G
Glycerine	G	G
Glycols (to 57 °C / 135 °F)	G	G
Grease (petroleum base)	G	G
Hexane (2)	G	G
Hydraulic Fluid (petroleum base)	G	G
Hydraulic Fluid phosphate ester base)	G	G
Hydraulic Fluid water base)	G	G
Hydraulic oil (petroleum base)	G	G
Hydrochloric Acid	L	G
Hydrofluoric Acid	P	G
Hydrolube (hydraulic fluid/water glycol base)	G	G
IRUS 902 (hydraulic fluid/water-oil emulsion)	G	G
Isooctane (2)	G	G
Kerosene (2)	G	G
Ketones	G	G
Lime (calcium oxide)	G	G
Lindol (hydraulic fluid/phosphate esters)	G	G
LP-Gas	--	G
Lubricating Oils (diester base)	G	G
Lubricating Oils (petroleum base)	G	G
Methane	--	G
Methanol	G	G
Methyl Ethyl Ketone (MEK)	G	G
Methyl Ethyl Ketone Peroxide (MEKP)	L	--
Methyl Isobutyl Ketone (MIBK)	G	G
Methylene Chloride	L	G
Mineral Oil	G	G
Mineral Spirits	--	--
Motor Oils	G	G
Naphta	G	G
Natural Gas (4)	--	G
Nitric Acid	P	G
Nitrobenzene	G	G
Nitrogen, Gaseous (4) (5)	G	G
Nitrous Oxide	L	G
Oil (SAE)	G	G

Technical Info

Chemical	N	M
Oxygen, Gaseous (4) (5) (6)	G	G
Ozone	P	G
Pentane (2)	G	G
Perchloric Acid	P	L
Petroleum Ether	--	G
Petroleum Oils	G	G
Phenols	P	G
Phosphate Esters (above 57 °C / 135 °F)	G	G
Phosphate Esters (to 57 °C / 135 °F)	G	G
Propane (4) (5)	--	G
Propylen Glycol	--	G
Salt Water	--	G
Silicone Greases	G	G
Silicone Oils	G	G
Sodium Borate	G	G
Sodium Carbonate	--	G
Sodium Chloride Solutions	G	G
Sodium Hydroxide, 50%	P	G
Sodium Hypochlorite	P	G
Steam	P	G
Straight Synthetic Oils (phosphate esters)	G	G
Sulphur Dioxide	L	G
Sulphur Hexafluoride Gas (4) (5)	G	G
Sulphuric Acid	P	G
Toluol, Toluene	G	G
Trichlorethylene	L	G
Ucon (hydraulic fluid/water glycol base)	G	G
Water (above 60 °C / 140 °F) (6)	G	G
Water (to 60 °C / 140 °F) (6)	G	G
Water Glycols (above 60 °C / 140 °F)	L	G
Water Glycols (to 60 °C)	G	G
Water in oil Emulsions (above 60 °C / 140 °F)	L	G
Water in oil Emulsions (to 60 °C / 140 °F)	G	G
Xylene	G	G
Zinc Chloride	G	G

Pressure drop tables for different hose sizes

Remarks

Figures shown in the table are for 1 m of hose without fittings.
 Figures derived from calculation. not from testing.
 The recommended max fluid velocity is 7.6 m/s. Hoses have been used at higher fluid velocities. However this may result in cavitation. These flow figures are marked with a grey background.
 Fluid: water
 Dyn. viscosity: 1002 mPa s
 Kin. viscosity: 1002 cSt
 Temperature: 20 °C

Flowrates 5 up to 80 l/min. sizes 5 mm (-03) up to 13 mm (-08)

Flowrate		Pressure drop in bar/m				
[l/min]	Gal (US)/min	nominal IDs				
		5 mm -03	6 mm -04	8 mm -05	10 mm -06	13 mm -08
5	1.3	0.40	0.54	0.13	0.05	0.02
10	2.6	1.44	1.96	0.48	0.16	0.07
15	4.0		4.35	1.07	0.36	0.15
20	5.3			1.80	0.61	0.25
25	6.6			2.70	0.91	0.38
30	7.9				1.27	0.52
35	9.2				1.69	0.69
40	10.6					0.90
45	11.9					1.12
50	13.2					1.35
60	15.9					1.91
70	18.5					
80	21.1					

Maximum flowrates for sizes 5 mm (-03) up to 13 mm (-08)

Maximum fluid horizontal velocity is 7.6 m/s (laminar flow)	Max. volumetric flowrate				
	nominal IDs				
	5 mm -03	6 mm -04	8 mm -05	10 mm -06	13 mm -08
Radius r in mm	2.50	3.00	4.00	5.00	6.50
Area in mm ²	19.63	28.27	50.27	78.54	132.73
Max. flowrate m ³ /min	0.01	0.01	0.02	0.04	0.06
Max. flowrate Gallons/min	2.36	3.40	6.05	9.46	15.98
Max. flowrate Liter/min	8.95	12.89	22.91	35.80	60.50
Max. flowrate bbl/min	0.06	0.08	0.14	0.23	0.38

Hydraulic chart sizes 5 mm (-03) up to 13 mm (-08)

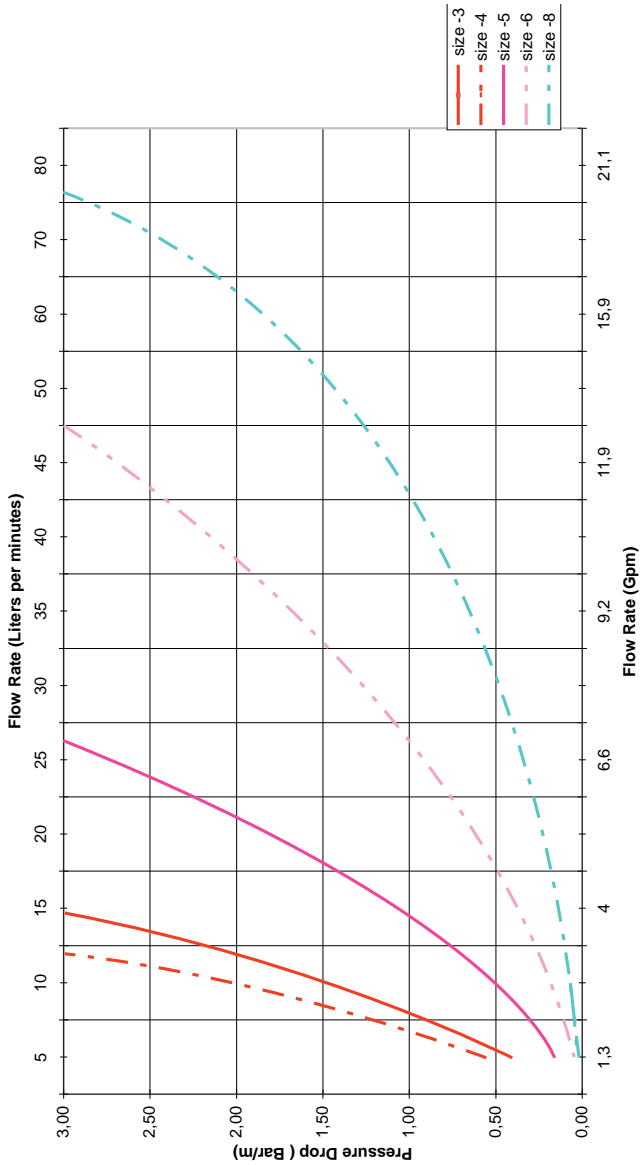

Flowrates 50 up to 4500 l/min. sizes 20 mm (-12) up to 76 mm (-48)

Flowrate			Pressure drop in bar/m					
l/min	US Gal/min	Oilfield BBL/min	nominal IDs					
			20 mm -12	25 mm -16	32 mm -20	38 mm -24	50 mm -32	76 mm -48
50	13	0,31	0,01	0,01	0,00	0,00	0,00	0,00
100	26	0,62	0,16	0,04	0,01	0,01	0,00	0,00
150	40	0,95	0,36	0,09	0,03	0,01	0,00	0,00
200	53	1,26	0,61	0,15	0,05	0,02	0,01	0,00
250	66	1,57	0,91	0,22	0,07	0,03	0,01	0,00
300	79	1,88	1,27	0,31	0,10	0,04	0,01	0,00
400	106	2,52		0,54	0,17	0,07	0,02	0,00
500	132	3,14		0,81	0,26	0,11	0,03	0,00
700	185	4,41			0,49	0,21	0,05	0,01
1000	264	6,29			0,94	0,40	0,10	0,01
1500	396	9,43				0,86	0,21	0,03
2000	528	12,57					0,36	0,05
3000	793	18,88						0,11
3500	925	22,02						0,14
4000	1057	25,17						0,18
4500	1189	28,30						0,22

Maximum flowrates for sizes 20 mm (-12) up to 76 mm (-48)

Maximum fluid horizontal velocity is 15 m/s (laminar flow)	Max. volumetric flowrate					
	nominal IDs					
	20 mm -12	25 mm -16	32 mm -20	38 mm -24	50 mm -32	76 mm -48
Radius r in mm	10.0	12.5	16.0	19.0	25.0	38.0
Area in mm ²	314.2	490.9	804.2	1134.1	1963.5	4536.5
Max. flowrate m ³ /min	0,3	0,4	0,7	1,0	1,8	4,1
Max. flowrate Gallons/min	74,7	116,6	191,1	269,5	466,6	1078,0
Max. flowrate Liter/min	282,6	441,6	723,5	1020,2	1766,3	4080,7
Max. flowrate bbl/min	1,8	2,8	4,6	6,4	11,1	25,7

J

Technical information
Pressure drop tables

Hydraulic chart sizes 20 mm (-12) up to 76 mm (-48)

The chart displays the relationship between pressure drop and flow rate for six different hose sizes. The x-axis represents Pressure Drop in Bar/m, ranging from 0.00 to 1.00. The left y-axis represents Flow Rate in Liters per minutes (L/min), ranging from 50 to 4500. The right y-axis represents Flow Rate in Gallons per minute (Gpm), with major ticks at 13, 40, 66, 106, 185, 396, 793, and 1057. The legend identifies the curves for sizes 12, 16, 20, 24, 32, and 48.

Pressure Drop (Bar/m)	Size 12 (L/min)	Size 16 (L/min)	Size 20 (L/min)	Size 24 (L/min)	Size 32 (L/min)	Size 48 (L/min)
0.00	50	50	50	50	50	50
0.10	60	80	120	180	250	350
0.20	70	100	150	220	300	400
0.30	80	120	200	280	380	500
0.40	90	140	250	350	450	600
0.50	100	160	300	400	500	700
0.60	110	180	350	450	550	800
0.70	120	200	400	500	600	900
0.80	130	220	450	550	650	1000
0.90	140	240	500	600	700	1100
1.00	150	260	550	650	750	1200

J-21

Catalogue 4465

Technical Info

Recommended tightening procedures

Connection	Thread sizes	Tightening torque	
		ft•lb	N•m
High Pressure			
1/4"	9/16" - 18UNF	25	34
3/8"	3/4" - 16UNF	50	69
9/16"	1-1/8" - 12UNF	75	103
Medium Pressure			
1/4"	7/16" - 20UNF	20	28
3/8"	9/16" - 18UNF	30	41
9/16"	13/16" - 16UNF	85	117
3/4"	3/4" NPSM	90	124
1"	1-3/8" - 12UNF	125	173
Type "M" Swivel			
A9	9/16" - 18UNF	25-30	34-41
A12	3/4" - 16UNF	40-50	55-69
A14	7/8" - 14UNF	50-60	69-83
A16	1" - 12UNF	75-85	103-117
A21	1-5/16" - 12UNF	100-120	138-166

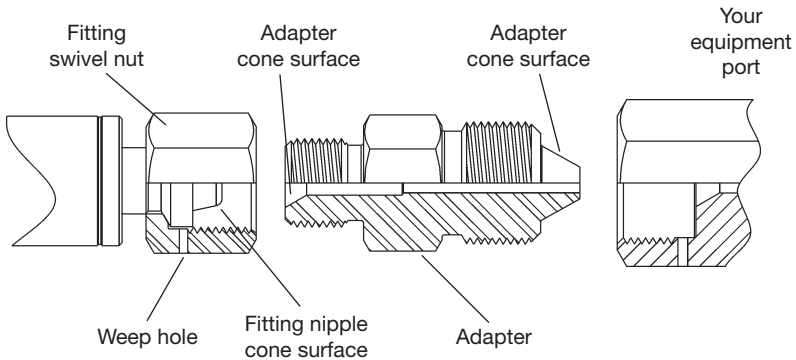

Leakage at swivel nut-to-adapter Joint

(Seen by leak at weep hole in swivel nut)

1. Reduce system pressure to zero
2. Unscrew swivel nut and check cone surfaces of adapter and hose insert.
3. If hose insert is damaged, return hose to **polyflex** for repair and retest.
4. If cone surfaces look good after cleaning, re-tighten swivel nut. Do not exceed 150% of recommended torque.

Leakage at type "M" adapter-to-port

(Seen by leak at weep hole in pressure port, or leak at threads for NPT adapters.)

1. Reduce system pressure to zero.
2. Slacken hose swivel nut.
3. Tighten adaptor into port.
4. Re-tighten swivel nut.

Never use the swivel nut to tighten the adapter into the port.

Test equipment for qualification testing and production control

Preliminary note

Before our hoses and fittings enter the market, they are subjected to a rigorous test program. With the specialised test equipment we test our hoses and fittings according to recognized international standards.

Below you find a short overview of our test equipment. We also offer a testing service. All testing can be witnessed by an authority of your choice.

All test equipment is calibrated by accredited companies.

1. Static pressure test rigs and climate chamber

Parker Polyflex is able to conduct all kinds of static pressure tests.

Type of test: leakage, burst, proof pressure, change in length, volumetric expansion

Maximum test pressure: 1,000 MPa (145,000 psi). For volumetric expansion: 400 MPa (58,000 psi).

Test medium: water or glycol.

Applicable standards: ISO 13628-5, ISO 1402, SAE J343

The fully computerized system allows free adjustment of pressurize rate and full documentation.

With another test rig static pressure testing including pressure decay tests on finished hose lengths including large bore hoses, umbilicals, and/or very long lengths can be done. Pressure graphs can be supplied on request.

More static pressure test rigs are installed in the production area. They are used for final pressure testing of ultra high pressure hose assemblies.

The climate chamber can be programmed for cyclic testing at temperatures between -70 °C and +170 °C.



2. Impulse test rigs

An impulse test is considered to be the most demanding test, which gives the best indication of the quality of the hose assembly. Parker Polyflex is equipped with the most advanced impulse test rigs, which are used for hose and fitting qualification and periodical quality control testing. With the unique impulse test rig, Parker Polyflex is the only company worldwide, which is able to conduct impulse testing fully complying with ISO 13628-5, EN 1829-2 and ISO 6803 (square pressure curve) at pressures up to 500 MPa (72,500 psi).

Maximum test pressure: 500 MPa (72,500 psi)

Maximum medium temperature: 140°C

Test medium: mineral oil

Applicable standards: ISO 13628-5, EN 1829-2, ISO 6803, SAE J343

Pressure curve: free adjustable to meet national or international standards or specific customer requirements.



3. Collapse pressure test rig

This rig allows testing at external pressures up to 60 MPa (87,000 psi). The dimensions of the pressure chamber and a special arrangement of the hose allows testing of up to 4" hoses. The testing can be conducted at elevated temperatures up to 93 °C. Test medium is water.



Parker safety guide

for selecting and using hose, tubing, fittings, and related accessories

Parker Publication No. 4400-B.1
Revised: May 2002

WARNING: Failure or improper selection or improper use of hose, tubing, fittings, assemblies or related accessories ("Products") can cause death, personal injury and property damage. Possible consequences of failure or improper selection or improper use of these Products include but are not limited to:

- Fittings thrown off at high speed.
- High velocity fluid discharge.
- Explosion or burning of the conveyed fluid.
- Electrocutation from high voltage electric power lines.
- Contact with suddenly moving or falling objects that are controlled by the conveyed fluid.
- Injections by high-pressure fluid discharge.
- Dangerously whipping Hose.
- Contact with conveyed fluids that may be hot, cold, toxic or otherwise injurious.
- Sparking or explosion caused by static electricity buildup or other sources of electricity.
- Sparking or explosion while spraying paint or flammable liquids.
- Injuries resulting from inhalation, ingestion or exposure to fluids.

Before selecting or using any of these Products, it is important that you read and follow the instructions below. Only Hose from Parker's Stratoflex Products Division is approved for in flight aerospace applications, and no other Hose can be used for such in flight applications.

1.0 GENERAL INSTRUCTIONS

- 1.1 Scope: This safety guide provides instructions for selecting and using (including assembling, installing, and maintaining) these Products. For convenience, all rubber and/or thermoplastic products commonly called "hose" or "tubing" are called "Hose" in this safety guide. All assemblies made with Hose are called "Hose Assemblies". All products commonly called "fittings" or "couplings" are called "Fittings". All related accessories (including crimping and swaging machines and tooling) are called "Related Accessories". This safety guide is a supplement to and is to be used with, the specific Parker publications for the specific Hose, Fittings and Related Accessories that are being considered for use.
- 1.2 Fail-Safe: Hose, and Hose Assemblies and Fittings can and do fail without warning for many reasons. Design all systems and equipment in a fail-safe mode, so that failure of the Hose or Hose Assembly or Fitting will not endanger persons or property.
- 1.3 Distribution: Provide a copy of this safety guide to each person that is responsible for selecting or using Hose and Fitting products. Do not select or use Parker Hose or Fittings without thoroughly reading and understanding this safety guide as well as the specific Parker publications for the products considered or selected.
- 1.4 User Responsibility: Due to the wide variety of operating conditions and applications for Hose and Fittings, Parker and its distributors do not represent or warrant that any particular Hose or Fitting is suitable for any specific end use system. This safety guide does not analyze all technical parameters that must be considered in selecting a product. The user, through its own analysis and testing, is solely responsible for:
- Making the final selection of the Hose and Fitting.
 - Assuring that the user's requirements are met and that the application presents no health or safety hazards.
 - Providing all appropriate health and safety warnings on the equipment on which the Hose and Fittings are used.
 - Assuring compliance with all applicable government and industry standards.

1.5 Additional Questions: Call the appropriate Parker technical service department if you have any questions or require any additional information. See the Parker publication for the product being considered or used, or call 1-800-CPARKER, or go to www.parker.com, for telephone numbers of the appropriate technical service department.

2.0 HOSE AND FITTING SELECTION INSTRUCTIONS

2.1 Electrical Conductivity: Certain applications require that the Hose be nonconductive to prevent electrical current flow. Other applications require the Hose and the Fitting and the Hose/Fitting interface to be sufficiently conductive to drain off static electricity. Extreme care must be exercised when selecting Hose and Fittings for these or any other applications in which electrical conductivity or nonconductivity is a factor.

The electrical conductivity or nonconductivity of Hose and Fittings is dependent upon many factors and may be susceptible to change. These factors include but are not limited to the various materials used to make the Hose and the Fittings, Fitting finish (some Fitting finishes are electrically conductive while others are nonconductive), manufacturing methods (including moisture control), how the Fittings contact the Hose, age and amount of deterioration or damage or other changes, moisture content of the Hose at any particular time, and other factors.

The following are considerations for electrically nonconductive and conductive Hose. For other applications consult the individual catalog pages and the appropriate industry or regulatory standards for proper selection.

2.1.1 Electrically Nonconductive Hose: Certain applications require that the Hose be nonconductive to prevent electrical current flow or to maintain electrical isolation. For these applications that require Hose to be electrically nonconductive, including but not limited to applications near high voltage electric lines, only special nonconductive Hose can be used. The manufacturer of the equipment in which the nonconductive Hose is to be used must be consulted to be

certain that the Hose and Fittings that are selected are proper for the application. Do not use any Parker Hose or Fitting for any such application requiring nonconductive Hose, including but not limited to applications near high voltage electric lines, unless (i) the application is expressly approved in the Parker technical publication for the product, (ii) the Hose is marked “nonconductive”, and (iii) the manufacturer of the equipment on which the Hose is to be used specifically approves the particular Parker Hose and Fitting for such use.

2.1.2 Electrically Conductive Hose: Parker manufactures special Hose for certain applications that require electrically conductive Hose. Parker manufactures special Hose for conveying paint in airless paint spraying applications. This Hose is labeled “Electrically Conductive Airless Paint Spray Hose” on its layline and packaging. This Hose must be properly connected to the appropriate Parker Fittings and properly grounded in order to dissipate dangerous static charge buildup, which occurs in all airless paint spraying applications. Do not use any other Hose for airless paint spraying, even if electrically conductive. Use of any other Hose or failure to properly connect the Hose can cause a fire or an explosion resulting in death, personal injury, and property damage. Parker manufactures a special Hose for certain compressed natural gas (“CNG”) applications where static electricity buildup may occur. Parker CNG Hose assemblies comply with AGA Requirements 1-93, “Hoses for Natural Gas Vehicles and Fuel Dispensers”. This Hose is labeled “Electrically Conductive for CNG Use” on its layline and packaging. This Hose must be properly connected to the appropriate Parker Fittings and properly grounded in order to dissipate dangerous static charge buildup, which occurs in, for example, high velocity CNG dispensing or transfer. Do not use any other Hose for CNG applications where static charge buildup may occur, even if electrically conductive. Use of other Hoses in CNG applications or failure to properly connect or ground this Hose can cause a fire or an explosion resulting in death, personal injury, and property damage. Care must also be taken to protect

- against CNG permeation through the Hose wall. See section 2.6, Permeation, for more information. Parker CNG Hose is intended for dispenser and vehicle use at a maximum temperature of 180°F. Parker CNG Hose should not be used in confined spaces or unventilated areas or areas exceeding 180°F. Final assemblies must be tested for leaks. CNG Hose Assemblies should be tested on a monthly basis for conductivity per AGA 1-93.
- Parker manufactures special Hose for aerospace in-flight applications. Aerospace in-flight applications employing Hose to transmit fuel, lubricating fluids and hydraulic fluids require a special Hose with a conductive inner tube. This Hose for in-flight applications is available only from Parker's Stratoflex Products Division. Do not use any other Parker Hose for in-flight applications, even if electrically conductive. Use of other Hoses for in-flight applications or failure to properly connect or ground this Hose can cause a fire or an explosion resulting in death, personal injury, and property damage. These Hose assemblies for in-flight applications must meet all applicable aerospace industry, aircraft engine, and aircraft requirements.
- 2.2 Pressure: Hose selection must be made so that the published maximum recommended working pressure of the Hose is equal to or greater than the maximum system pressure. Surge pressures or peak transient pressures in the system must be below the published maximum working pressure for the Hose. Surge pressures and peak pressures can usually only be determined by sensitive electrical instrumentation that measures and indicates pressures at millisecond intervals. Mechanical pressure gauges indicate only average pressures and cannot be used to determine surge pressures or peak transient pressures. Published burst pressure ratings for Hose is for manufacturing test purposes only and is no indication that the Product can be used in applications at the burst pressure or otherwise above the published maximum recommended working pressure.
- 2.3 Suction: Hoses used for suction applications must be selected to insure that the
- Hose will withstand the vacuum and pressure of the system. Improperly selected Hose may collapse in suction application.
- 2.4 Temperature: Be certain that fluid and ambient temperatures, both steady and transient, do not exceed the limitations of the Hose. Temperatures below and above the recommended limit can degrade Hose to a point where a failure may occur and release fluid. Properly insulate and protect the Hose Assembly when routing near hot objects (e.g. manifolds). Do not use any Hose in any application where failure of the Hose could result in the conveyed fluids (or vapors or mist from the conveyed fluids) contacting any open flame, molten metal, or other potential fire ignition source that could cause burning or explosion of the conveyed fluids or vapors.
- 2.5 Fluid Compatibility: Hose Assembly selection must assure compatibility of the Hose tube, cover, reinforcement, and Fittings with the fluid media used. See the fluid compatibility chart in the Parker publication for the product being considered or used. This information is offered only as a guide. Actual service life can only be determined by the end user by testing under all extreme conditions and other analysis. Hose that is chemically compatible with a particular fluid must be assembled using Fittings and adapters containing likewise compatible seals.
- 2.6 Permeation: Permeation (that is, seepage through the Hose) will occur from inside the Hose to outside when Hose is used with gases, liquid and gas fuels, and refrigerants (including but not limited to such materials as helium, diesel fuel, gasoline, natural gas, or LPG). This permeation may result in high concentrations of vapors which are potentially flammable, explosive, or toxic, and in loss of fluid. Dangerous explosions, fires, and other hazards can result when using the wrong Hose for such applications. The system designer must take into account the fact that this permeation will take place and must not use Hose if this permeation could be hazardous. The system designer must take into account all legal, government,

insurance, or any other special regulations which govern the use of fuels and refrigerants. Never use a Hose even though the fluid compatibility is acceptable without considering the potential hazardous effects that can result from permeation through the Hose Assembly.

Permeation of moisture from outside the Hose to inside the Hose will also occur in Hose assemblies, regardless of internal pressure. If this moisture permeation would have detrimental effects (particularly, but not limited to refrigeration and air conditioning systems), incorporation of sufficient drying capacity in the system or other appropriate system safeguards should be selected and used.

- 2.7 Size: Transmission of power by means of pressurized fluid varies with pressure and rate of flow. The size of the components must be adequate to keep pressure losses to a minimum and avoid damage due to heat generation or excessive fluid velocity.
- 2.8 Routing: Attention must be given to optimum routing to minimize inherent problems (kinking or flow restriction due to Hose collapse, twisting of the Hose, proximity to hot objects or heat sources).
- 2.9 Environment: Care must be taken to insure that the Hose and Fittings are either compatible with or protected from the environment (that is, surrounding conditions) to which they are exposed. Environmental conditions including but not limited to ultraviolet radiation, sunlight, heat, ozone, moisture, water, salt water, chemicals, and air pollutants can cause degradation and premature failure.
- 2.10 Mechanical Loads: External forces can significantly reduce Hose life or cause failure. Mechanical loads which must be considered include excessive flexing, twist, kinking, tensile or side loads, bend radius, and vibration. Use of swivel type Fittings or adapters may be required to insure no twist is put into the Hose. Unusual applications may require special testing prior to Hose selection.
- 2.11 Physical Damage: Care must be taken to protect Hose from wear, snagging, kink-

ing, bending smaller than minimum bend radius, and cutting, any of which can cause premature Hose failure. Any Hose that has been kinked or bent to a radius smaller than the minimum bend radius, and any Hose that has been cut or is cracked or is otherwise damaged, should be removed and discarded.

- 2.12 Proper End Fitting: See instructions 3.2 through 3.5. These recommendations may be substantiated by testing to industry standards such as SAE J517 for hydraulic applications, or MIL-A-5070, AS1339, or AS3517 for Hoses from Parker's Stratoflex Products Division for aerospace applications.
- 2.13 Length: When establishing a proper Hose length, motion absorption, Hose length changes due to pressure, and Hose and machine tolerances and movement must be considered.
- 2.14 Specifications and Standards: When selecting Hose and Fittings, government, industry, and Parker specifications and recommendations must be reviewed and followed as applicable.
- 2.15 Hose Cleanliness: Hose components may vary in cleanliness levels. Care must be taken to insure that the Hose Assembly selected has an adequate level of cleanliness for the application.
- 2.16 Fire Resistant Fluids: Some fire resistant fluids that are to be conveyed by Hose require use of the same type of Hose as used with petroleum base fluids. Some such fluids require a special Hose, while a few fluids will not work with any Hose at all. See instructions 2.5 and 1.5. The wrong Hose may fail after a very short service. In addition, all liquids but pure water may burn fiercely under certain conditions, and even pure water leakage may be hazardous.
- 2.17 Radiant Heat: Hose can be heated to destruction without contact by such nearby items as hot manifolds or molten metal. The same heat source may then initiate a fire. This can occur despite the presence of cool air around the Hose.

- 2.18 **Welding or Brazing:** When using a torch or arc welder in close proximity to hydraulic lines, the hydraulic lines should be removed or shielded with appropriate fire resistant materials. Flame or weld spatter could burn through the Hose and possibly ignite escaping fluid resulting in a catastrophic failure. Heating of plated parts, including Hose Fittings and adapters, above 232 °C (450 °F) such as during welding, brazing, or soldering may emit deadly gases.
- 2.19 **Atomic Radiation:** Atomic radiation affects all materials used in Hose assemblies. Since the long-term effects may be unknown, do not expose Hose assemblies to atomic radiation.
- 2.20 **Aerospace Applications:** The only Hose and Fittings that may be used for in-flight aerospace applications are those available from Parker's Stratoflex Products Division. Do not use any other Hose or Fittings for in-flight applications. Do not use any Hose or Fittings from Parker's Stratoflex Products Division with any other Hose or Fittings, unless expressly approved in writing by the engineering manager or chief engineer of Stratoflex Products Division and verified by the user's own testing and inspection to aerospace industry standards.
- 2.21 **Unlocking Couplings:** Ball locking couplings or other couplings with disconnect sleeves can unintentionally disconnect if they are dragged over obstructions or if the sleeve is bumped or moved enough to cause disconnect. Threaded couplings should be considered where there is a potential for accidental uncoupling.
- 3.0 HOSE AND FITTING ASSEMBLY AND INSTALLATION INSTRUCTIONS**
- 3.1 **Component Inspection:** Prior to assembly, a careful examination of the Hose and Fittings must be performed. All components must be checked for correct style, size, catalog number, and length. The Hose must be examined for cleanliness, obstructions, blisters, cover looseness, kinks, cracks, cuts or any other visible defects. Inspect the Fitting and sealing surfaces for burrs, nicks, corrosion or other imperfections. Do NOT use any component that displays any signs of nonconformance.
- 3.2 **Hose and Fitting Assembly:** Do not assemble a Parker Fitting on a Parker Hose that is not specifically listed by Parker for that Fitting, unless authorized in writing by the engineering manager or chief engineer of the appropriate Parker division. Do not assemble a Parker Fitting on another manufacturer's Hose or a Parker Hose on another manufacturer's Fitting unless (i) the engineering manager or chief engineer of the appropriate Parker division approves the Assembly in writing or that combination is expressly approved in the appropriate Parker literature for the specific Parker product, and (ii) the user verifies the Assembly and the application through analysis and testing. For Parker Hose that does not specify a Parker Fitting, the user is solely responsible for the selection of the proper Fitting and Hose Assembly procedures. See instruction 1.4. The Parker published instructions must be followed for assembling the Fittings on the Hose. These instructions are provided in the Parker Fitting catalog for the specific Parker Fitting being used, or by calling 1-800-CPARKER, or at www.parker.com.
- 3.3 **Related Accessories:** Do not crimp or swage any Parker Hose or Fitting with anything but the listed swage or crimp machine and dies in accordance with Parker published instructions. Do not crimp or swage another manufacturer's Fitting with a Parker crimp or swage die unless authorized in writing by the engineering manager or chief engineer of the appropriate Parker division.
- 3.4 **Parts:** Do not use any Parker Fitting part (including but not limited to socket, shell, nipple, or insert) except with the correct Parker mating parts, in accordance with Parker published instructions, unless authorized in writing by the engineering manager or chief engineer of the appropriate Parker division.
- 3.5 **Reusable/Permanent:** Do not reuse any field attachable (reusable) Hose Fitting that has blown or pulled off a Hose. Do not reuse a Parker permanent Hose Fitting (crimped or

swaged) or any part thereof. Complete Hose Assemblies may only be reused after proper inspection under section 4.0. Do not assemble Fittings to any previously used hydraulic Hose that was in service, for use in a fluid power application.

- 3.6 Pre-Installation Inspection: Prior to installation, a careful examination of the Hose Assembly must be performed. Inspect the Hose Assembly for any damage or defects. Do NOT use any Hose Assembly that displays any signs of nonconformance.
- 3.7 Minimum Bend Radius: Installation of a Hose at less than the minimum listed bend radius may significantly reduce the Hose life. Particular attention must be given to preclude sharp bending at the Hose to Fitting juncture. Any bending during installation at less than the minimum bend radius must be avoided. If any Hose is kinked during installation, the Hose must be discarded.
- 3.8 Twist Angle and Orientation: Hose Assembly installation must be such that relative motion of machine components does not produce twisting.
- 3.9 Securement: In many applications, it may be necessary to restrain, protect, or guide the Hose to protect it from damage by unnecessary flexing, pressure surges, and contact with other mechanical components. Care must be taken to insure such restraints do not introduce additional stress or wear points.
- 3.10 Proper Connection of Ports: Proper physical installation of the Hose Assembly requires a correctly installed port connection insuring that no twist or torque is transferred to the Hose when the Fittings are being tightened or otherwise during use.
- 3.11 External Damage: Proper installation is not complete without insuring that tensile loads, side loads, kinking, flattening, potential abrasion, thread damage, or damage to sealing surfaces are corrected or eliminated. See instruction 2.10.
- 3.12 System Checkout: All air entrapment must be eliminated and the system pressurized to

the maximum system pressure (at or below the Hose maximum working pressure) and checked for proper function and freedom from leaks. Personnel must stay out of potential hazardous areas while testing and using.

- 3.13 Routing: The Hose Assembly should be routed in such a manner so if a failure does occur, the escaping media will not cause personal injury or property damage. In addition, if fluid media comes in contact with hot surfaces, open flame, or sparks, a fire or explosion may occur. See section 2.4.

4.0 HOSE AND FITTING MAINTENANCE AND REPLACEMENT INSTRUCTIONS

- 4.1 Even with proper selection and installation, Hose life may be significantly reduced without a continuing maintenance program. The severity of the application, risk potential from a possible Hose failure, and experience with any Hose failures in the application or in similar applications should determine the frequency of the inspection and the replacement for the Products so that Products are replaced before any failure occurs. A maintenance program must be established and followed by the user and, at minimum, must include instructions 4.2 through 4.7.
- 4.2 Visual Inspection Hose/Fitting: Any of the following conditions require immediate shut down and replacement of the Hose Assembly:
- Fitting slippage on Hose;
 - Damaged, cracked, cut or abraded cover (any reinforcement exposed);
 - Hard, stiff, heat cracked, or charred Hose;
 - Cracked, damaged, or badly corroded Fittings;
 - Leaks at Fitting or in Hose;
 - Kinked, crushed, flattened or twisted Hose; and
 - Blistered, soft, degraded, or loose cover.
- 4.3 Visual Inspection All Other: The following items must be tightened, repaired, corrected or replaced as required:
- Leaking port conditions;
 - Excess dirt buildup;
 - Worn clamps, guards or shields; and
 - System fluid level, fluid type, and any air entrapment.

- 4.4 **Functional Test:** Operate the system at maximum operating pressure and check for possible malfunctions and leaks. Personnel must avoid potential hazardous areas while testing and using the system. See section 2.2.
- 4.5 **Replacement Intervals:** Hose assemblies and elastomeric seals used on Hose Fittings and adapters will eventually age, harden, wear and deteriorate under thermal cycling and compression set. Hose Assemblies and elastomeric seals should be inspected and replaced at specific replacement intervals, based on previous service life, government or industry recommendations, or when failures could result in unacceptable downtime, damage, or injury risk. See section 1.2.
- 4.6 **Hose Inspection and Failure:** Hydraulic power is accomplished by utilizing high-pressure fluids to transfer energy and do work. Hoses, Fittings, and Hose Assemblies all contribute to this by transmitting fluids at high pressures. Fluids under pressure can be dangerous and potentially lethal and, therefore, extreme caution must be exercised when working with fluids under pressure and handling the Hoses transporting the fluids. From time to time, Hose Assemblies will fail if they are not replaced at proper time intervals. Usually these failures are the result of some form of misapplication, abuse, wear, or failure to perform proper maintenance. When Hoses fail, generally the high-pressure fluids inside escape in a stream which may or may not be visible to the user. Under no circumstances should the user attempt to locate the leak by “feeling” with their hands or any other part of their body. High-pressure fluids can and will penetrate the skin and cause severe tissue damage and possibly loss of limb. Even seemingly minor hydraulic fluid injection injuries must be treated immediately by a physician with knowledge of the tissue damaging properties of hydraulic fluid. If a Hose failure occurs, immediately shut down the equipment and leave the area until pressure has been completely released from the Hose Assembly. Simply shutting down the hydraulic pump may or may not eliminate the pressure in the Hose Assembly. Many times check valves, etc., are employed in a system and can cause pressure to remain in a Hose Assembly even when pumps or equipment are not operating. Tiny holes in the Hose, commonly known as pinholes, can eject small, dangerously powerful but hard to see streams of hydraulic fluid. It may take several minutes or even hours for the pressure to be relieved so that the Hose Assembly may be examined safely. Once the pressure has been reduced to zero, the Hose Assembly may be taken off the equipment and examined. It must always be replaced if a failure has occurred. Never attempt to patch or repair a Hose Assembly that has failed. Consult the nearest Parker distributor or the appropriate Parker division for Hose Assembly replacement information. Never touch or examine a failed Hose Assembly unless it is obvious that the Hose no longer contains fluid under pressure. The high-pressure fluid is extremely dangerous and can cause serious and potentially fatal injury.
- 4.7 **Elastomeric seals:** Elastomeric seals will eventually age, harden, wear and deteriorate under thermal cycling and compression set. Elastomeric seals should be inspected and replaced.
- 4.8 **Refrigerant gases:** Special care should be taken when working with refrigeration systems. Sudden escape of refrigerant gases can cause blindness if the escaping gases contact the eye and can cause freezing or other severe injuries if it contacts any other portion of the body.
- 4.9 **Compressed natural gas (CNG):** Parker CNG Hose Assemblies should be tested after installation and before use, and at least on a monthly basis per AGA 1-93 Section 4.2 “Visual Inspection Hose/Fitting”. The recommended procedure is to pressurize the Hose and check for leaks and to visually inspect the Hose for damage. Caution: Matches, candles, open flame or other sources of ignition shall not be used for Hose inspection. Leak check solutions should be rinsed off after use.

Glossary

Abrasion

Abrasion occurs in numerous forms; two of the more common are the typical rubbing or chafing, with the second being very high frequency, low amplitude friction. This type of abrasion results from pump pressure pulses otherwise known as pump ripple. It can also be caused by equipment vibration or resonance. Abrasion may occur when two hose lines cross or when a hose line rubs or bears against a fixed point. Abrasion resistance is also a function of temperature and attack of the cover material by aggressive chemicals. Spring guards or other protective sleeving can also ward off premature hose failure resulting from abrasion. Spring guards also distribute bending force often associated with excessive side loading or even kinking at the skirt of the coupling.

Ambient temperature

Exceedingly high or low ambient temperatures will affect the materials from which the hose is constructed and will negatively influence hose life. When at all possible, the hose should be routed in such a manner as to protect it from heat sources. In extreme cold applications, the equipment should be designed with remote relief valves to allow circulation and warming of the oil before hose articulation is attempted. The hose liner (core tube) of choice for extremely high or low temperature is Teflon®. Teflon® is serviceable at temperatures as low as -100°F and as high as +450°. Consult the specific hose operating parameters for more information.

Bend radius

The minimum bend radii listed in this catalog are valid at rated working pressures and indicated service temperatures. Service life of a hose may be shortened if the minimum radius is exceeded or if the hose is flexed continuously in use.

Burst pressure and working pressure

The specified burst pressure for each hose style and dash size are for unaged hoses tested at normal laboratory temperature in accordance with SAE J343 specification for normal service and technically ideal installations. The maximum recommended working pressure is 1/4 of the mini-

mum rated burst pressure, except as otherwise specifically stated in those product specifications. For more severe service, a higher rated working pressure hose may have to be selected.

Hose installation tips

Establish hose size (I. D.) and style based upon flow rate (GPM), pressure drop, and chemical compatibility with fluid medium. Other significant factors to be considered in hose selection and installation are discussed briefly as follows:

Operating temperature

The temperature range for satisfactory service (maximum hose life) depends to a great extent upon the fluid being conveyed. Use of a hose above maximum specified temperature ratings will shorten hose life due, but not limited, to oxidation, chemical degradation and loss of compression within the coupling.

Pressure effects

Pressure surges and system shocks (spikes) are common in hydraulic systems. The normal 4:1 safety factor should reflect these transient pressures. Where these surges and shocks are considered severe or hazardous, the safety factor should be increased.

When hose is under pressure, it may change in length by as much as $\pm 3\%$. Installation should compensate for shortening by providing an appropriate amount of slack and for lengthening by allowing space for this growth to be absorbed.

Routing and clamping

Whenever possible, and maximum efforts should be made to do so, hose should be routed to flex in a single plane. Routing hoses in flexure through compound bends results in torsions. When this is unavoidable, the torsion should be distributed over the maximum hose length possible. Wire reinforced hoses suffer the most rapid and severe loss of service life when applied in torsion. Extremely tight and improperly located clamps focus this torsion over short distances.

Analysis of the hose function is required before

the proper clamping techniques can be selected. In some applications, hoses must be contained to stay out of harm's way and at the same time be free to come and go with equipment articulation. Other applications may require restrictive clamping, in which case a protective material should be used around the hose to provide the grasp without deformation of the hose by the clamp. These techniques also apply to the use of the popular method of clamping and clustering hoses with plastic tie straps.

Parker swivel adaptors feature 360° swiveling action that especially suits them for use in applications where hose moves, bends or twists. Swivel adapters connected to hose assemblies relieve twisting, prevent excessive flexing of hose, eliminate need for long radius bends, and cushion intraline shock caused by peak system pressure pulses.

High pressure adapters

It is critical that the adapter material be properly suited to the fluid media. Widely varying conditions frequently necessitate high pressure adapters constructed of materials other than conventional 316 stainless steel. Since many variables affect the corrosion resistance of metallic materials, it is Parker Hannifin's policy not to recommend materials based on corrosion resistance for specific fluid applications. The published recommended working pressure represent the capability of the subject fitting. Nevertheless, in some instances, the hose, hose fitting or other connector assembled to the adapter may dictate the maximum working pressure. The end-user should read and understand the Parker Safety Guide (Bulletin 4400-B.1) and follow its suggested practices and warnings.

Chapter K**Index of part numbers**

Index	K-2
-------------	-----

Index of part numbers

Part number	page
015301	I-4
015306	I-4
015307	I-4
015308	I-4
015309	I-4
015736	I-4
10155-4-3C	D-3
10155-4-4C	D-3
10155-4-5C	D-3
10155-6-5C	D-3
10155-6-6C	D-3
10155-8-8C	D-3
1018X-4-04C	D-6
1018X-6-05C	D-6
1018X-6-06C	D-6
1018X-8-08C	D-6
101BL-32-32	E-6, E-9, E-12
1063X-6-6C	B-3
10655-4-3C	D-3
10655-4-4C	B-3, D-3
10655-5-5C	D-3
10655-6-5C	D-3
10655-6-6C	B-3, D-3
10655-8-8C	B-3, D-3
10658H-16-16C	C-3
1068X-10-08C	B-19, D-6
1068X-4-04C	B-13, B-19, B-37, B-43, D-6
1068X-6-04C	B-3, B-13, B-19, B-37, B-43, B-50, D-6
1068X-6-05C	D-6
1068X-8-06C	B-19, D-6
1069X-12-12C	B-22, B-47
1069X-16-16C	B-22, C-5
1069X-8-06C	B-22
1069X-8-08C	B-22, C-5
106LH-4-3C	C-3
106LV-4-3C	C-3
106LX-16-12C	B-25
106LX-16-12C-M	B-50
106LX-6-04C	B-25, D-9
106LX-6-06C	B-25, D-9
106LX-6-06C-M-Subsea	B-50
106LX-8-06C	B-25, D-9
106LX-8-06C-M-Subsea	B-50
106LX-8-08C	B-3, B-25, D-9
106LX-8-08C-M-Subsea	B-50
106NX-20-20C	B-19
106RX-4-04C	B-10, B-34
106RX-6-04C	B-10, B-34
106RX-6-06C	B-16, B-40
1923X-8-06C	B-4
19255-4-3C	D-4

Part number	page
19255-4-4C	B-4, D-4
19255-6-5C	D-4
19255-6-6C	B-4, D-4
19255-8-8C	B-4, D-4
1928X-4-04C	B-4, B-13, B-19, B-37, B-44, D-7
1928X-6-06C	B-19, D-7
1928X-8-08C	B-19, D-7
1929X-12-12C	B-22, B-47
1929X-16-16C	B-22, C-5
1929X-6-06C	B-22
1929X-8-08C	B-22, C-5
192LX-8-08C	B-4
192NX-24-20C	B-19
192RX-4-04C	B-10, B-34
192RX-6-06C	B-16, B-40
1AY5X-11-08C-M-Subsea	B-54
1AY8X-6-04C	B-6, B-20, B-29, B-38, B-43, D-7
1AY8X-8-06C	B-29
1AY9X-16-12C	B-48
1AYLX-11-8C	B-27
1AYLX-16-12C	B-27
1AYLX-6-04C	B-27
1AYLX-8-6C	B-27
1AYUX-6-04C	B-52
1AYUX-8-05C	B-52
1AYUX-8-06C	B-52
1C93X-14-06C	B-5
1C93X-16-06C	B-5
1C955-10-4C	B-5, D-4
1C955-12-4C	B-5
1C955-12-5C	D-4
1C955-12-6C	B-5, D-4
1C955-16-8C	B-5, D-4
1C955-8-4C	B-5
1C95X-16-08C-M-Subsea	B-54
1C95X-38-24COSK	E-12
1C95X-38-24COSK-TC	E-6, E-9
1C98X-10-04C	B-5, B-14, B-20, B-38, B-44, B-50
1C98X-12-06C	B-20
1C98X-16-08C	B-20
1C98X-8-04C	B-5, B-14, B-20, B-38, B-44, B-50
1C99X-12-06C	B-23
1C99X-16-08C	B-23, C-6
1C99X-25-12C	B-23, B-48
1C99X-30-16C	B-23, C-6
1C9LX-10-04C	B-26, D-10
1C9LX-14-06C	B-26, D-10
1C9LX-14-06C-M-Subsea	B-50
1C9LX-16-08C	B-5, B-26, D-10
1C9LX-16-08C-M-Subsea	B-50
1C9LX-25-12C	B-26

Part number	page	Part number	page
1C9LX-25-12C-M	B-50	2440M-06V30	B-49
1C9NX-38-20C	B-20	2440M-08V30	B-49, J-5
1C9RX-10-04C	B-11, B-35	2440M-12V30	B-49, J-5
1C9RX-12-06C	B-17, B-41	2440M-16V30	B-49
1C9RX-8-04C	B-11, B-35	2440N-04V37	D-8
1HEBL-32-32	E-7, E-10, E-13	2440N-04V91	B-24, J-3
1HNBL-32-32	E-7, E-10, E-13	2440N-06V37	D-8
1Y25X-12-08C-M-Subsea	B-55	2440N-06V91	B-24, J-3
1Y25X-9-08C-M-Subsea	B-55	2440N-08V37	D-8
1Y28X-6-04C	B-29, B-45	2440N-08V91	B-24, J-3
1Y28X-9-06C	B-29	2440N-12V37	D-8
1Y2LX-6-04M-INC625	B-45	2440N-12V91	B-24, J-3
1Y2UX-6-04C	B-52	2440N-16V37	D-8
1Y2UX-6-05C	B-52	2440N-16V80	E-5, J-4
1Y2UX-9-06C	B-52	2440N-16V91	B-24, J-3
2022N-04V91-10K	B-2, J-6	2440N-24V80	E-5, J-4
2022N-04V91-5K	B-2, J-6	2448M-04V30	B-51, J-4
2022N-06V91-10K	B-2, J-6	2448M-05V30	B-51, J-5
2022N-06V91-5K	B-2, J-6	2448M-06V30	B-51, J-5
2022N-08V91-10K	B-2, J-6	2448M-32V80	E-11, J-5
2022N-08V91-5K	B-2, J-6	2448N-04V91	B-28, J-3
2240M-04V30	B-33, J-4	2448N-06V91	B-28, J-3
2240N-04V91	B-9, J-3	2448N-32V80	E-5, J-4
2340M-04V30	B-36, J-4	2580M-32V80	E-11, J-5
2340N-04V91	B-12, J-3	2580N-32V80	J-4
2370M-06V30	B-39, J-5	2580N-32V80**	E-8
2370N-06V91	B-15, J-3	2640M-08V30	B-53, J-5
2380M-04V30	B-42, J-4	2640M-16V80	E-11, J-5
2380M-05V30	B-42, J-4	2640M-24V80	E-11, J-5
2380N-04V00	D-5	2640N-08V91	B-30, J-3
2380N-04V02	D-5	2640N-12V91	B-30, J-3
2380N-04V04	D-5	2640N-16V80	E-8, J-4
2380N-04V91	B-18, J-3	2640N-16V91	B-30, J-3
2380N-06V10	D-5	2640N-24V80	E-8, J-4
2380N-06V91	B-18, J-3	2640N-48V80	E-8, J-4
2380N-08V10	D-5	520N-3	D-2
2380N-08V91	B-18, J-3	520N-4	D-2
2380N-20V91	B-18, J-3	520N-5	D-2
2390M-12V30	B-46, J-5	520N-6	D-2
2390M-16V30	B-46	520N-8	D-2
2390N-06V91	B-21, J-3	573LH-3	C-2
2390N-08V12	C-4	575LH-3	C-2
2390N-08V13	C-4	575X-16	C-2
2390N-08V16	C-4	57CRN-08V02	B-7, J-6
2390N-08V91	B-21, J-3	57CRN-16V02	B-7, J-6
2390N-12V91	B-21, J-3	6015X-32-24-TC	E-9, E-12
2390N-16V12	C-4	606CR-16-16C	B-8
2390N-16V16	C-4	606CR-8-8C	B-8
2390N-16V91	B-21, J-3	606LX-16-12C	D-9
2440M-04V30	B-49, J-4	606LX-16-16C	B-25, D-9
2440M-05V30	B-49, J-4	606LX-6-04C-M-Subsea	B-43

Index

Part number	page
6AY5X-11-8C	B-31
6AY5X-16-12C	B-31
6AY5X-16-12C-SD	B-31
6AY5X-16-16C	B-31
6AY5X-16-16C-SD	B-31
6AY9X-11-8C	B-23, C-6
6AY9X-16-12C	B-23
6AY9X-16-16C	B-23, C-6
6AY9X-8-6C	B-23
6AYHX-16-16C-TC	E-9, E-12
6AYLX-11-8C	D-11
6AYLX-11-8C-SD	B-27, D-11
6AYLX-16-12C	D-11
6AYLX-16-12C-SD	B-27, D-11
6AYLX-16-16C	B-27, D-11
6AYLX-16-16C-SD	B-27, D-11
6AYLX-6-4C	D-11
6AYLX-6-4C-M-Subsea	B-43
6AYLX-6-4C-SD	B-27, D-7, D-11
6AYLX-8-5C	D-7
6AYLX-8-6C	D-11
6C95X-16-08C	B-32
6C95X-25-12C	B-32
6C95X-30-16C	B-32
6C9HX-30-16C-TC	E-9, E-12
6C9LX-25-12C	D-10
6C9LX-30-16C	D-10
6C9LX-30-16C*	B-26
6HE5X-32-24-TC	E-10, E-13
6HN5X-32-24-TC	E-10, E-13
6Y25X-12-8C	B-31
6Y25X-16-12C	B-31
6Y25X-9-8C	B-31
6Y2LX-6-4C-M-Subsea	B-45
80C-F04G	I-3
80C-F06G	I-3
80C-F08G	I-3
80C-F10G	I-3
80C-F12G	I-3
80C-G03	I-3
80C-G04	I-3
80C-G06	I-3
80C-HP3	I-3
80C-HP4	I-3
80C-HP6	I-3
82C-R01-PFD	I-4
82C-R02-PFD	I-4
83C-081-PFD	I-4
83C-9X04	I-3
83C-9X08	I-3
83C-9X16	I-3

Part number	page
83C-F08W	I-3
83C-F16G	I-3
83C-F16W	I-3
94C-080-PFD	I-4
BSC-1	I-4
E213JFC4	B-22, C-5
E225JIC3	B-22, C-5
H580N-16	C-2
HP-3-Gauge	I-3
HP-4-Gauge	I-3
HP-6-Gauge	I-3
HS-03	I-2
HS-05	I-2
HS-08	I-2
HS-12	I-2
HS-16	I-2
HS-20	I-2
HS-28	I-2
HS-32	I-2
MK022-03-038	I-2
MK022-03-039	I-2
MK022-03-041	I-2
MK022-03-042	I-2
MK022-03-043	I-2
MK022-03-045	I-2
MSG060	I-2
MSG1006	I-2
MSG2006	I-2
MSG2106	I-2
MSG4113	I-2
MSG4120	I-2
MSG4125	I-2
MSG6020	I-2
MTM04T	I-2

Part number	page	Part number	page

Parker's Motion & Control Technologies

At Parker, we're guided by a relentless drive to help our customers become more productive and achieve higher levels of profitability by engineering the best systems for their requirements. It means looking at customer applications from many angles to find new ways to create value. Whatever the motion and control technology need, Parker has the experience, breadth of product and global reach to consistently deliver. No company knows more about motion and control technology than Parker. For further info call 00800 27 27 5374

AEROSPACE

- Key Markets**
- Aircraft engines
 - Business & general aviation
 - Commercial transports
 - Land-based weapons systems
 - Military aircraft
 - Missiles & launch vehicles
 - Regional transports
 - Unmanned aerial vehicles

Key Products

- Flight control systems
- Fuel components
- Fuel gas systems
- Fluid metering delivery
- Fluid metering devices
- Fuel systems & components
- Hydraulic systems & components
- Inert nitrogen generating systems
- Pneumatic systems & components
- Wheels & brakes



CLIMATE CONTROL

- Key Markets**
- Agriculture
 - Air conditioning
 - Food, beverage & dairy
 - Life & medical sciences
 - Precision cooling
 - Processing
 - Transportation

Key Products

- CO₂ controls
- Electronic controllers
- Filter components
- High start-off valves
- Hise & fittings
- Pressure regulating valves
- Refrigerant distributors
- Safety relief valves
- Solenoid valves
- Thermostatic expansion valves



ELECTROMECHANICAL

- Key Markets**
- Aerospace
 - Factory automation
 - Life science & medical
 - Machine tools
 - Packaging machinery
 - Paper machinery
 - Plastics machinery & converting
 - Primary metals
 - Semiconductor & electronics
 - Textiles
 - Wire & cable

Key Products

- ACPD drives & systems
- Electric actuators, gantry robots & drives
- Electrostatic actuation systems
- Electromechanical actuation systems
- Human machine interface
- Linear motors
- Stepper motors, servo motors, drives & controls
- Structural extrusions



FILTRATION

- Key Markets**
- Food & beverage
 - Industrial machinery
 - Life sciences
 - Marine
 - Mobile equipment
 - Oil & gas
 - Power generation
 - Process
 - Transportation

Key Products

- Analytical gas generators
- Compressed air & gas filters
- Condition monitoring
- Engine air, fuel & oil filtration
- Filtration systems
- Hydraulic, lubrication & coolant filters
- Process, chemical, water & microfiltration filters
- Nitrogen, hydrogen & zero air generators



FLUID & GAS HANDLING

- Key Markets**
- Aerospace
 - Agriculture
 - Bulk chemical handling
 - Construction machinery
 - Food & beverage
 - Fuel & gas delivery
 - Industrial machinery
 - Mobile
 - Oil & gas
 - Power generation
 - Welding

Key Products

- Back fittings & valves
- Diagnostic equipment
- Fluid compliance systems
- Industrial hose
- PTFE & PFA hose, tubing & plastic fittings
- Rubber & thermoplastic hose & couplings
- Tube fittings & adapters
- Quick disconnects



HYDRAULICS

- Key Markets**
- Aerospace
 - Aerial lift
 - Agriculture
 - Construction machinery
 - Heavy machinery
 - Mineral machinery
 - Oil & gas
 - Power generation & energy
 - Truck/hydraulics

Key Products

- Diagnostic equipment
- Hydraulic cylinders
- Accumulators
- Hydraulic motors & pumps
- Hydraulic systems
- Hydraulic valves & controls
- Power take-offs
- Rubber & thermoplastic hose
- Tube fittings & adapters
- Quick disconnects



PNEUMATICS

- Key Markets**
- Aerospace
 - Conveyor & material handling
 - Factory automation
 - Life science & medical
 - Machine tools
 - Packaging machinery
 - Transportation & automotive

Key Products

- Air preparation
- Brass fittings & valves
- Manifolds
- Pneumatic accessories
- Pneumatic actuators & grippers
- Pneumatic valves & controls
- Quick disconnects
- Rotary actuators
- Rubber & thermoplastic hose & couplings
- Structural extrusions
- Thermoplastic tubing & fittings
- Vacuum generators, cups & sensors



SEALING & SHIELDING

- Key Markets**
- Aerospace
 - Chemical processing
 - Consumer
 - Energy, oil & gas
 - Fluid power
 - General industrial
 - Information technology
 - Life sciences
 - Military
 - Semiconductor
 - Telecommunications
 - Transportation

Key Products

- Dynamic seals
- Elastomeric o-rings
- EM shielding
- Extruded & precision-cut, fabricated elastomeric seals
- Homogeneous & inserted elastomeric shapes
- High temperature metal seals
- Metal & plastic retained composite seals
- Thermal management



PROCESS CONTROL

- Key Markets**
- Chemical & refining
 - Food, beverage & dairy
 - Medical & dental
 - Microelectronics
 - Oil & gas
 - Power generation

Key Products

- Analytical sample conditioning products & systems
- Monopolymer chemical delivery fittings, valves & pumps
- High purity delivery fittings, valves & regulators
- Instrumentation fittings, valves & regulators
- Medium pressure fittings & valves
- Process control manifolds



ENGINEERING YOUR SUCCESS.

Parker Worldwide

AE – UAE, Dubai
Tel: +971 4 8127100
parker.me@parker.com

AR – Argentina, Buenos Aires
Tel: +54 3327 44 4129

AT – Austria, Wiener Neustadt
Tel: +43 (0)2622 23501-0
parker.austria@parker.com

AT – Eastern Europe, Wiener Neustadt
Tel: +43 (0)2622 23501 900
parker.easturope@parker.com

AU – Australia, Castle Hill
Tel: +61 (0)2-9634 7777

AZ – Azerbaijan, Baku
Tel: +994 50 2233 458
parker.azerbaijan@parker.com

BE/LU – Belgium, Nivelles
Tel: +32 (0)67 280 900
parker.belgium@parker.com

BR – Brazil, Cachoeirinha RS
Tel: +55 51 3470 9144

BY – Belarus, Minsk
Tel: +375 17 209 9399
parker.belarus@parker.com

CA – Canada, Milton, Ontario
Tel: +1 905 693 3000

CH – Switzerland, Etoy
Tel: +41 (0) 21 821 02 30
parker.switzerland@parker.com

CL – Chile, Santiago
Tel: +56 2 623 1216

CN – China, Shanghai
Tel: +86 21 2899 5000

CZ – Czech Republic, Klecany
Tel: +420 284 083 111
parker.czechrepublic@parker.com

DE – Germany, Kaarst
Tel: +49 (0)2131 4016 0
parker.germany@parker.com

DK – Denmark, Ballerup
Tel: +45 43 56 04 00
parker.denmark@parker.com

ES – Spain, Madrid
Tel: +34 902 330 001
parker.spain@parker.com

FI – Finland, Vantaa
Tel: +358 (0)20 753 2500
parker.finland@parker.com

FR – France, Contamine s/Arve
Tel: +33 (0)4 50 25 80 25
parker.france@parker.com

GR – Greece, Athens
Tel: +30 210 933 6450
parker.greece@parker.com

HK – Hong Kong
Tel: +852 2428 8008

HU – Hungary, Budapest
Tel: +36 1 220 4155
parker.hungary@parker.com

IE – Ireland, Dublin
Tel: +353 (0)1 466 6370
parker.ireland@parker.com

IN – India, Mumbai
Tel: +91 22 6513 7081-85

IT – Italy, Corsico (MI)
Tel: +39 02 45 19 21
parker.italy@parker.com

JP – Japan, Tokyo
Tel: +(81) 3 6408 3901

KR – South Korea, Seoul
Tel: +82 2 559 0400

KZ – Kazakhstan, Almaty
Tel: +7 7272 505 800
parker.easturope@parker.com

LV – Latvia, Riga
Tel: +371 6 745 2601
parker.latvia@parker.com

MX – Mexico, Apodaca
Tel: +52 81 8156 6000

MY – Malaysia, Shah Alam
Tel: +60 3 7849 0800

NL – The Netherlands, Oldenzaal
Tel: +31 (0)541 585 000
parker.nl@parker.com

NO – Norway, Ski
Tel: +47 64 91 10 00
parker.norway@parker.com

NZ – New Zealand, Mt Wellington
Tel: +64 9 574 1744

PL – Poland, Warsaw
Tel: +48 (0)22 573 24 00
parker.poland@parker.com

PT – Portugal, Leca da Palmeira
Tel: +351 22 999 7360
parker.portugal@parker.com

RO – Romania, Bucharest
Tel: +40 21 252 1382
parker.romania@parker.com

RU – Russia, Moscow
Tel: +7 495 645-2156
parker.russia@parker.com

SE – Sweden, Spånga
Tel: +46 (0)8 59 79 50 00
parker.sweden@parker.com

SG – Singapore
Tel: +65 6887 6300

SK – Slovakia, Banská Bystrica
Tel: +421 484 162 252
parker.slovakia@parker.com

SL – Slovenia, Novo Mesto
Tel: +386 7 337 6650
parker.slovenia@parker.com

TH – Thailand, Bangkok
Tel: +662 717 8140

TR – Turkey, Istanbul
Tel: +90 216 4997081
parker.turkey@parker.com

TW – Taiwan, Taipei
Tel: +886 2 2298 8987

UA – Ukraine, Kiev
Tel: +380 44 494 2731
parker.ukraine@parker.com

UK – United Kingdom, Warwick
Tel: +44 (0)1926 317 878
parker.uk@parker.com

US – USA, Cleveland
Tel: +1 216 896 3000

VE – Venezuela, Caracas
Tel: +58 212 238 5422

ZA – South Africa, Kempton Park
Tel: +27 (0)11 961 0700
parker.southafrica@parker.com

